

Challenging wind and waves

Linking hydrodynamic research to the maritime industry

NAUTICAL ACCESSIBILITY MISSISSIPPIHAVEN

Final Report

Report No. : 29266-1-MSCN-rev.2
Date : April 5, 2016

Signature Management:



NAUTICAL ACCESSIBILITY MISSISSIPPIHAVEN

Final Report

Ordered by : Port of Rotterdam Authority
 P.O. Box 6622
 3002 AP Rotterdam

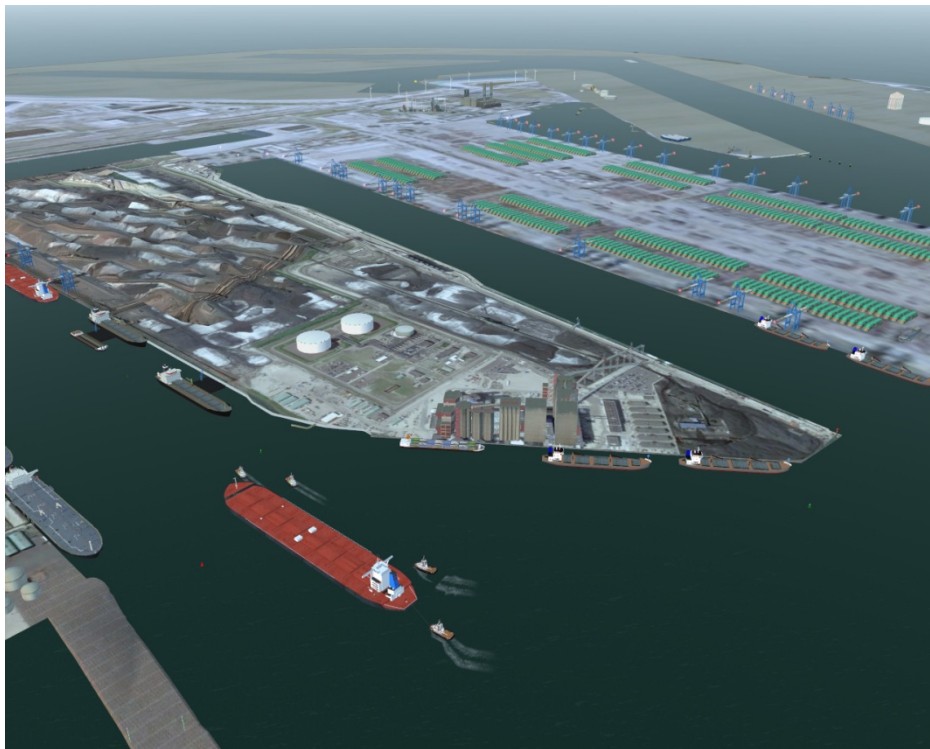

Revision no.	Status	Date	Author	Reviewed by
0	Draft Report	3 March 2016	D.J.E. van Heel	F.S.H. Verkerk
1	Draft Report	23 March 2016	D.J.E. van Heel	
2	Final Report	5 April 2016	D.J.E. van Heel	

CONTENTS	Page
ABBREVIATIONS	3
MANAGEMENT SUMMARY	4
1 INTRODUCTION.....	12
2 OBJECTIVES OF THE STUDY AND APPROACH	14
2.1 Objectives of the study.....	14
2.2 Approach and methodology	14
3 SIMULATOR DATABASE AND SHIP MODELS.....	15
3.1 Introduction	15
3.2 Dolphin.....	15
3.2.1 Layouts, visuals and depth contours	16
3.2.2 Moored ships	19
3.2.3 Current patterns.....	19
3.2.4 Wind fields	28
3.2.5 Wave fields	30
3.2.6 Modelling aspects of vessels.....	31
4 REAL-TIME SIMULATIONS.....	34
4.1 Introduction	34
4.2 Results of the validation day	35
4.3 Results of the simulations	36
4.4 Presentation of the results	37
4.5 Criteria for the analyses	42
4.5.1 Space used.....	42
4.5.2 Controllability	44
4.6 Discussion of the results	45
4.6.1 Arrivals with capesize bulk carrier	47
4.6.2 Arrivals with Vale Max bulk carrier	50
4.6.3 Departures with Vale Max bulk carrier	52
4.6.4 Arrivals with VLCC.....	53
4.7 Passing ship forces.....	56
5 CONCLUSIONS AND RECOMMENDATIONS.....	58
REFERENCES.....	60
APPENDIX A MARIN Simulators	
APPENDIX B Pilot cards	
APPENDIX C Track and data plots of real-time simulations	
APPENDIX D Assessment by simulator instructor	
APPENDIX E Questionnaires Pilots	

ABBREVIATIONS

ASCII	American Standard Code for Information Interchange
ASD	Azimuth Stern Drive
CFD	Computational Fluid Dynamics
CMS	Compact Manoeuvring Simulator
DIFFRAC/PRECAL	MARIN programs for 3D potential flow theory including wave Diffraction
DOF	Degrees of Freedom
DOLPHIN	MARIN simulation software
DNV	Det Norske Veritas
ECDIS	Electronic Chart Display and Information System
EMO	Europees Massaged Overslag BV
ENC	Electronical Nautical Chart
FMB	Full Mission Bridge simulator
IMO	International Maritime Organization
IOS	Instructor Operator Station
HLA	High Level Architecture
HW	High Water
RAPID	MARIN Program to calculate wave resistance and potential flow
ROPES	Research On Passing Effects on Ships
STCW	Standards of Training, Certification and Watchkeeping
UKC	Under Keel Clearance
VLCC	Very Large Crude Carrier
VLOC	Very Large Ore Carrier
XMF	eXtensible Modeling Framework

MANAGEMENT SUMMARY

A new terminal may be situated at the south side of the Mississippihaven at Maasvlakte 1. At this terminal liquid bulk will be transferred for which a petroleum regime has to be implemented. The limiting conditions at which ships can safely navigate the Beerkanaal have been determined previously but the new terminal and the associated petroleum regime may introduce additional limitations. Real-time manoeuvring simulations were performed to study the nautical consequences.

The objectives of the study are:

- Investigate the safety hazards of the moored vessels close to the turning basin (with respect to the petroleum regime to be implemented) and give suggestions for possible additional measures to lower the risks involved. This will be done by:
 - simulating an inbound vessel that has a black-out
 - simulating an inbound vessel with a failing stern tug
- Compared to the study mentioned in [1], the ships moored at the south side of the Mississippihaven have shifted 12 m to the north. Determine the impact of the new terminal on vessels destined for the EMO terminal:
 - given the maximum mooring configuration at the north and south side of the Mississippihaven and the horizontal tide limits that are currently in force, can a loaded Vale Max ship safely enter the Mississippihaven? If not make suggestions to minimum available fairway width and/or the limiting conditions.
 - can an empty Vale Max vessel safely departure from the EMO terminal with strong winds from NNW direction and with vessels moored at the south side of the Mississippihaven?
 - determine the mooring forces of vessels moored at the new terminal when VLOC pass.

Approach and methodology

The study started with a kick-off meeting with representatives of the Port of Rotterdam Authority and one of the pilots involved in this study. In this meeting MARIN presented the project approach. The setup and input parameters and scenarios were discussed and agreed upon. With this input and the data delivered by the client the simulator database was setup. This setup was tested and approved with some comments on the validation day. Prior to the actual simulations these comments were rectified in the database and final preparations were made. A three day simulator session was used to address the objectives of the study. The real-time simulations were carried out on Full-mission Bridge I (FMB I) in combination with a Compact Manoeuvring Simulator (CMS). The pilots own 'Navigator Marginal Ships' was connected to the simulator. To determine the mooring forces of vessels moored at the new terminal when a VLOC passes, calculations with ROPES software were carried out.

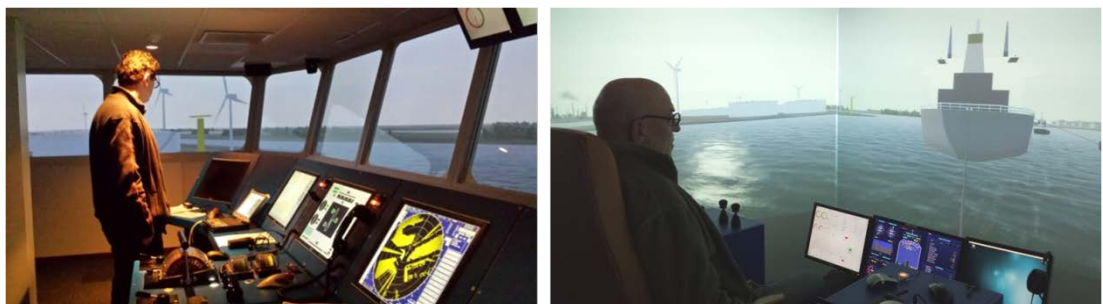

Picture taken on FMB I (left) and on CMS (right)

During the simulations regular debriefings were held to capture the results and to discuss the program in order to achieve the objectives of the study. On completion the simulations were analysed and evaluated. The results and conclusions are discussed in this report.

Database input

The properties of the ships and tugs used in this study are given below. The capesize bulk carrier was assisted by three tugs, the VLCC and Vale Max by four. The stern tug was always the tug steered by the tug captain. The other tugs were controlled via a tug-automat.

Properties of the design vessels

Property	unit	Vale Max	VLCC	Capesize bulk carrier
Length o.a.	[m]	362	332	292
Beam	[m]	65.0	58.0	45.0
Draught	[m]	22.55/14.0	21	18.5
Propeller	[-]	1	1	1
Deadweight	[ton]	400,000	284206	179900
Awx	[m ²]	1607/2160	1287	1250
Awy	[m ²]	4497/7549	3491	3189

Tug properties

Property	unit	Damen3211
Length o.a.	[m]	32.72
Beam	[m]	11.84
Draught	[m]	4.8
Propeller	[-]	2 ASD
Bollard Pull	[Tons]	60
Displacement	[Tons]	730
Tow line length	[m]	40m (adjustable)

The existing layout in the database was updated with drawing 2015-568-00, which was delivered by the client. Visuals were updated with help of drawing PLN-GE-00000-0002-revB-option 2-sht1. The ENC of the area, used in the ECDIS during the simulations, was also updated with the above mentioned information. Two buoys and mooring dolphins on the south side of the Mississippihaven were removed and the most easterly buoy was placed 200m to the east.

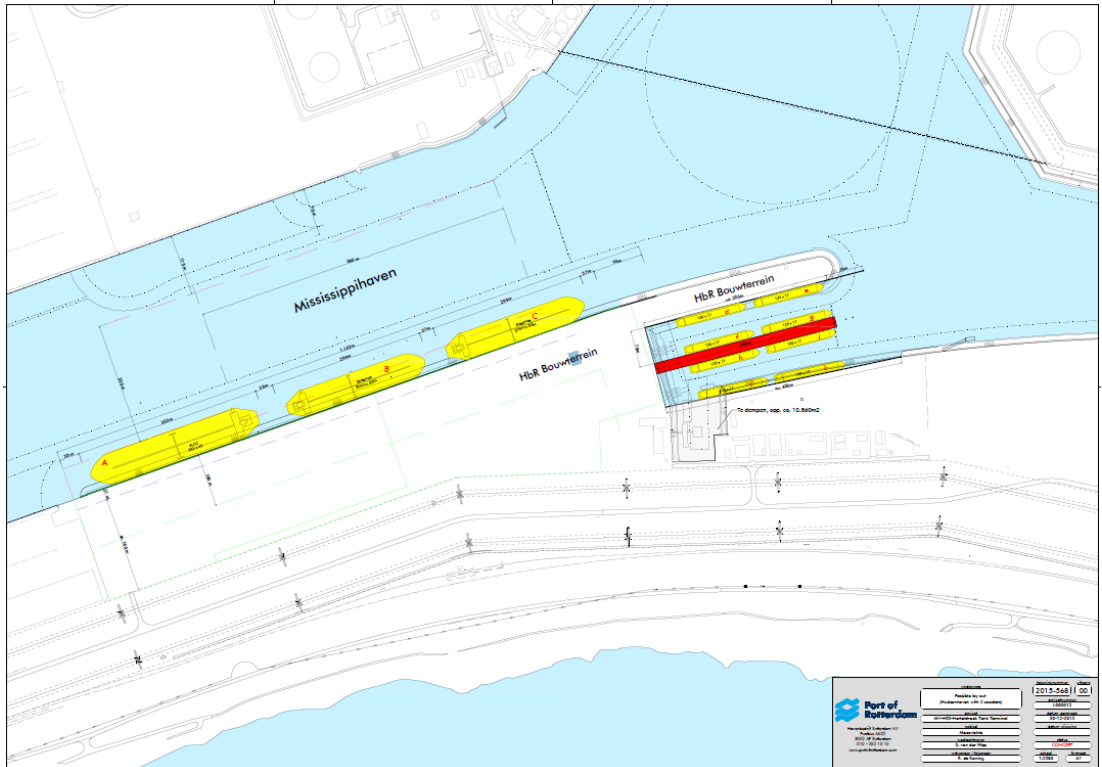

Drawing 2015-568-00, Mississippihaven liquid bulk terminal

The water depths implemented in the Mississippihaven area are taken from the ENC, updated with the design depth as delivered by the client (see drawing below). In the simulator database the water depth in the basin was adjusted to NAP-24.0m. The depth at the terminal where the Suezmax tankers are moored to NAP-19.0m. For the VLCC a pocket was created with a depth of NAP-24.0m.

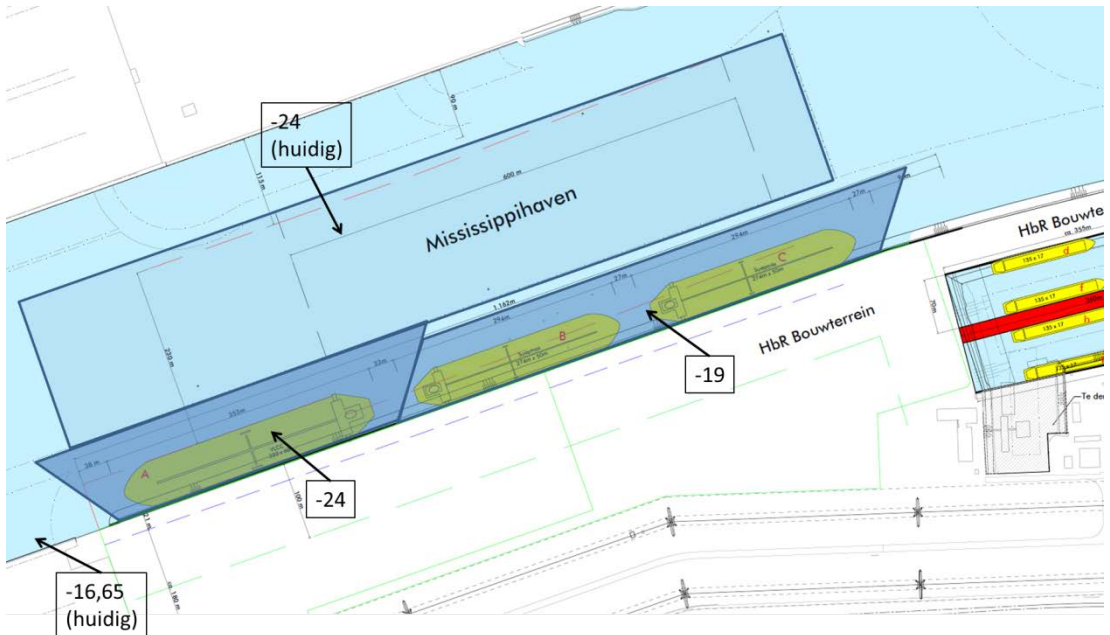

Implemented water depth in the Mississippihaven (depths in NAP)

The moored vessels were placed as shown in the figure below. Also the location of the buoys in front of the new terminal as amended for this study are shown.

- | | |
|--------------------------|-------------|
| 1. Feeder | 160 x 25m |
| 2. Inland vessel | 110 x 11.4m |
| 3. Floating crane | 50 x 36m |
| 4. Panamax bulkcarrier | 225 x 32m |
| 5. Bunker vessel | 135 x 22m |
| 6. Vale Max bulk carrier | 362 x 65m |
| 7. Capesize bulk carrier | 290 x 45m |
| 8. VLCC tanker | 333 x 58m |
| 9. Suezmax tanker | 274 x 50m |

The total width of the bulkcarrier, floating crane and bunker vessel is 90m.



Locations of moored ships and aids to navigation

For these simulations current data delivered by Port of Rotterdam for a previous study in 2014 was included. The data consisted of a 10 layer current grid.

Especially, the modelling of stratified flow was of importance for this study, since the area in which the turn into the Mississippihaven is made is under influence of a salt water tidal driven current and a fresh water river outflow from the Hartelkanaal. The effects of the stratified flow are fully incorporated in the manoeuvring models of the used vessels.

A complete tidal cycle (12 hours) was implemented, with the time of HW Hoek van Holland at 12.00. This made it possible to start the simulations at any tidal stage and simulate any flood or ebb current velocity with the corresponding tidal level.

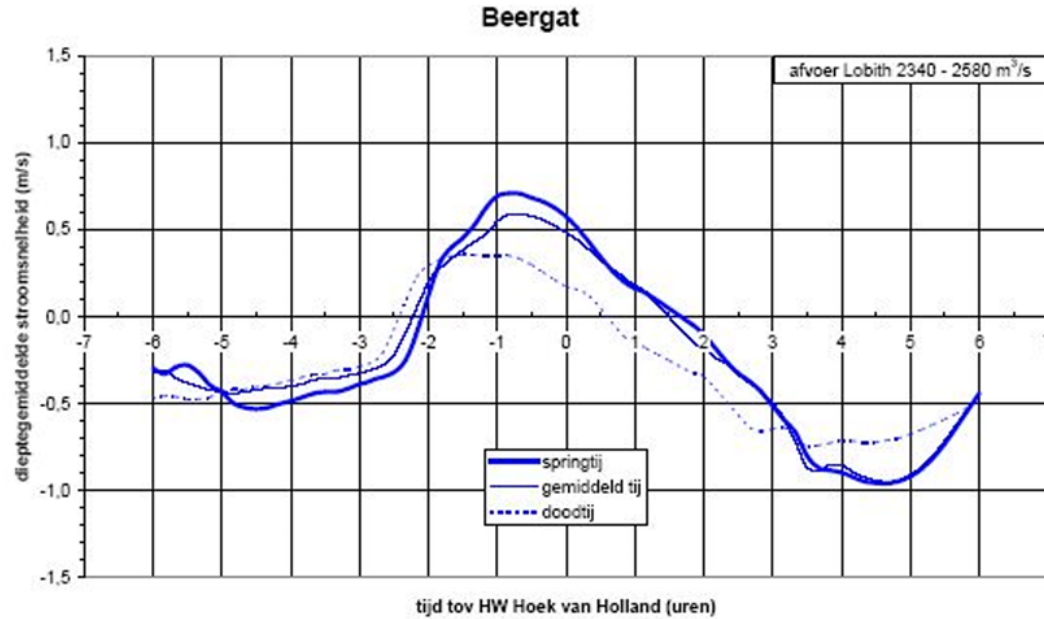

Depth average current in Beergat relative to HW Hoek van Holland

The figure above was used to determine the desired current situation. Together with the pilots the start times of the simulations were determined to create a specific current situation. In the table below, the start time of the simulator run for each current situation and the expected time at the turning circle in front of the Mississippihaven is given.

Current situation and corresponding simulator times.

Current situation	Start time	Time at turning circle
Ebb 1 kts	07.15 / 14.45	07.30/15.00
Flood 1 kts	10.20 / 11.50	10.35/12.05
Slack of LW	09.30	09.45
Slack of HW	13.15	13.30
Max ebb	16.00	16.15
Max flood	10.50	11.05

The wind fields have been delivered by the Port of Rotterdam Authority. The wind patterns were calculated with Computational Fluid Dynamics (CFD) and delivered in ASCII files for three wind directions: SSW, W and NW. The delivered wind fields are relative to a 10 m/s wind measured at Noorderhoofd at 10m height. To create a wind force 7 wind field, all values were multiplied by a factor 1.55. This delivers a 15.5 m/s wind, which is roughly the middle value of the wind force seven band. Beaufort 7 is the wind limit, determined in the previous study [1], under which vessels can safely navigate the Beerkanaal. The wind fields included shielding by objects. The simulator also accounts for wind shielding by moored vessels.

Results of the simulations

The following run program was executed:

Run overview

Run	Scenario	Ship	Wind [m/s]	Current
16-1	Arrival	Capesize 292x45x18.5	SSW 10	Ebb
16-3	Arrival	Capesize 292x45x18.5	SSW 15.5	Ebb 1 kts
16-4	Arrival	Capesize 292x45x18.5	NW 15.5	Flood 1 kts
16-5	Arrival	Capesize 292x45x18.5	NW 15.5	Flood 1 kts
16-6	Arrival	VLCC 332x58x21.0	SSW 15.5	Flood 1 kts
16-7	Arrival	VLCC 332x58x21.	NW 15.5	Flood max
16-8	Arrival	Valemax 362x65x22.6	W 15.5	Flood max
16-9	Arrival	Valemax 362x65x22.6	SSW 15.5	Flood max
17-10	Departure	Valemax 362x65x14.0	NW 15.5	Slack HW
17-11	Arrival with turn	Valemax 362x65x22.6	SSW 15.5	Slack LW
17-12	Arrival with turn	Capesize 292x45x18.5	SSW 15.5	Slack LW
17-13	Arrival	Capesize 292x45x18.5	NW 15.5	Flood max
17-14	Arrival	Valemax 362x65x22.6	SSW 15.5	Slack HW
17-15	Arrival	Capesize 292x45x18.5	SSW 15.5	Ebb max
17-16	Arrival	Capesize 292x45x18.5	NW 15.5	Ebb max
17-17	Departure	Valemax 362x65x14.0	SSW 15.5	Slack HW
17-18	Departure	Valemax 362x65x14.0	SSW 15.5	Slack HW
18-19	Arrival	Capesize 292x45x18.5	NW 15.5	Ebb max
18-20	Arrival	Capesize 292x45x18.5	SSW 15.5	Ebb max
18-21	Arrival	Valemax 362x65x22.6	NW 15.5	Flood Max
18-22	Arrival	Valemax 362x65x22.6	SSW 15.5	Flood Max
18-23	Arrival	Capesize 292x45x18.5	SSW 15.5	Ebb Max f1.3
18-24	Departure	Valemax 362x65x14.0	W 15.5	Slack HW
18-25	Arrival	Capesize 292x45x18.5	NW 15.5	Ebb Max f1.3
18-26	Arrival	VLCC 332x58x21.0	W 15.5	Ebb Max f1.3

The runs were evaluated by the simulator instructor and the pilots. A numerical analysis was performed as well. In the standard MARIN methodology the analysis of the simulations focuses on two elements:

- The used space, in particular the minimum distances towards dangerous points;
- The controllability of the vessel.

In the following table the recommended safety margin is given for the design ships used in this study in relation to the vessels moored at the north and south side of the Mississippihaven.

Safety margins for different situations

	Vale Max loaded				VLCC loaded				Capesize bulk carrier loaded			
Ws0	74m				67m				55m			
Wind direction	NW & W		SSW		NW & W		SSW		NW & W		SSW	
Side of basin	S	N	S	N	S	N	S	N	S	N	S	N
fs1	0.6	0.3	0.3	0.6	0.6	0.3	0.3	0.6	0.6	0.3	0.3	0.6
fs2	0.1	0.1	0.1	0.1	0.1	0.1	0.1	0.1	0.1	0.1	0.1	0.1
fs3	0.0	0.0	0.0	0.0	0.1	0.1	0.1	0.1	0.0	0.0	0.0	0.0
fs4	0.0	0.2	0.0	0.2	0.0	0.2	0.0	0.2	0.2	0.2	0.2	0.2
Safety margin	51.6	44.2	29.5	66.3	53.6	46.9	33.5	66.9	49.9	33.2	33.2	49.9

The controllability of the vessels was evaluated by determining the reserves in tug use and engine/rudder use. The reserves are required to cope with unexpected events and emergency situations. In this study a lot of emergency situations were simulated. In such circumstances it is acceptable that criteria are exceeded as long as the situation is resolved. When and to what extent criteria are exceeded provides insight in the difficult parts of a manoeuvre, and can be studied to optimize the operation. The overall appreciation of a run relied heavily on the opinion of the pilots.

The runs were evaluated in groups of comparable situations. The following distinction was made:

- Arrivals with capesize bulk carrier
- Arrivals with Vale Max bulk carrier
- Departures with Vale Max bulk carrier
- Arrivals with VLCC

Conclusions and recommendations

Based on the evaluation of the simulations the following can be concluded and recommended:

- The safety hazards of the moored vessels close to the turning basin were investigated with real-time simulations in which emergencies were simulated with a Capesize bulk carrier at a draft of 18.5m. The admittance policy and procedures are adequate and the presently used tug configurations provide sufficient reserves to handle emergencies in a controlled manner. Even under extremely adverse conditions and unfavourable timing of emergency events it was possible to stay well clear of the tankers at the new tank terminal.
- The safety hazards were also investigated with a Vale Max and a VLCC in fully loaded condition. Due to their inertia and size these vessels are most difficult to control in an emergency. Grounding on the embankment in front of the tank terminal could not be avoided under all conditions, but this occurred on headings almost parallel to the embankment. With such headings the embankment will not be penetrated in such a way that a collision with the moored tankers is possible.
- The impact of the new terminal on vessels destined for the EMO terminal is minimal. The Vale Max in loaded condition can safely enter the basin, given the maximum mooring configuration on the north and south side of the Mississippihaven.
- The empty Vale Max can safely depart from the EMO terminal with strong winds and with vessels moored at the south side of the Mississippihaven. Swinging in the turning circle was the most difficult part of the manoeuvre and it is advised to execute the turn in the turning circle close to 6th Petroleum terminal.

- The mooring forces of vessels at the new terminal were determined with additional calculations. The mooring forces remain well within the limits.
- The simulations were performed without bunker ships alongside the tankers. The presence of bunker ships would reduce the available width by +/- 20m. When this is translated to the simulation results of the Capesize bulk carriers there is only one case in which this would lead to the distance criterion being exceeded with a few meters. Considering that in the simulation program both the Vale Max and VLCC ended up on the embankment once, and considering that a bunker ship will be very close to the slope, it is not unlikely that these vessels are capable of penetrating the embankment to such an extent that a collision with the bunker ships occurs. Therefore it is recommended not to allow bunker ships alongside the most easterly tanker during the arrival of a Vale Max or VLCC.
- The position of the tanker berths is well chosen. Shifting them more to the east will bring them too close to the path of a vessel that takes a wide swing (due to e.g. a black-out). It may also increase the hindrance to inland vessels that turn in- and out of the Hartelkanaal.
- In the study performed in 2008 [1], conclusions were drafted for a layout with a navigable width of 258 m. Formally the new berths would need to be moved 12m land inward to comply with this width. The present study shows that this extra width is not required, especially if there is no bunkering on the most eastern tanker berth during arrival of Vale Max/VLCCs.
- When the same tidal regime, currently in force for the EMO terminal, is applied to the new terminal, the chance exists that regularly multiple ships need to enter during the same tidal window (flood). This may lead to conjunction and delays.
- It is advised to optimize tug configurations for emergency situations instead of berthing convenience. When the bow tug is fastened on the shoulder it can be used for braking as well, increasing the braking capacity with 25%. The drawback is that for the final berthing manoeuvre it has to let go and reposition to a pushing position, but this is hardly a problem. Wind and current conditions within the basin are generally benign and have little effect on the loaded vessels.
- Keep speed low when arriving with the Vale Max/VLCCs in loaded condition. Before starting the turn, the speed should be below three knots, which means that reducing speed starts in an early stage.
- Pilots should be trained to handle black-outs and other emergencies (e.g. tug failures) in this area.

1 INTRODUCTION

A new terminal may be situated at the south side of the Mississippihaven at Maasvlakte 1. At this terminal liquid bulk will be transferred for which a petroleum regime has to be implemented. The limiting conditions at which ships can safely navigate the Beerkanaal have been determined previously but the new terminal and the associated petroleum regime may introduce additional limitations. Real-time manoeuvring simulations were performed to study the nautical consequences.

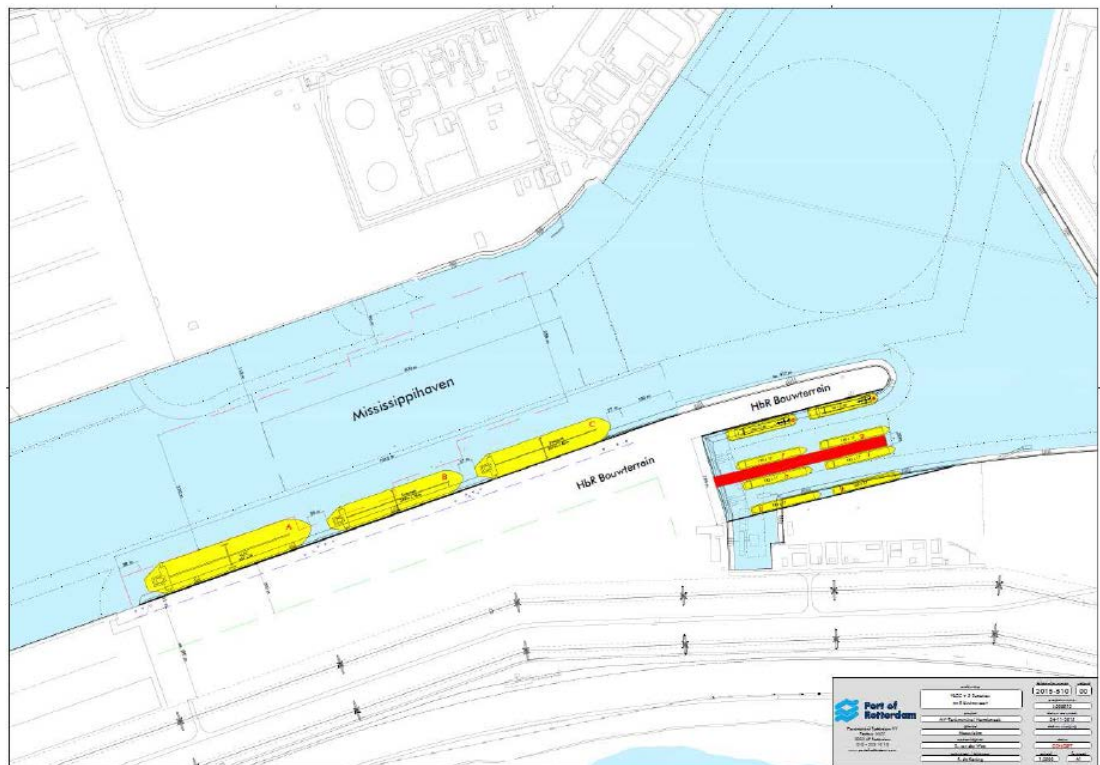

Figure 1-1 Mississippihaven liquid bulk terminal

Figure 1-1 shows the new terminal at the south side of the Mississippihaven. VLCCs and Suezmax vessels would moor at this terminal, from where the liquid bulk is transferred to inland vessels and coasters. It is anticipated that a vessel moored at the east side of the terminal is most vulnerable to other vessels that enter the Mississippihaven and for some reason are not able to make the manoeuvre. At the north side of the Mississippihaven a dry bulk terminal (EMO) is situated where very large bulk carriers berth.

In 2008 MARIN conducted full-mission simulations for both bulk carriers and container vessels: 'Effecten van toekomstige ontwikkelingen op de nautische toegankelijkheid van de Mississippihaven' [1]. In which the following questions were answered:

- Under which conditions (current and wind) can the manoeuvres for the design vessels with destination EMO and Beerdam terminals be executed safely?
- Under which conditions is it possible to accommodate two way traffic in the Mississippihaven between the design vessels assisted by tugs and an inland vessel or container feeder?

Now this study has been updated to identify the safety hazards for the moored vessels close to the turning basin and to determine the impact of the new terminal on the EMO terminal.

The Port of Rotterdam Authority ordered MARIN to perform this study and real-time simulations were carried out in February 2016. This report describes the execution and analyses of the results of this study. The report is divided into the following sections:

- Section 2: Objective of the study and approach;
- Section 3: Simulator database and ship models;
- Section 4: Real-time simulations;
- Section 5: Conclusions and recommendations.

2 OBJECTIVES OF THE STUDY AND APPROACH

2.1 Objectives of the study

The objective of the study is a further assessment of the nautical accessibility of the Mississippihaven. It should complement and update the study executed in 2008 [1].

The following items are to be studied:

- Investigate the safety hazards of the moored vessels close to the turning basin (with respect to the petroleum regime to be implemented) and give suggestions for possible additional measures to lower the risks involved. This will be done by:
 - simulating an inbound vessel that has a black-out
 - simulating an inbound vessel with a failing stern tug
- Compared to the study mentioned in [1], the ships moored at the south side of the Mississippihaven have shifted 12 m to the north. Determine the impact of the new terminal on vessels destined for the EMO terminal:
 - given the maximum mooring configuration at the north and south side of the Mississippihaven and the horizontal tide limits that are currently in force, can a loaded Vale Max ship safely enter the Mississippihaven? If not make suggestions to minimum available fairway width and/or the limiting conditions.
 - can an empty Vale Max vessel safely departure from the EMO terminal with strong winds from NNW direction and with vessels moored at the south side of the Mississippihaven?
 - determine the mooring forces of vessels moored at the new terminal when VLOC pass.

2.2 Approach and methodology

The study was started with a kick-off meeting with representatives of the Port of Rotterdam Authority and one of the pilots involved in this study. In this meeting MARIN presented the project approach. The setup and input parameters and scenarios were discussed and agreed upon.

With this input and the data delivered by the client the simulator database was setup (see chapter 3). This setup was tested and approved on the validation day. The comments were rectified.

A three day simulator session was used to address the objectives of the study. During the simulations regular debriefings were held to capture the results and to discuss the program in order to achieve the objectives of the study. On completion the simulations were analysed and evaluated. The results and conclusions are discussed in this report.

3 SIMULATOR DATABASE AND SHIP MODELS

3.1 Introduction

This chapter describes the database of the area and the mathematical manoeuvring models used for the simulations. The database is an updated version of the standard database used by the Dutch Pilots. For this update the results of the 3D flow calculations and 3D wind model as delivered by the Port of Rotterdam were used. Besides this the Port of Rotterdam delivered the new layout with depth data and locations of the moored ships. The river outflow of the Hartelkanaal causes significant differences between the flow in the upper and lower layers in the area concerned.

3.2 Dolphin

The simulations were executed with MARIN's newly developed bridge simulator software 'Dolphin'. The MARIN *DOLPHIN simulation technology* is designed for interactive simulations of many types of nautical operations.

For engineering purposes MARIN is using its in-house developed mathematical framework called XMF¹. It consists of modules for various physical phenomena and it sits at the heart of MARIN's time domain simulation software. Hence, DOLPHIN contains this XMF calculation kernel and apart from that, it contains a 3D visualisation and various windows-based user interfaces to control and monitor the simulation in progress.

Due to its open and scalable architecture it can be used for *Full-mission Bridges* or smaller simulator setups all the way to its most compact form on a *single laptop*. DOLPHIN can be applied in real-time simulations with operators in the loop, but also for easy preparation of scenarios and engineering purposes.

DOLPHIN consists of three main layers:

- Full 6 DOF hydrodynamic engine (XMF based calculation kernel)
- Flexible middle layer (HLA, High Level Architecture)
- Main components of the outer layer:
 - Visualisation
 - Instructor Operator Station (IOS)
 - Console & controls

The IOS is a Windows based intuitive, user friendly interface. Principally, it consists of a 2D area view that uses genuine ENC's and an ECDIS-kernel and a set of control GUIs for monitoring and controlling the simulation. This modular setup gives the instructor the ability to obtain an immediate situational awareness and allows for modifying essential elements such as wind, wave and current fields as well as the weather in a straightforward manner.

MARIN's real-time simulation technology follows DNV's guidelines on simulators being used for training purposes, be it company specific or in accordance with IMO STCW training. Any of the parameters, such as line forces, speed, UKC or otherwise, can be put into a time graph for better monitoring over a longer period. This can be done during run-time and serves for debriefing purposes as well.

¹ XMF: eXtensible Modeling Framework (MARIN's time domain calculation kernel)

Coupled to the live simulations is a modular technology for visualisation in 3D. The number of visual channels depends on the definition of the simulator. Typically, the IOS will also have one 3D visual channel (Stealth system) to enable fly through the scene as the scenario progresses.

The fact that MARIN implemented its time domain calculation kernel XMF in the DOLPHIN simulation technology means that the calculations conducted with our engineering time domain code are also valid for the simulator since that part of the code is the same.

A good example of this is for instance that the same potential flow theory calculations used in RAPID are implemented in the DOLPHIN simulator in a dynamic way. Hydrodynamic effects in the DOLPHIN simulations that are highly determined by this are:

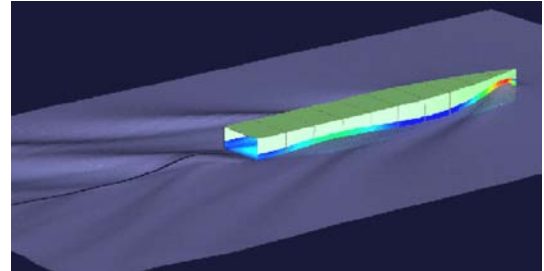

- Ship-ship interaction, both in deep and in shallow water
- Ship-bottom interaction
- Ship-bank interaction
- Cushioning effects

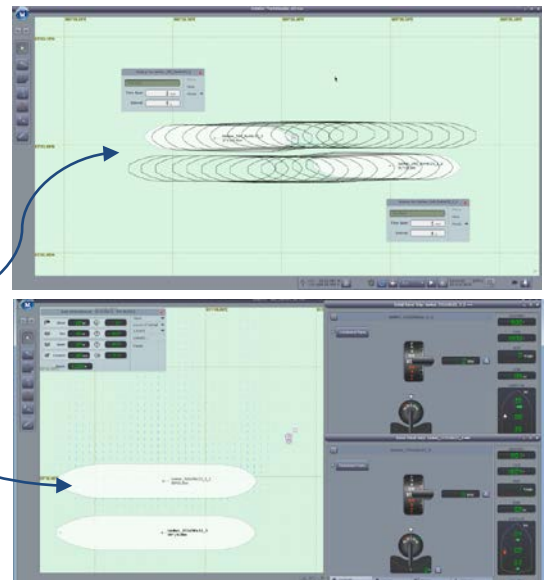

3.2.1 Layouts, visuals and depth contours

The existing layout in the database was updated with the drawings delivered by the client. In Figure 3-1, drawing 2015-568-00 is shown, which shows the modifications to the layout. In Figure 3-2 the resulting layout in the simulator is presented. The ENC of the area, used in the ECDIS during the simulations, was also updated with the above mentioned information. Two buoys and mooring dolphins on the south side of the Mississippihaven were removed and the most easterly buoy was placed 200m to the east.

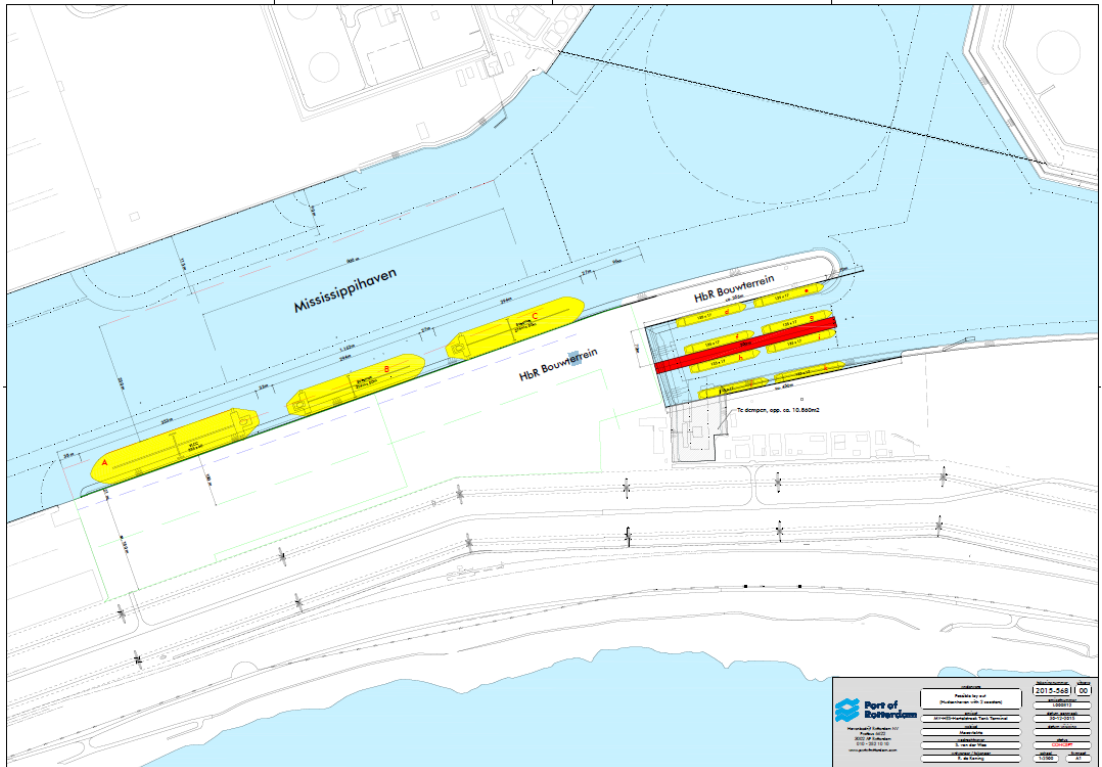

Figure 3-1 Drawing 2015-568-00, layout to be tested

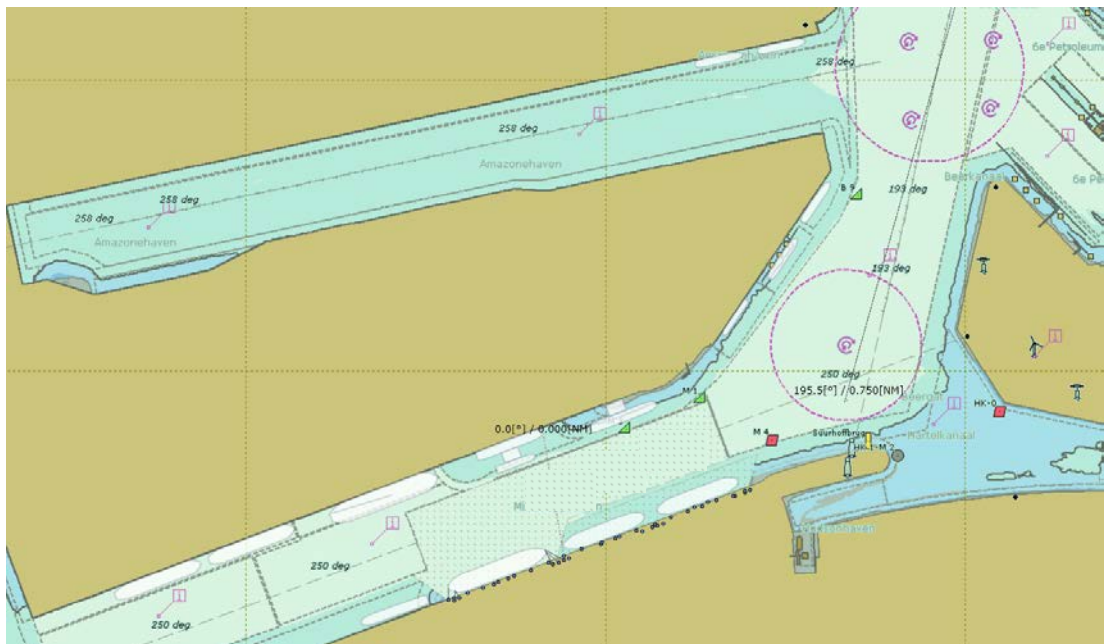

Figure 3-2 Layout as implemented in the simulator

The water depths implemented in the Mississippihaven area are taken from the ENC, updated with the design depth as delivered by the client (see Figure 3-3). In the simulator database the water depth in the basin was adjusted to NAP-24.0m. The depth at the terminal where the Suezmax tankers are moored to NAP-19.0m. For the VLCC a pocket was created with a depth of NAP-24.0m.

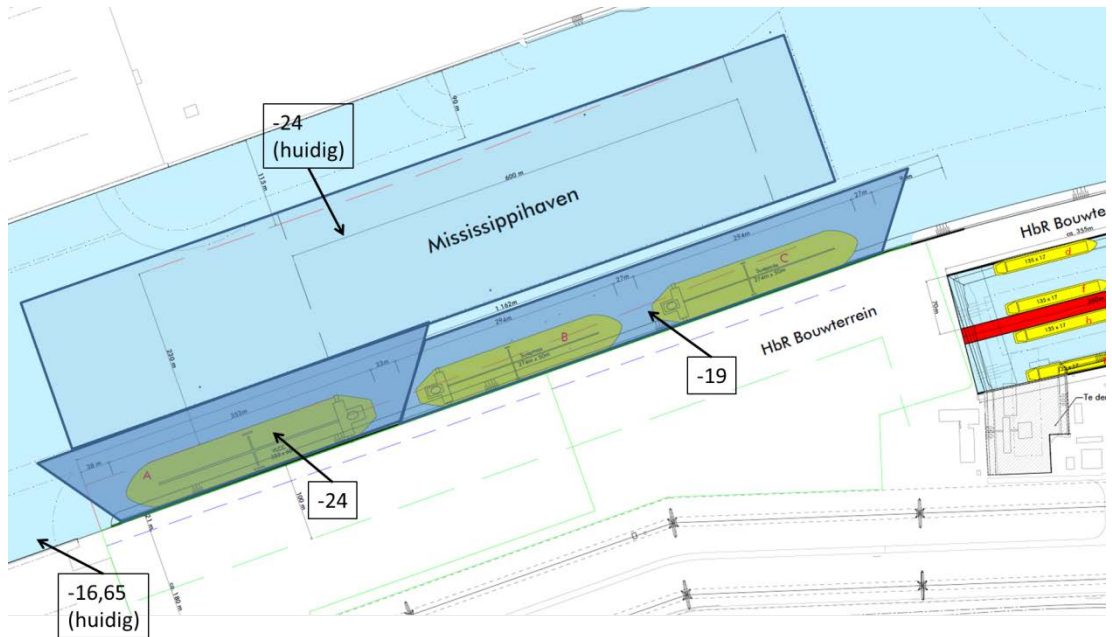

Figure 3-3 *Implemented water depth in the Mississippihaven (depths in NAP)*

Visuals were updated with help of drawing PLN-GE-00000-0002-revB-option 2-sht1, which was delivered by the client. An impression of the visuals is given below.



Figure 3-4 *Impression of the visual database*

3.2.2 Moored ships

To meet the objective of the study the simulations were executed with the maximum mooring configuration at the north and south side of the Mississippihaven as described by the client. The moored vessels were placed as shown in Figure 3-5.

- | | |
|--------------------------|-------------|
| 1. Feeder | 160 x 25m |
| 2. Inland vessel | 110 x 11.4m |
| 3. Floating crane | 50 x 36m |
| 4. Panamax bulkcarrier | 225 x 32m |
| 5. Bunker vessel | 135 x 22m |
| 6. Vale Max bulk carrier | 362 x 65m |
| 7. Capesize bulk carrier | 290 x 45m |
| 8. VLCC tanker | 333 x 58m |
| 9. Suezmax tanker | 274 x 50m |

The total width of the bulkcarrier, floating crane and bunker vessel is 90m.

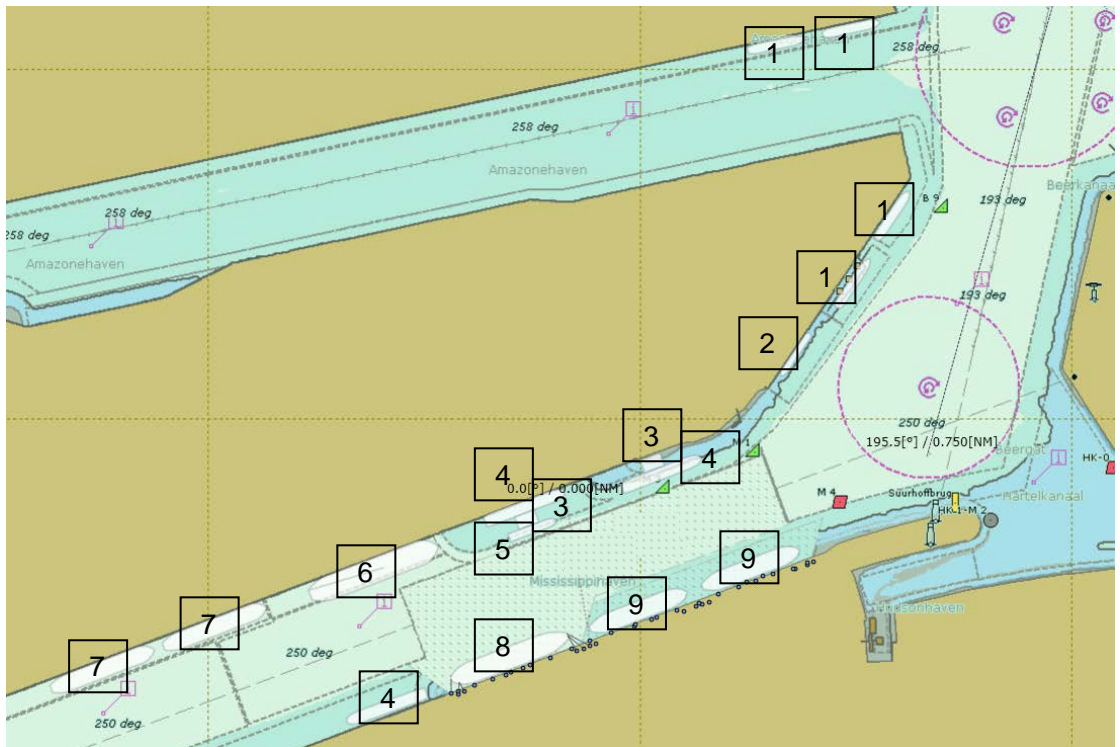

Figure 3-5 Locations of moored ships

3.2.3 Current patterns

For these simulations current data delivered by Port of Rotterdam for a previous study in 2014 was included. The data consisted of a 10 layer current grid. Figure 3-7 shows an example of the current velocity and direction at a point in the Beergat at layer 1 (top layer) and at layer 10 (layer at the bottom). A complete tidal cycle (12 hours) was implemented, with the time of HW Hoek van Holland at 12.00. This made it possible to start the simulations at any tidal stage and simulate any flood or ebb current velocity with the corresponding tidal level. Figure 3-6 was used to determine the desired current situation. Together with the pilots the start times of the simulations were determined to create a specific current situation. In Table 3-1 for each current situation the start time of the simulator run and the expected time at the turning circle in front of the Mississippihaven is given.

Table 3-1 Current situation and corresponding simulator times.

Current situation	Start time	Time at turning circle
Ebb 1 kts	07.15 / 14.45	07.30/15.00
Flood 1 kts	10.20 / 11.50	10.35/12.05
Slack of LW	09.30	09.45
Slack of HW	13.15	13.30
Max ebb	16.00	16.15
Max flood	10.50	11.05

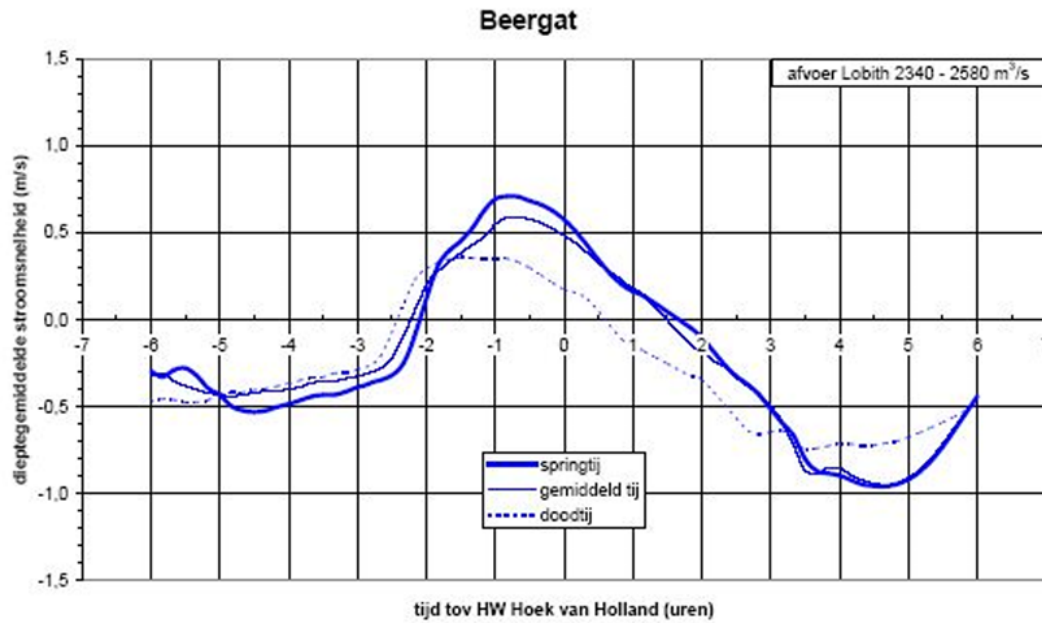

Figure 3-6 Depth average current in Beergat relative to HW Hoek van Holland

Below the tidal curve as implemented in the simulator and current speeds and directions in different layers are plotted. It is clear that the current in layers differ considerably from the average current as plotted in Figure 3-6.

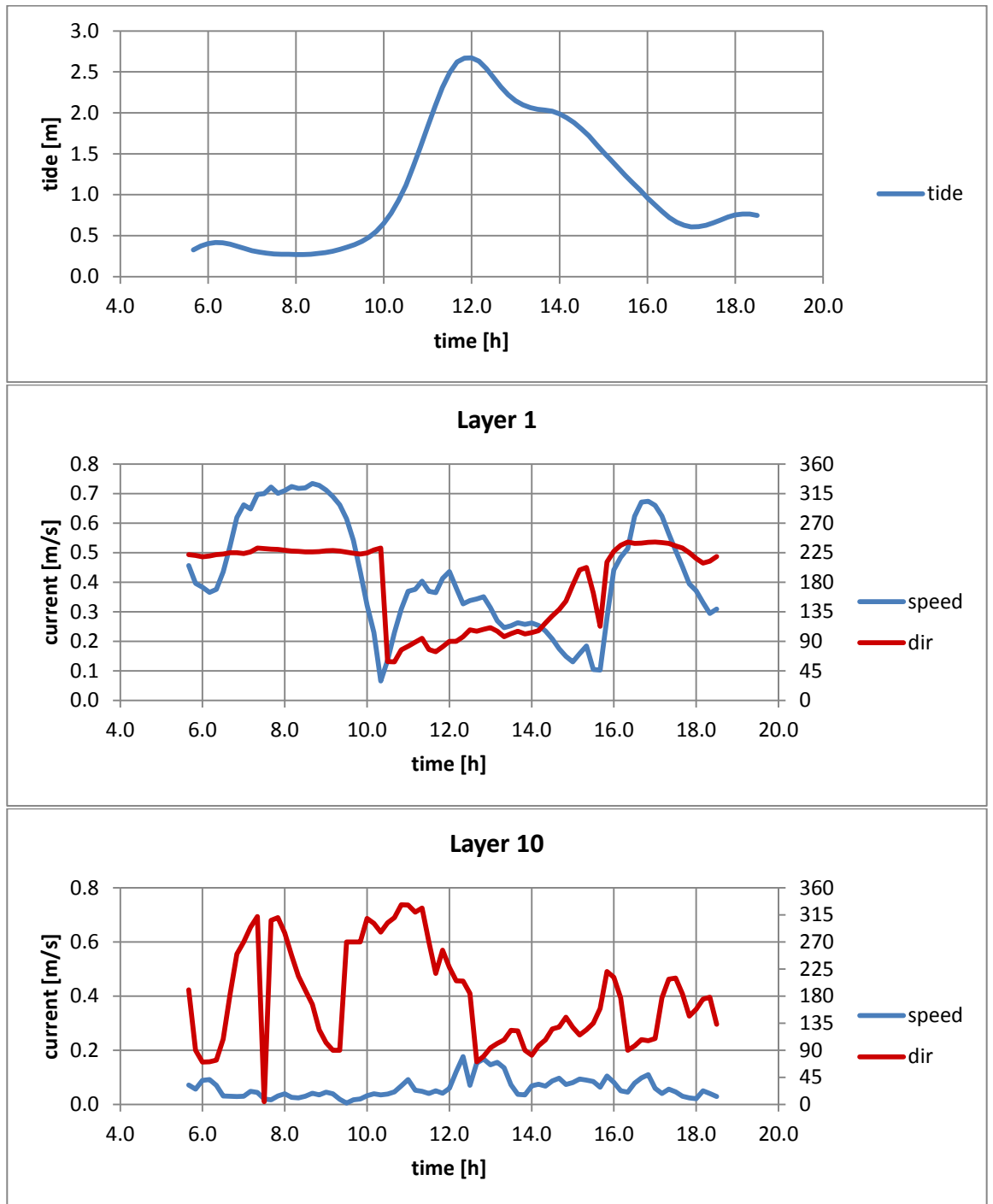

Figure 3-7 Tidal curve and current info in Beergat at layer 1 and 10

Plots of the most relevant current situations are given below. These are the maximum flood, maximum ebb and slack of high water situations for the time that the vessel is in the turning circle. The simulator plots the upper layer only. A comparison between the simulator current and the input data from the client for the relevant current patterns are given.

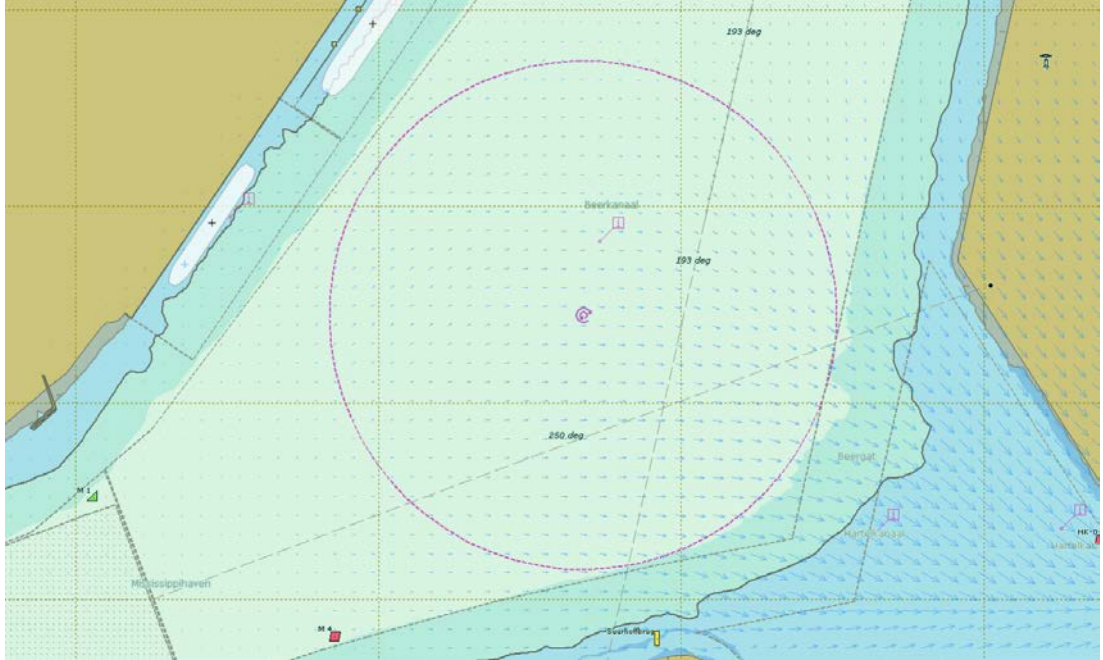

Figure 3-8 Current pattern maximum flood (layer 1) in simulator, $T=11.05$

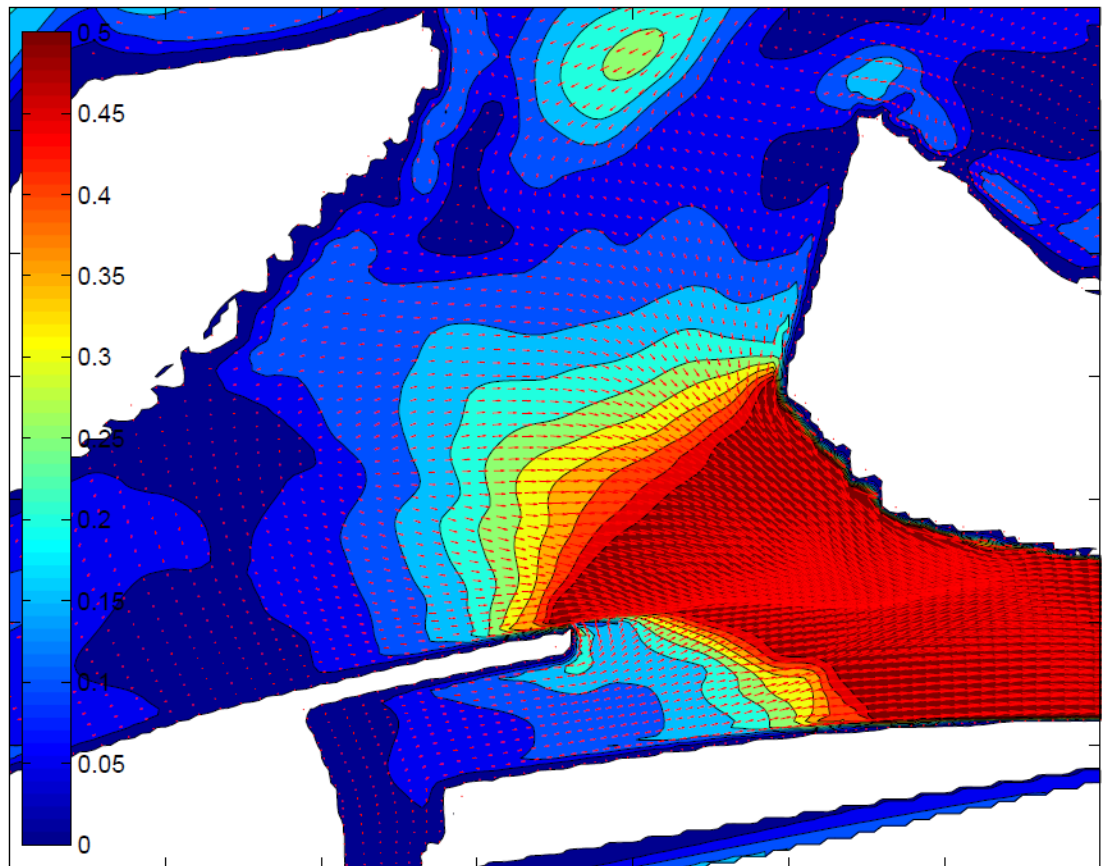

Figure 3-9 Current pattern maximum flood (layer 1), input data

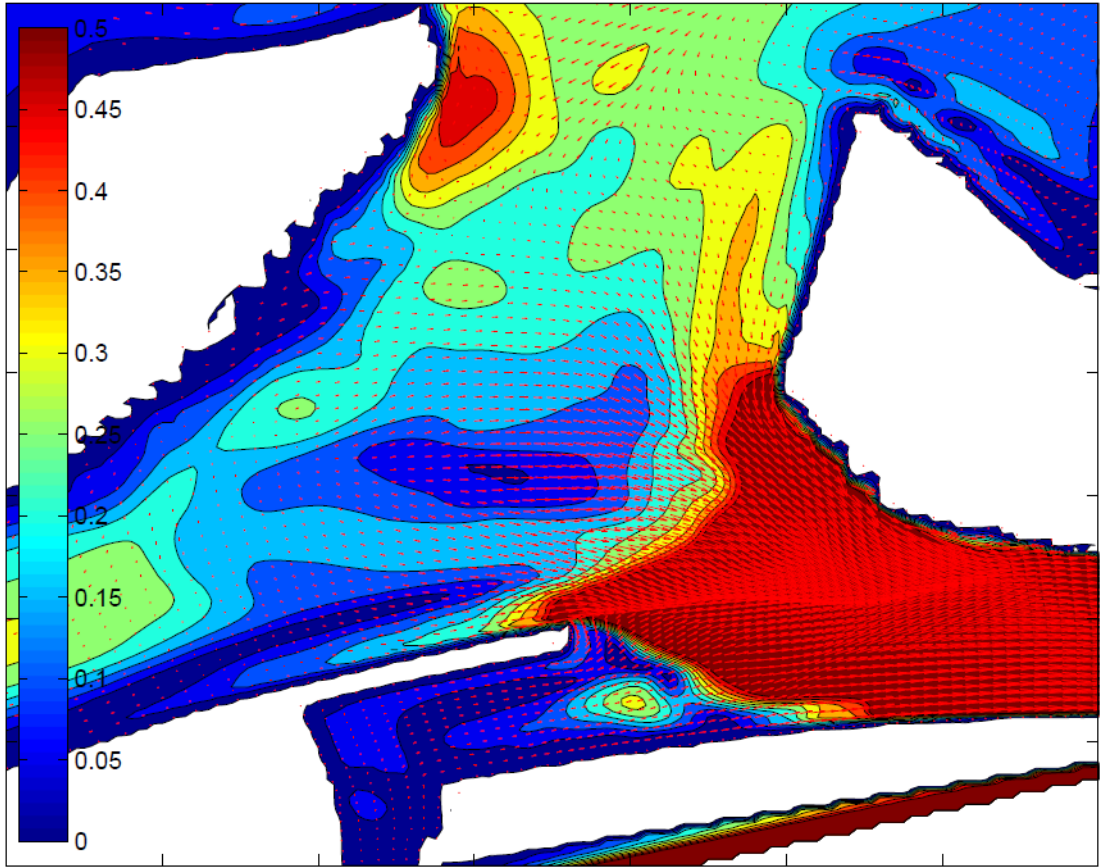

Figure 3-10 Current pattern maximum flood (layer 5), input data

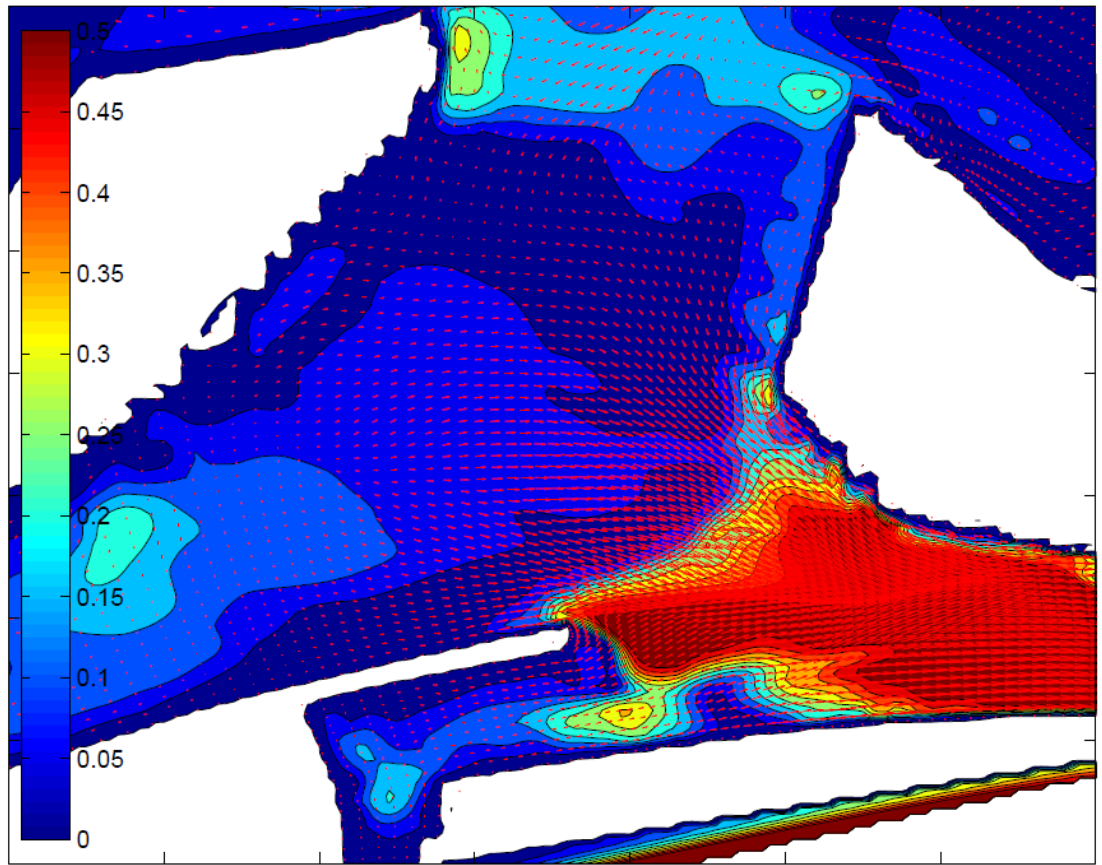

Figure 3-11 Current pattern maximum flood (layer 10), input data

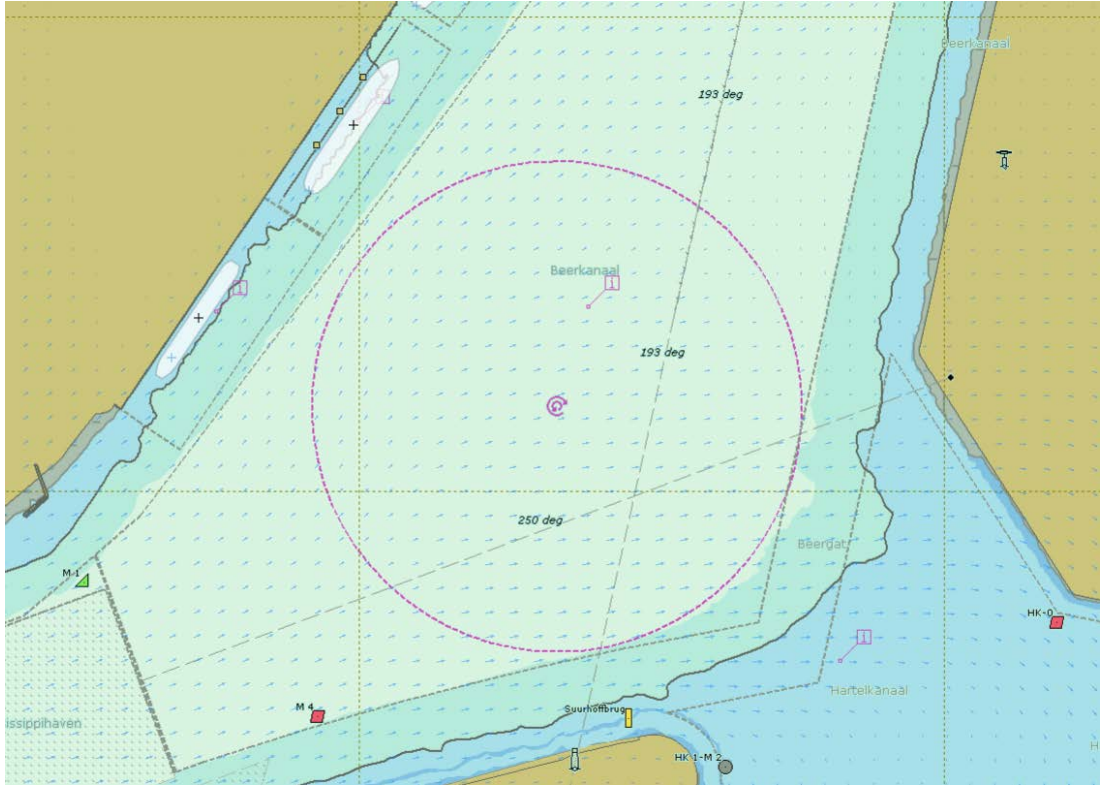

Figure 3-12 Current pattern slack of HW (layer 1) in simulator, T=1330

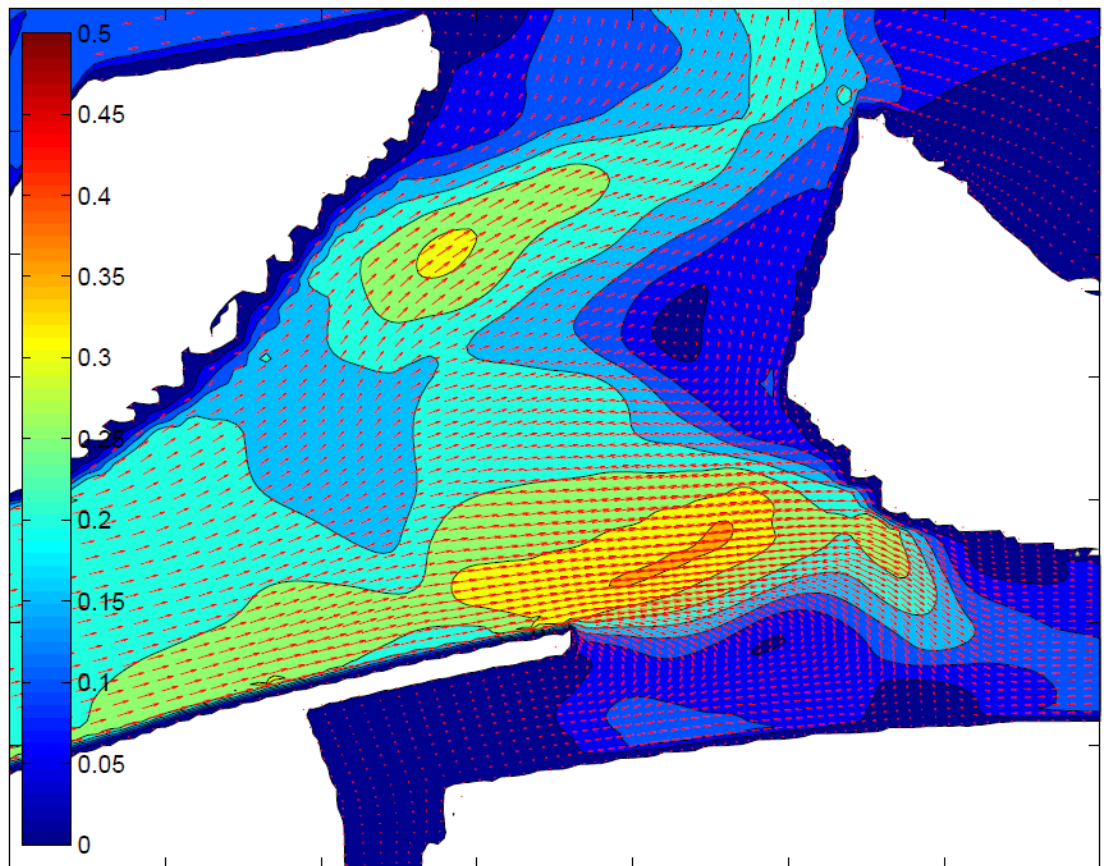

Figure 3-13 Current pattern slack of HW (layer 1), input data

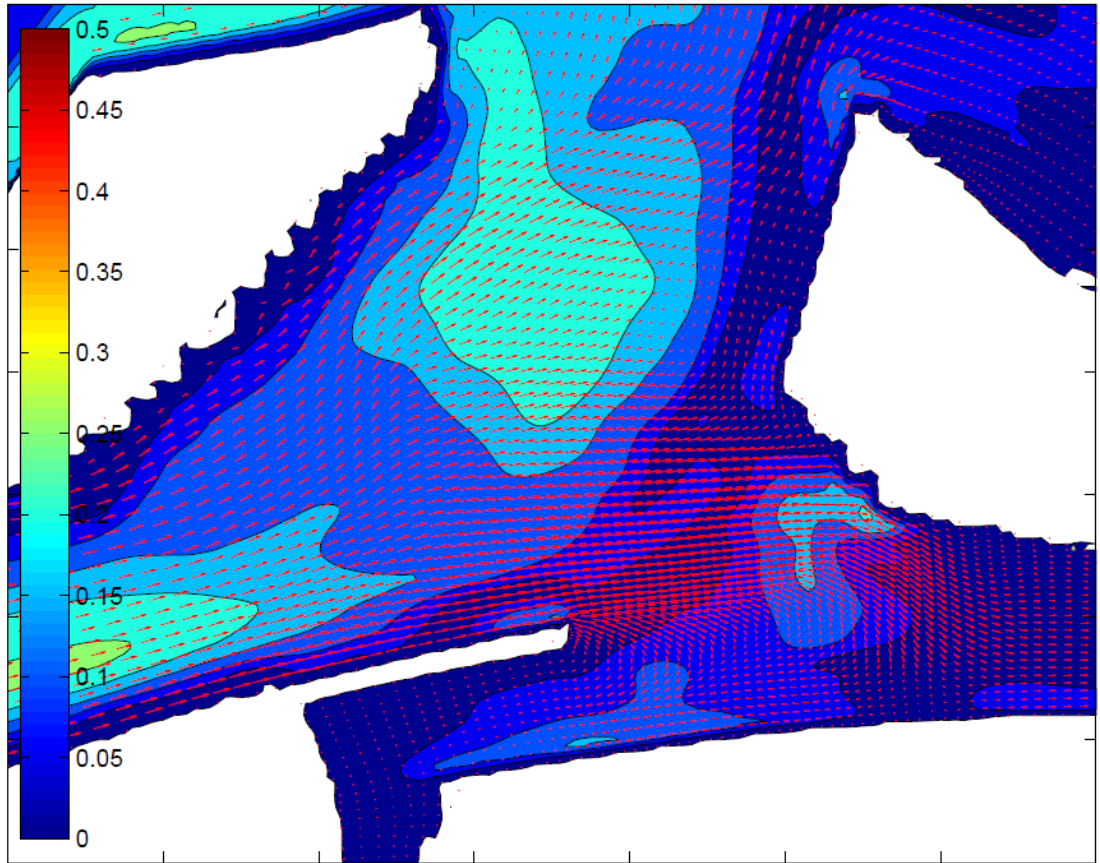

Figure 3-14 Current pattern slack of HW (layer 5), input data

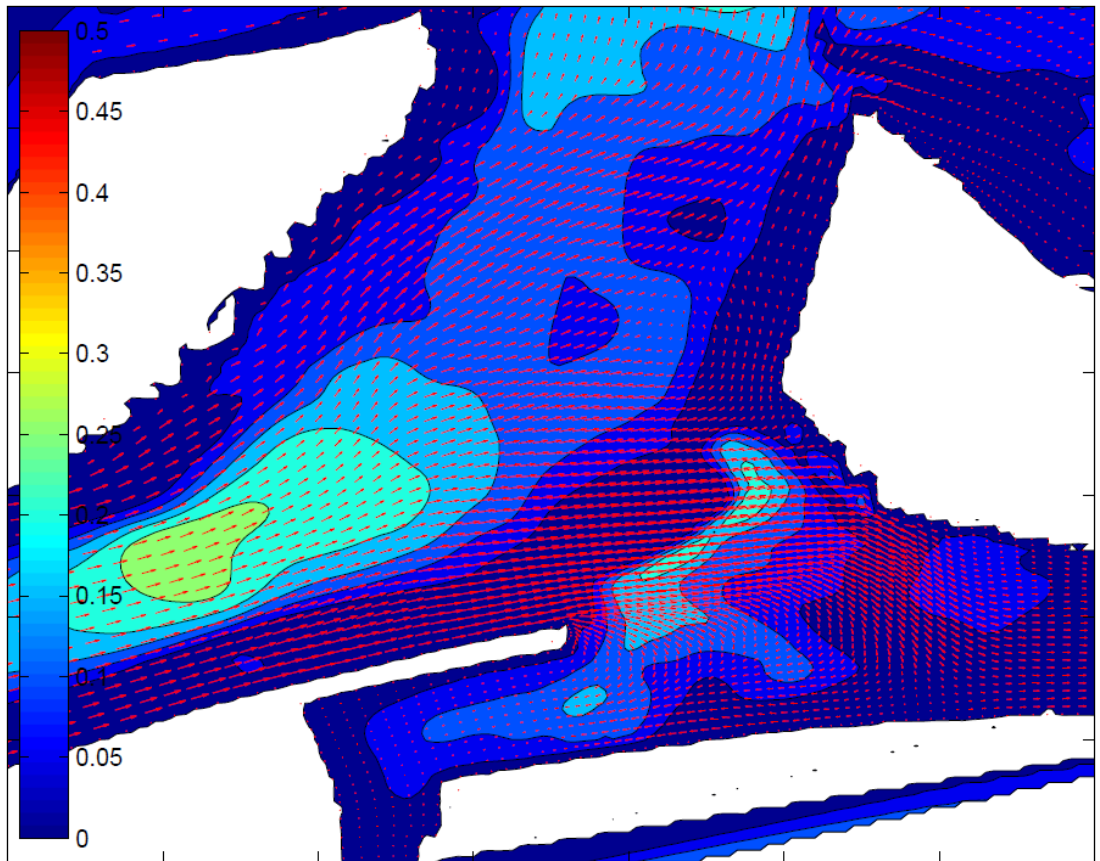

Figure 3-15 Current pattern slack of HW (layer 10), input data

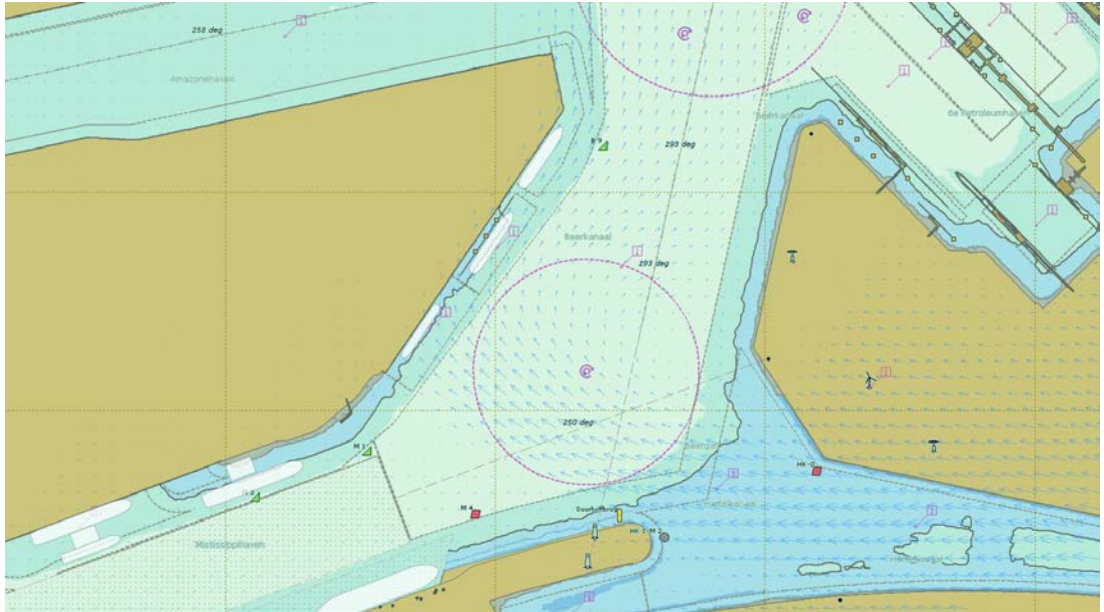

Figure 3-16 Current pattern maximum ebb (layer 1) in simulator, T=16.15

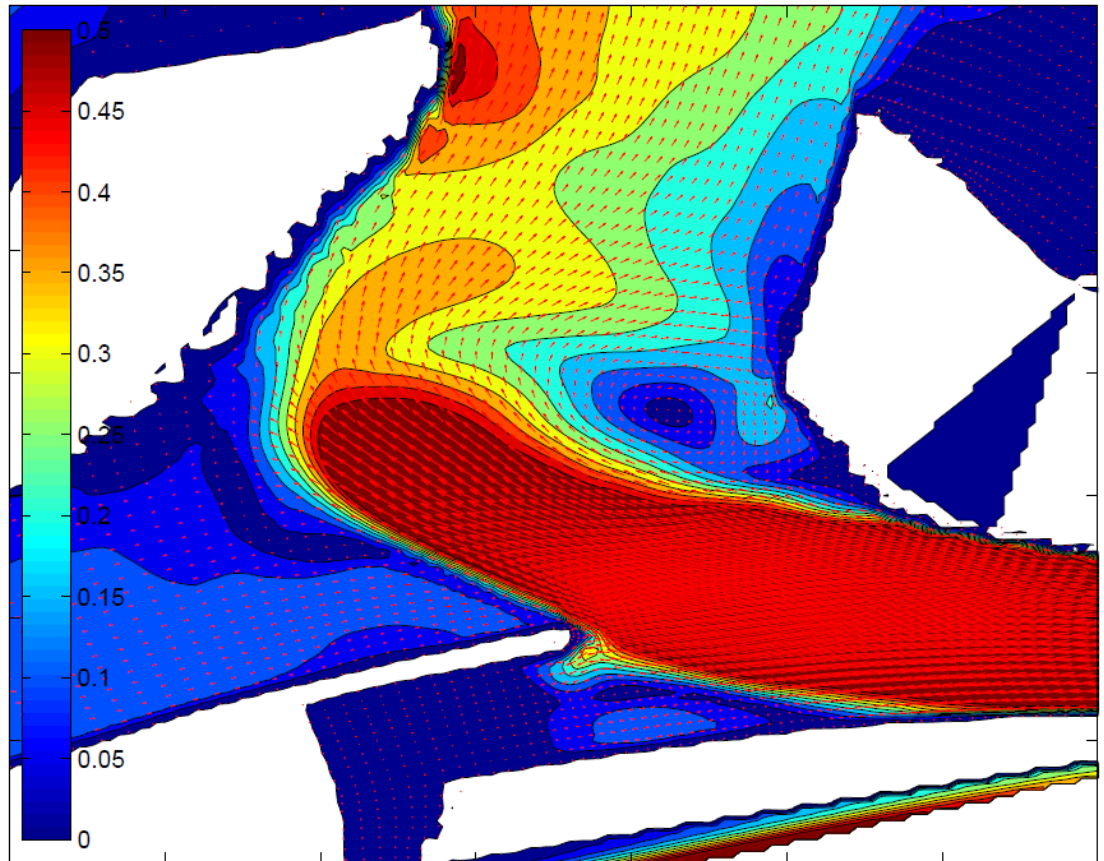

Figure 3-17 Current pattern maximum ebb (layer 1), input data

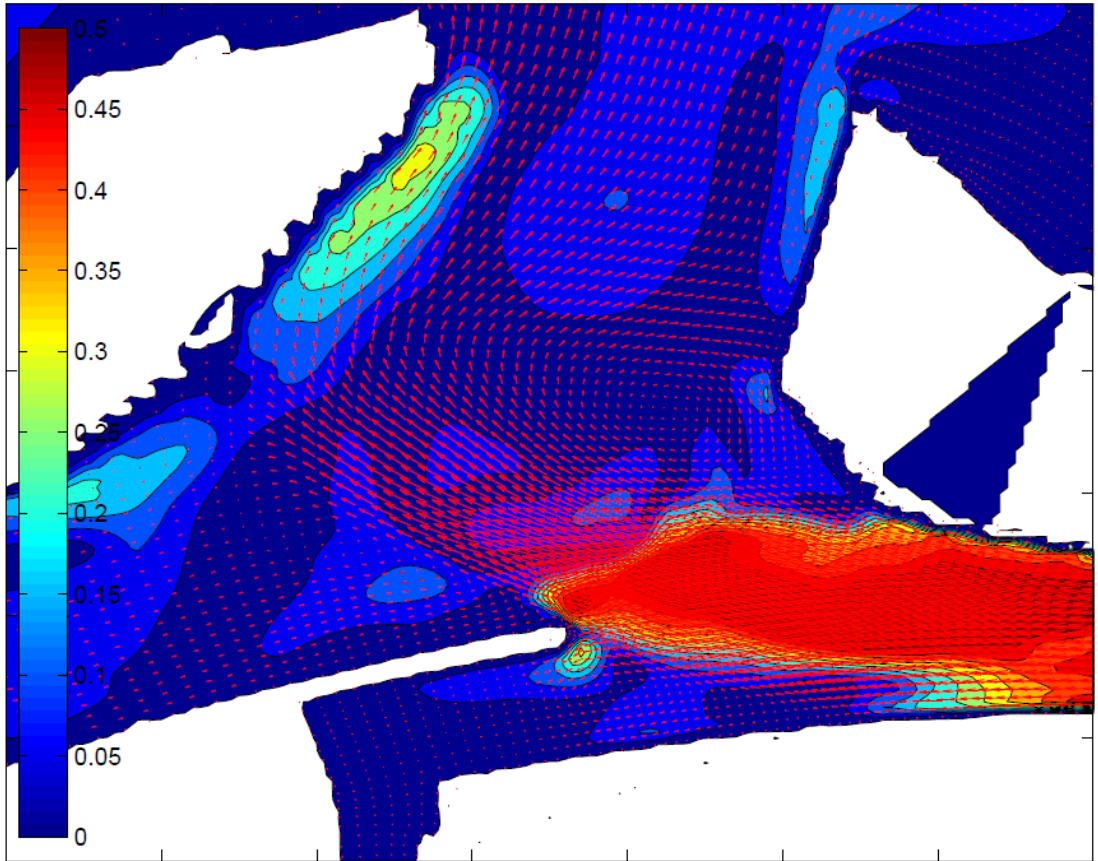

Figure 3-18 Current pattern maximum ebb (layer 5), input data

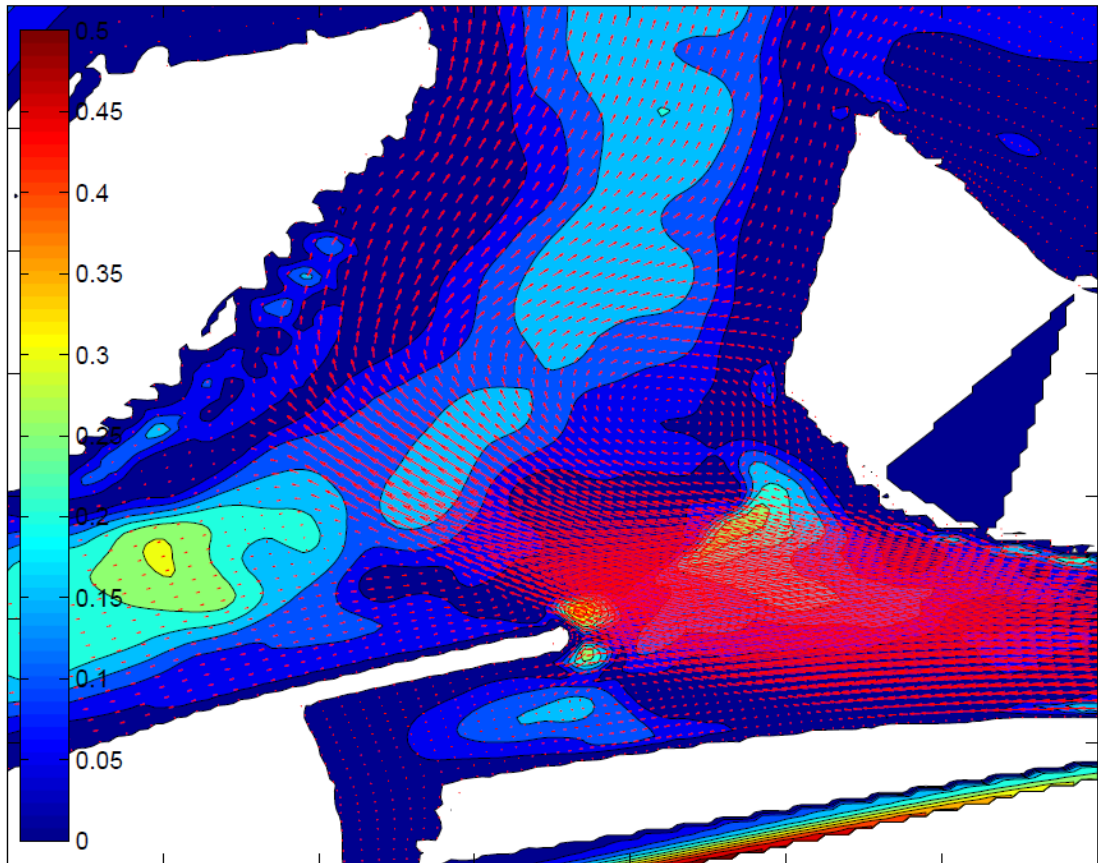

Figure 3-19 Current pattern maximum ebb (layer 10), input data

3.2.4 Wind fields

The wind fields have been delivered by the Port of Rotterdam Authority. The wind patterns were calculated with Computational Fluid Dynamics (CFD) and delivered in ASCII files for three wind directions: SSW, W and NW. The next plots show the plots as they were delivered and implemented in the simulator. The delivered wind fields are relative to a 10 m/s wind measured at Noorderhoofd at 10m height. To create a wind force 7 wind field, all values are multiplied by a factor 1.55. This delivers a 15.5 m/s wind, which is roughly the middle value of the wind force seven band.

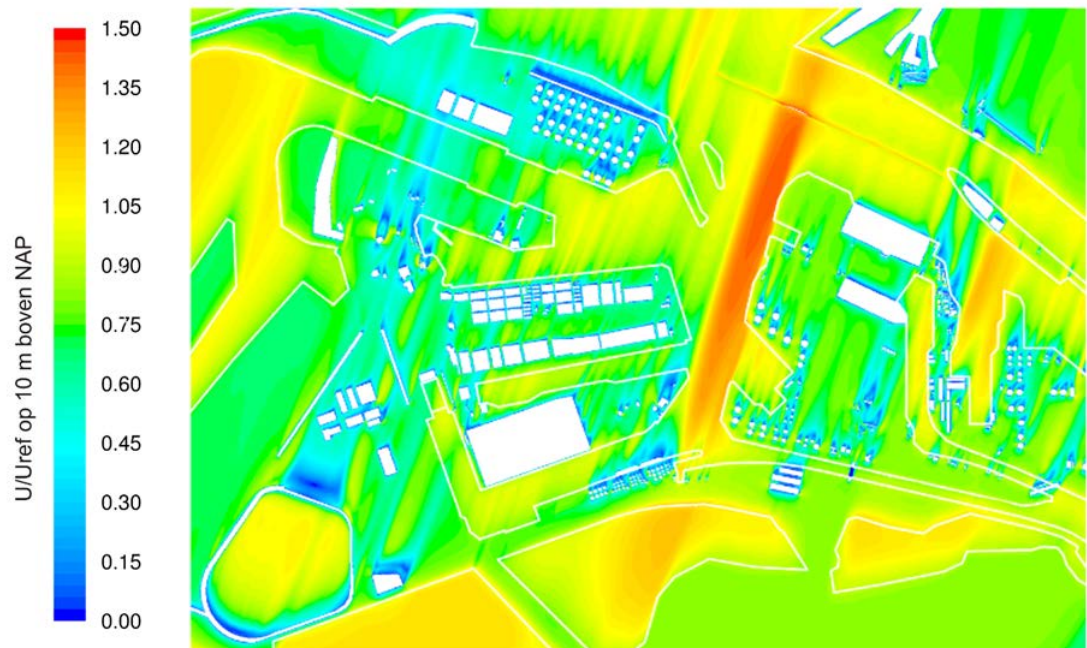

Figure 3-20 Results of CFD calculations with wind from SSW (200°)

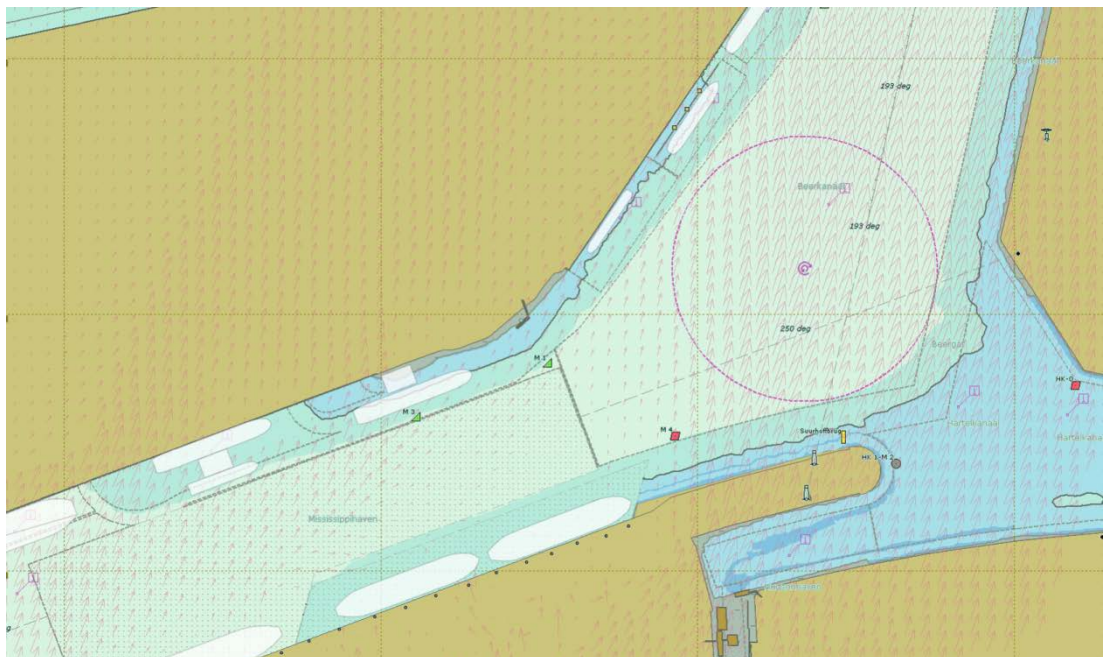

Figure 3-21 Wind field in simulator, SSW (200°)

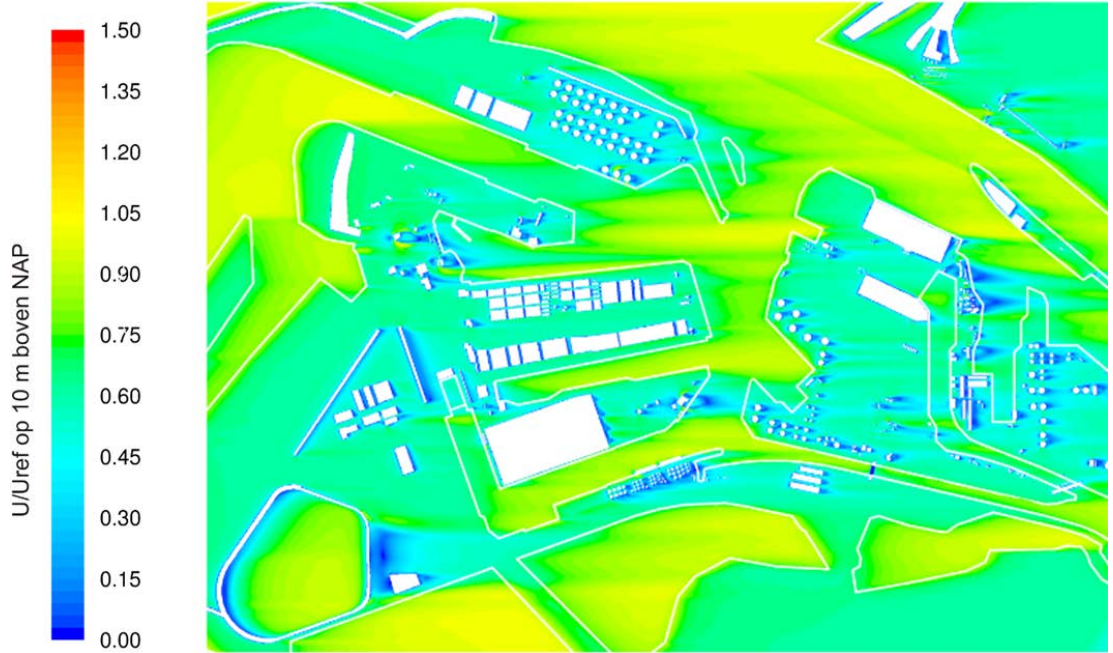

Figure 3-22 Results of CFD calculations with wind from W (270°)

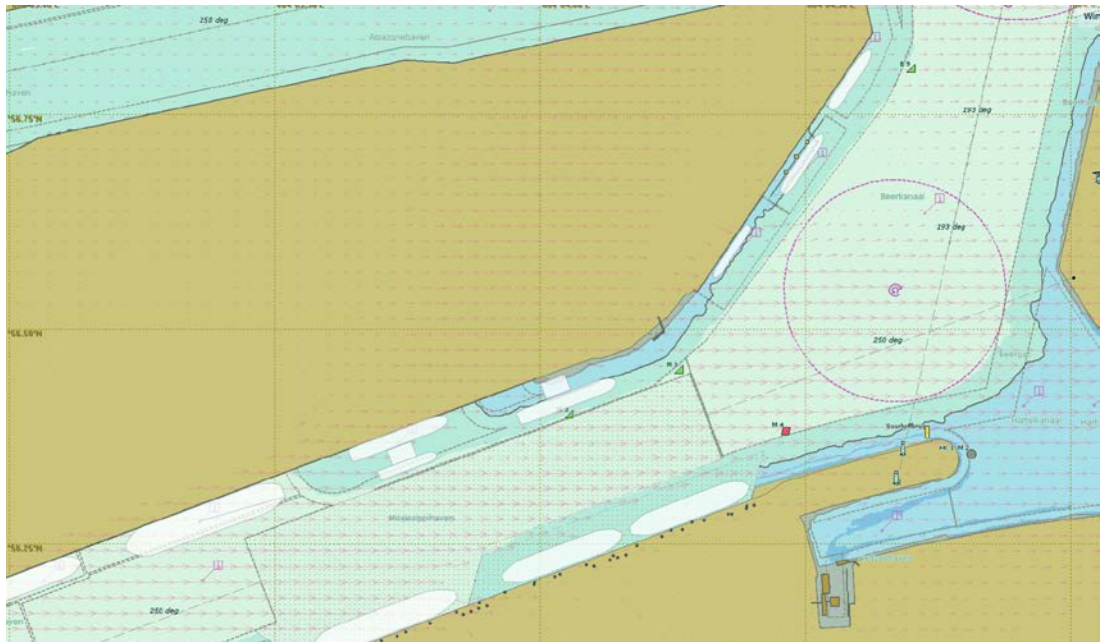

Figure 3-23 Wind field in simulator, W (270°)

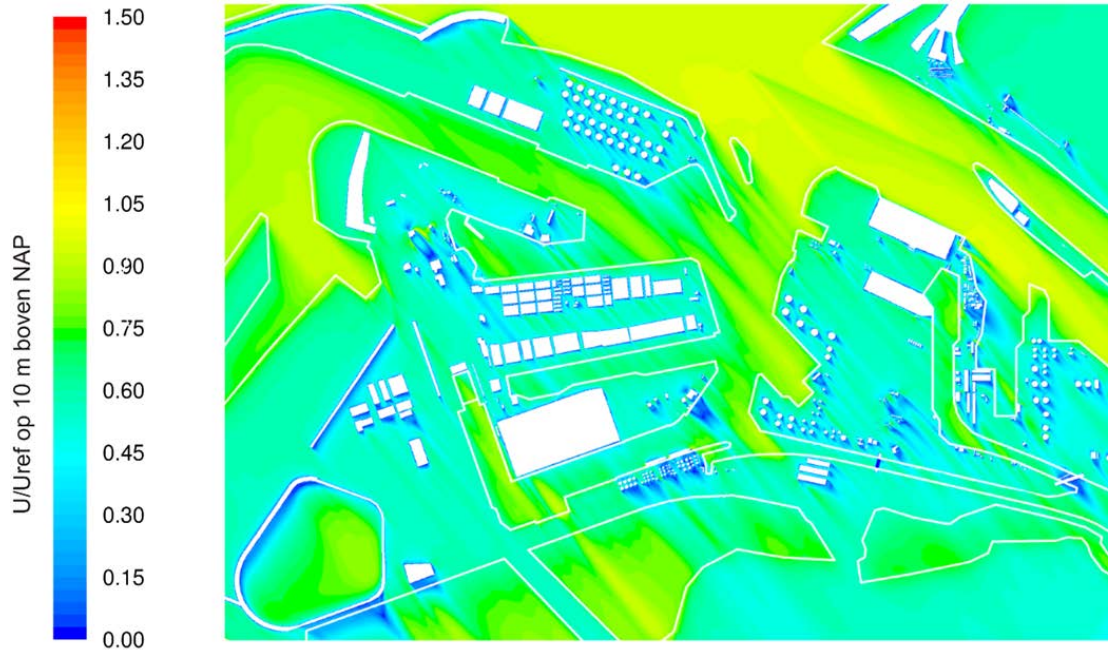

Figure 3-24 Results of CFD calculations with wind from NW (320°)

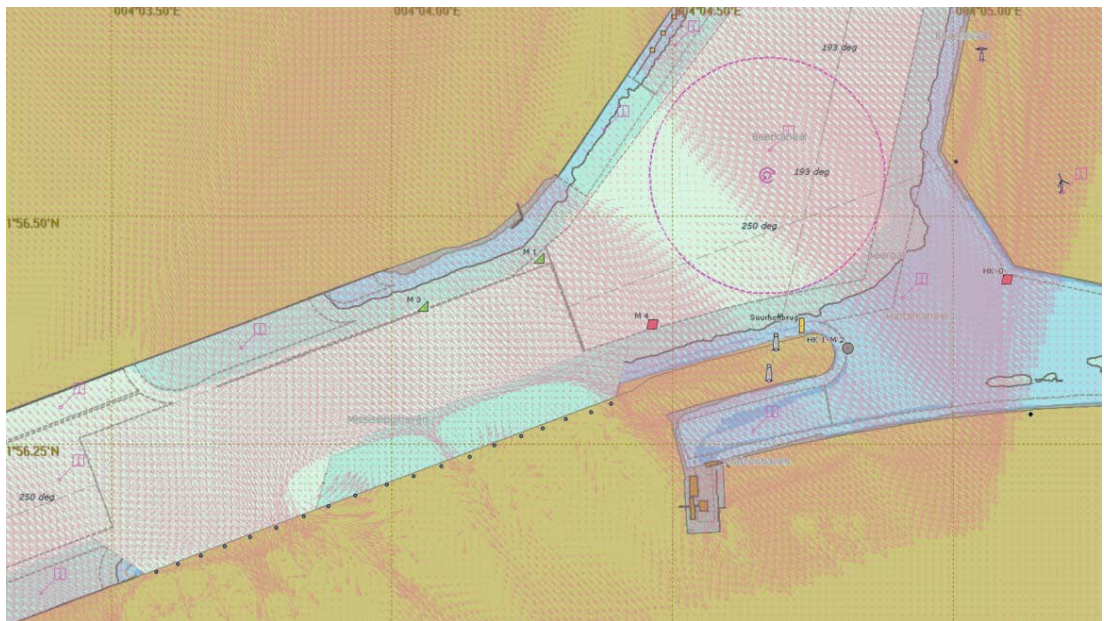

Figure 3-25 Wind field in simulator, NW (320°)

Apart from the built-in shielding in the CFD model, wind shielding by ships is incorporated in the simulator. A vessel downstream of a large structure or another vessel will experience less wind when it comes closer to such an obstacle. Furthermore, wind gusting is included. A Davenport spectrum is used for this purpose.

3.2.5 Wave fields

Wave fields have been estimated presuming that only locally wind induced waves are present at this location. The maximum wave height is about 0.5 m for the Bft 7 wind condition. The waves only affect the assisting tugs, which do not sail close to the sheltered areas near the upwind quays. Therefore the wave height and direction are kept constant over the whole area and only depend on wind direction and velocity.

3.2.6 Modelling aspects of vessels

To model the correct hydrodynamical effects, such as multi layer current effects and ship/ship and ship/bank interaction a number of features have been modelled for the various vessels. To reduce calculation times not all vessel contain all features. Table 3-2 shows the features modelled in the sailing vessels, the free sailing tug and the moored vessels.

Table 3-2 Modelling aspects of vessels

Bridge controlled ships							
	Ship	Wave actions	Multi layer current	Flow Interaction	Wind shielding	Propeller jet cone	Fender forces
1A	Vale Max loaded 362x65x22.55	Off	On	On	On	On	Off
1B	Vale Max ballast 362x65x14	Off	On	On	On	On	Off
2	VLCC 333x60x21.0	Off	On	On	On	On	Off
3	Capesize 292x45x18.5	Off	On	On	On	On	Off
Tugs							
1	Damen 3211	On	Off	On	On	On	Off
Moored ships							
1	Vale Max loaded 362x65x22.55	Off	Off	On	On	Off	Off
2	VLCC 333x60x21.0	Off	Off	On	On	Off	On
3	Suezmax 275x50x16	Off	Off	On	Off	Off	On
4	Feeder 160x25	Off	Off	Off	On	Off	Off
5	Feeder 160x25	Off	Off	Off	On	Off	Off
6	Inland vessel 135 x 17m	Off	Off	Off	On	Off	Off
7	Bulkcarrier 290x45	Off	Off	On	On	Off	Off
8	Bulkcarrier 225x32	Off	Off	On	On	Off	Off
9	Floating crane ...x36	Off	Off	Off	On	Off	Off
10	Bunkerlichter 135x22	Off	Off	On	On	Off	Off

Mathematical models have been developed for four different vessels and the tugs. The mathematical models describe amongst others the following effects:

- Manoeuvring properties in deep and shallow water;
- Effects of currents incl. current gradients and stratified flow;
- Effect of Underkeel Clearance on manoeuvring characteristics;
- Squat;
- Wind forces including effects of wind gradients;
- Wind gusting;
- First order wave-induced motions;
- Mean wave drift forces and first order wave-induced motions are computed with DIFFRAC or PRECAL, these models also take into account shallow water effects;
- Propeller wash;
- Interaction forces with other vessels and banks;
- Line forces from tugs assisting the vessel and from the fenders and mooring lines.

Especially, the modelling of stratified flow is of importance for this study, since the area in which the turn into the Mississippihaven is made is under influence of a salt water tidal driven current and a fresh water river outflow from the Hartelkanaal. The effects of the stratified flow are processed in the following way: The manoeuvring model first determines which current layers are applicable, given the draft of the vessel. Then it will

calculate the current velocities and directions along the hull experienced in each of the layers. During each time step the current velocities and directions along the hull are used to calculate the relative water motions in each layer. The manoeuvring forces for each layer separately are calculated based on these relative water motions. Adding up the manoeuvring forces over the draught of the vessel results in the total manoeuvring forces and moments. However, as it is clear that not all layers will distribute equally to the manoeuvring forces (the top layers will be dominant over the layers more downward) a (under keel clearance dependant) weight factor is applied to the forces on each layer of the vessel. The weight factors were determined with the results of CFD calculations with a vessel with high block coefficient in deep and shallow water. During the validation day and the study the pilots confirmed that the current behaved as expected.

Table 3-3 and Table 3-4 show the main dimensions of the design vessels and the tugs used in this study.

Table 3-3 Properties of the design vessels of this study

Property	unit	Vale Max	VLCC	Capesize bulk carrier
Length o.a.	[m]	362	332	292
Beam	[m]	65.0	58.0	45.0
Draught	[m]	22.55/14.0	21	18.5
Propeller	[-]	1	1	1
Deadweight	[ton]	400,000	284206	179900
Awx	[m ²]	1607/2160	1287	1250
Awy	[m ²]	4497/7549	3491	3189



Figure 3-26 A visual model of the VLCC

The pilot cards of the laden vessels are given in Appendix B. This is the information pilots normally use to prepare the voyage. For this study three or four (for Vale Max and VLCC) ASD tugs with 60 tons BP are modelled. One of the tugs is a free sailing tug steered by an experienced tug captain on a separate simulator. The other tugs are supervisor controlled tugs, the so-called C-tugs. These tugs are steered by an autopilot. The simulator instructor controls these tugs on direct order of the pilot. The instructor sets settings like pulling mode, direction and force. The autopilot then executes these settings within the limits of the capability diagram of the tug.

Table 3-4 Tug properties

Property	unit	Damen3211
Length o.a.	[m]	32.72
Beam	[m]	11.84
Draught	[m]	4.8
Propeller	[-]	2 ASD
Bollard Pull	[Tons]	60
Displacement	[Tons]	730
Tow line length	[m]	40m (adjustable)

One of the purposes of the simulations was to determine the mooring forces of vessels moored at the new terminal when a Vale Max passes. The original idea was to use a realistic mooring configuration. However, due to extra required computational efforts, this plan had to be adjusted. Although interaction forces were calculated in all runs, only in a limited number of runs the moored vessels were allowed to move under the influence of these forces. In these runs the vessels were moored with a simplified mooring configuration using four lines, instead of the 8 lines used in reality.

4 REAL-TIME SIMULATIONS

4.1 Introduction

The real-time simulations were carried out in a three day simulation session from 16 to 18 February 2016. Prior to the simulations a validation day was carried out. The real-time simulations were carried out on Full-mission Bridge I (FMB I) in combination with a Compact Manoeuvring Simulator (CMS).

FMB I has a 360° visual image and is (apart from the main console) also equipped with consoles at the bridge wing positions (at both starboard and port side), which can be used when manoeuvring close to the berth or when sailing astern. The FMB I was connected to a CMS, also called 'tug simulator' from which the free sailing tug was controlled. The CMS has a 270° visual image and an additional monitor that provides the view astern. In Figure 4-1 a picture of the Full-mission Bridge I is presented.

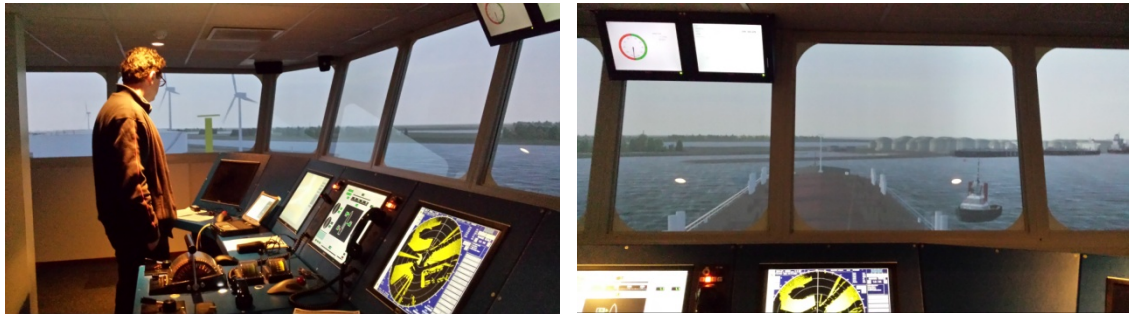

Figure 4-1 View of Full-mission Bridge I

A description of FMB I and the CMS are included in Appendix A.



Figure 4-2 View of tug master steering the stern tug on the tug simulator

The pilots own 'Navigator Marginal Ships' was connected to the simulator. Unfortunately it was not possible to use the modified ENC on this system; therefore an ECDIS with the modified ENC of the area was also available on the bridge.



Figure 4-3 Picture of the pilots 'Navigator Marginal ships'

4.2 Results of the validation day

On Friday February 12th, 2016 a validation day was organised to verify the simulator database. The following items were verified:

- Layout of bridges (consoles, displays, radars and controls);
- Layout of the Mississippihaven as modelled in the simulator;
- ECDIS system;
- Depth field;
- Current patterns;
- Wind pattern for SW wind;
- Visual database;
- Aids to navigation;
- Starting points, speed and tug configuration;
- Manoeuvring properties of vessels and free sailing ASD tug;

Two pilots and a tug captain carried out the validation runs. The testing was observed by a representative of the Port of Rotterdam. Also the simulator instructor and MARIN staff participated in the simulations and discussions. The results of the validation runs were analysed and reported in a memo. Based on the results of the validation runs, the database was adapted or improved where necessary. The results of the validation day are described below:

- The manoeuvring models of VLCC and Capesize bulk carrier were approved by the pilots involved;
- The manoeuvring model of the loaded Vale Max bulk carrier showed a too low Rate of Turn when turning to starboard into the Mississippihaven. This was tested without current as well. The model has been adapted and two test runs with the adapted model showed that the Rate of Turn increased sufficiently;
- The tugs assisting the VLCC at the fore and aft shoulder are shifted to the starboard side;
- Visual model of the Vale Max bulk carrier was adapted to get the correct bridge height;
- Yellow buoys at the north of the basin were removed;
- Visual model may be improved e.g. colouring of Electrabel power station.

The normative current conditions as discussed for the production runs were established. The times mentioned below are the start times of the production runs and the corresponding current situation (related to HW at 12.00 hr, local time).

- 11:00 hr: Maximum flood;
- 9:15 hr and 14:45 hr: Ebb;
- 13:45 hr: Slack water after HW.

4.3 Results of the simulations

From February 16 to February 18 real-time simulations were performed on MARIN's bridge simulators. The simulations were performed by:

- Mr Tom van der Hoff (Dutch Maritime Pilot's Association), pilot
- Mr Jos van de Boel (Dutch Maritime Pilot's Association), pilot
- Mr Robert Blonk (Dutch Maritime Pilot's Association), pilot
- Capt. Leon Versteeg, tug master

Capt. Henk Krutwagen acted as simulator instructor. Mr Dimitri van Heel and Mr Freek Verkerk acted as project manager for MARIN.

The simulations were witnessed by the following persons:

On February 16:

Mr Herm Jan van Wijhe	(Port of Rotterdam Authority)
Mr Cees van der Valk	(Port of Rotterdam Authority)
M(r)s. Wendy Janssen	(Port of Rotterdam Authority)

On February 17:

Mr Joost Leenhouts	(Dutch Maritime Pilot's Association)
Mr Rene De Vries	(Port of Rotterdam Authority)
Mr Ab Kamman	(Port of Rotterdam Authority)

On February 18:

M(r)s. Stefanie van der Wee	(Port of Rotterdam Authority)
Mr Wim Hoebee	(Port of Rotterdam Authority)
Mr Ruud Van Os	(Hess Corporation)
Mr Gerrit Groen	(Hess Corporation)
Mr Jaap van Dalen	(Port of Rotterdam Authority)

A total of 26 simulations were executed, of which one run is qualified as invalid. The simulations are evaluated in two ways. Firstly, the simulations have been analysed numerically. The use of tugs, engine and rudder and the observed passage distances have been determined and compared with objective criteria.

Secondly, the pilots and the simulator instructor have evaluated each run. Pilots and instructor have the experience to judge whether a situation is under control or not. After each run a questionnaire was filled in by the pilots in which they expressed their opinion regarding the safety, use of available space, and controllability of the run. The instructor also kept a log in which he documented the run specifics and his own evaluation of the run.

The results of the runs and their implications with regards to the study objectives were discussed in a daily debriefing. This debriefing was attended by all participants, representatives of Port of Rotterdam Authority and MARIN's project manager. In the final judgement of a simulation the opinion of the pilots is weighted heavily, since they are best fitted to compare the simulations with the actual situation.

In section 4.4 the presentation of simulator signals is explained. In section 4.5 the evaluation criteria are discussed and in section 4.6 the runs are discussed.

4.4 Presentation of the results

The results of the simulations are presented in track and data plots (see appendix A). For each run a track plot of the run is included, showing the position of the vessel every 30 seconds. Closest points of approach towards ships or embankment are annotated. The following data is presented against the time (# indicates the run number):

Environmental plot (#.b), see Figure 4-4:

- Wind velocity [m/s];
- Wind direction from [deg];
- Longitudinal water speed and ground speed [m/s] in one plot;
- Transverse water speed and ground speed [m/s] in one plot.

Ship data 1 plot (#.c), see Figure 4-5:

- Heading [deg];
- Rudder angle [degrees] (negative for port rudder angles);
- Speed through water [m/s];
- Propeller revolutions [rpm];
- Thrust force delivered by main engine [kN].

Ship data 2 plot (#d), see Figure 4-6:

- Longitudinal speed ship through water and over ground [m/s] in one plot;
- Transverse speed ship fore and aft [m/s] in one plot;
- Rate of Turn [degrees/minute];
- Safety-index [-];

The following data is presented against the track. The in- and outgoing reference tracks are plotted in Figure 4-8.

Evaluation path plot (#.e), see Figure 4-7:

- Swept path [m];
- Distance of track [m];

Due to an error in the data logging the tug forces could not be extracted with the same tools as the other data. In some runs other data was also not logged correctly. The missing data has been extracted from the Dolphin debriefer. An example of the presentation is shown in Figure 4-9.

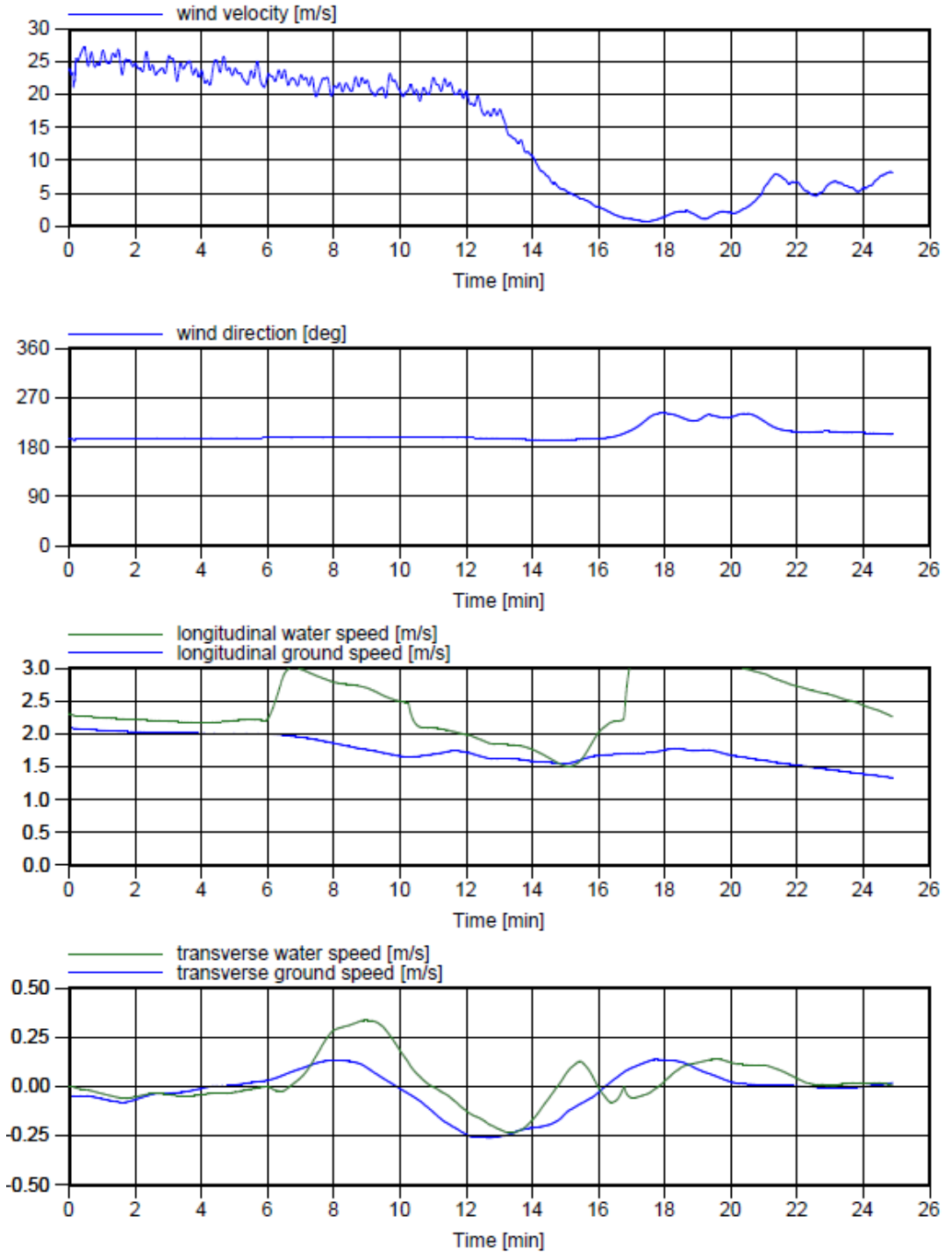

Figure 4-4 Example of an environmental plot

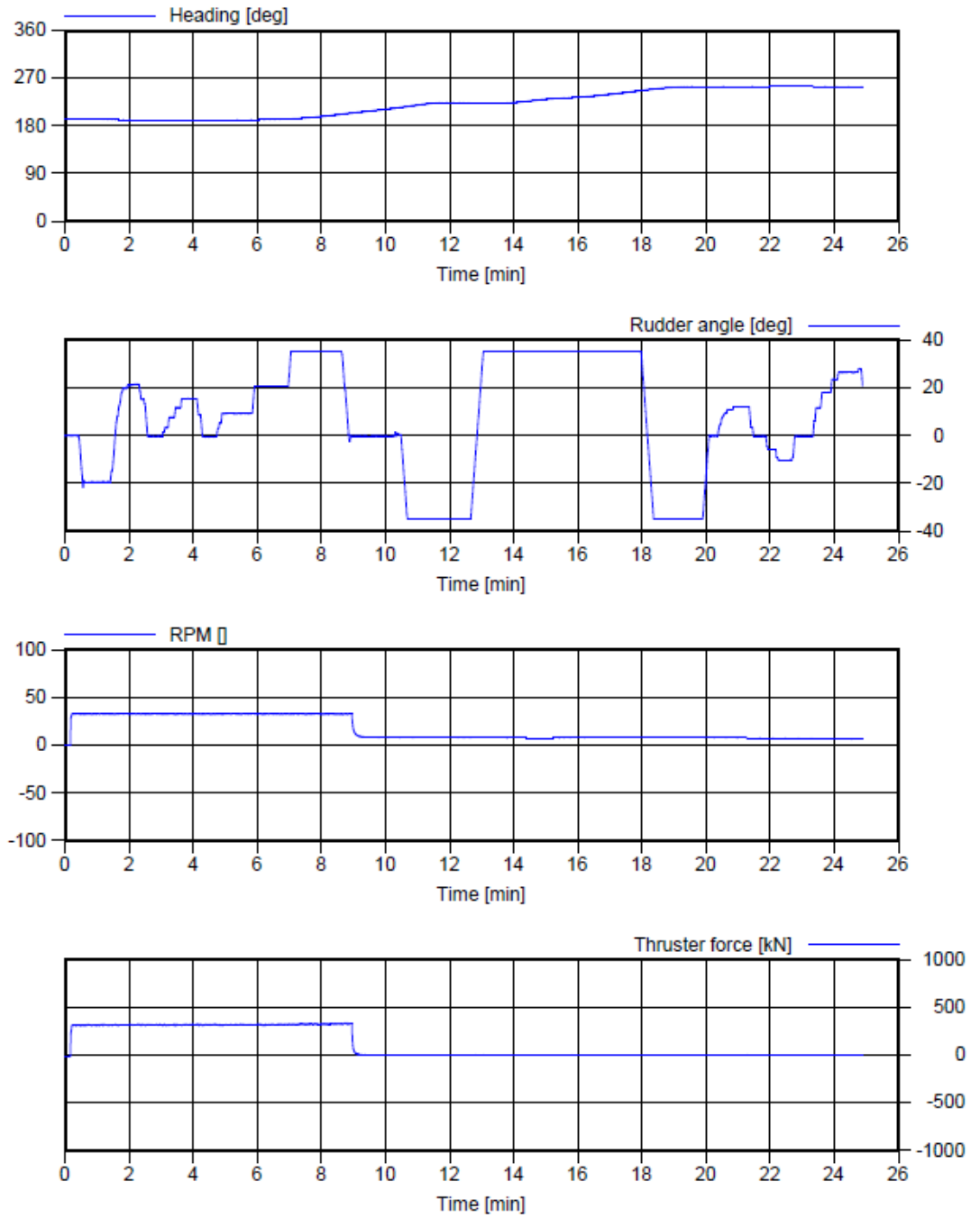

Figure 4-5 Example of a 'Ship data 1' plot

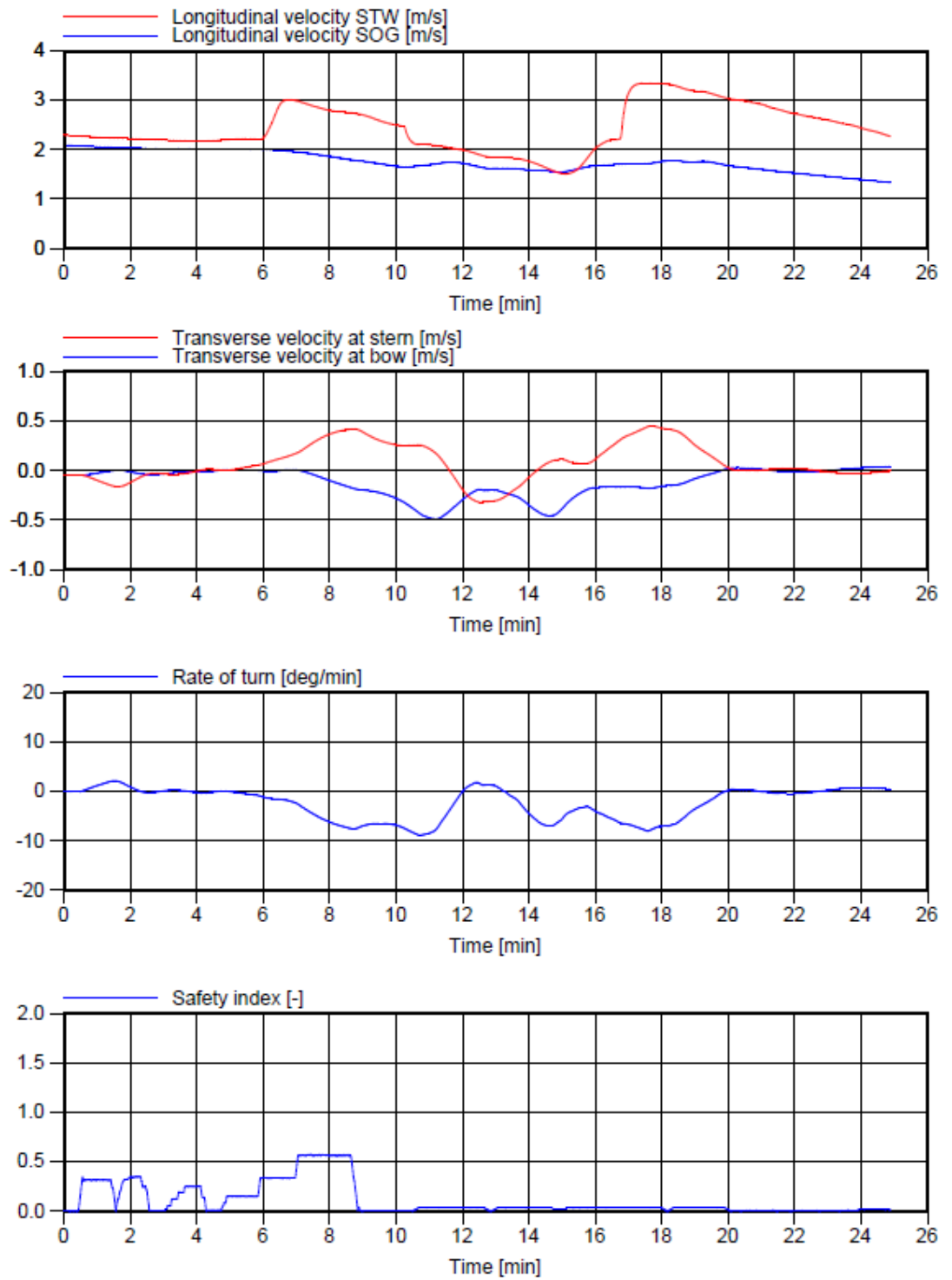

Figure 4-6 Example of a 'Ship data 2' plot

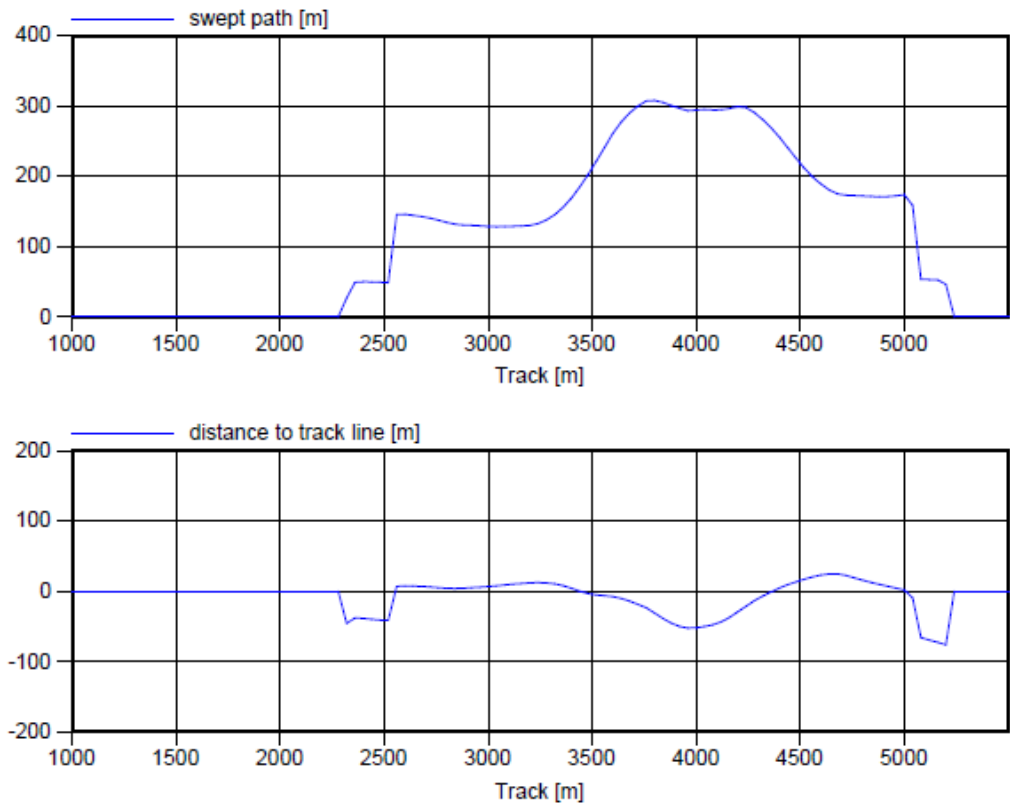

Figure 4-7 Example of an 'Evaluation path' plot

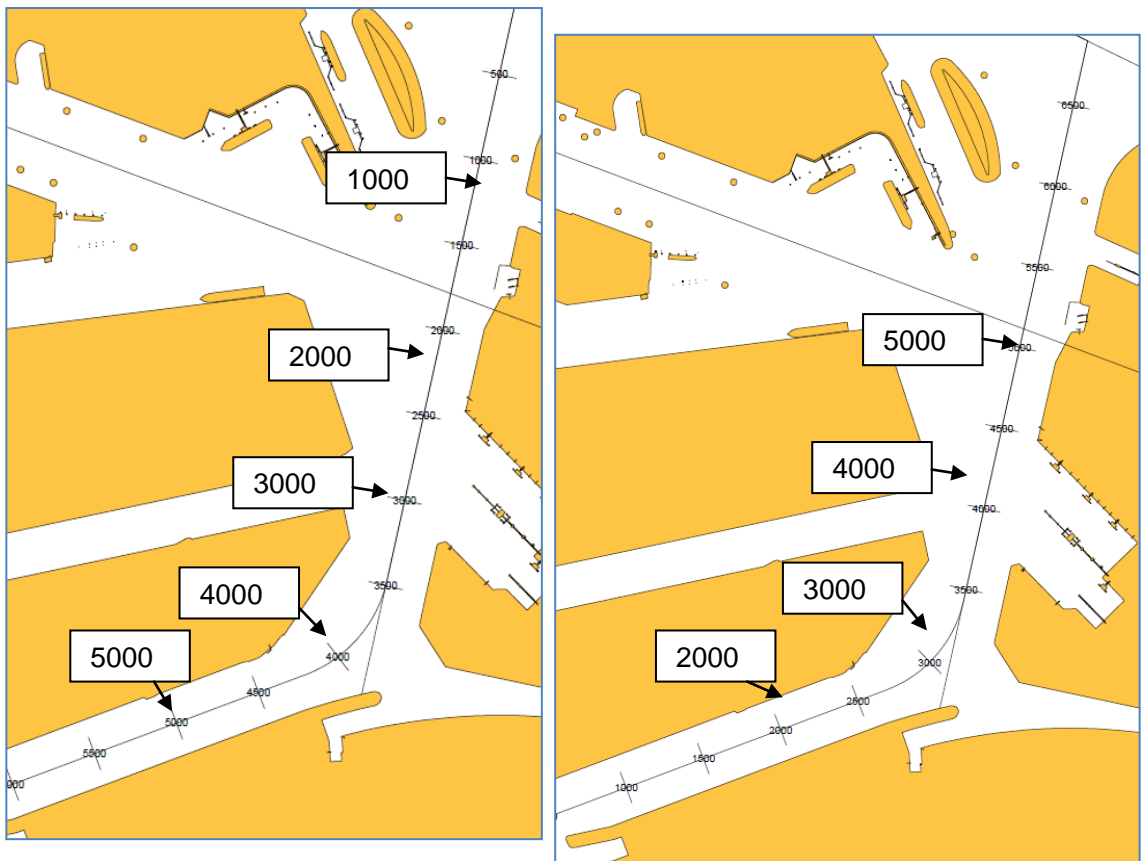

Figure 4-8 Reference tracks (left ingoing, right outgoing).

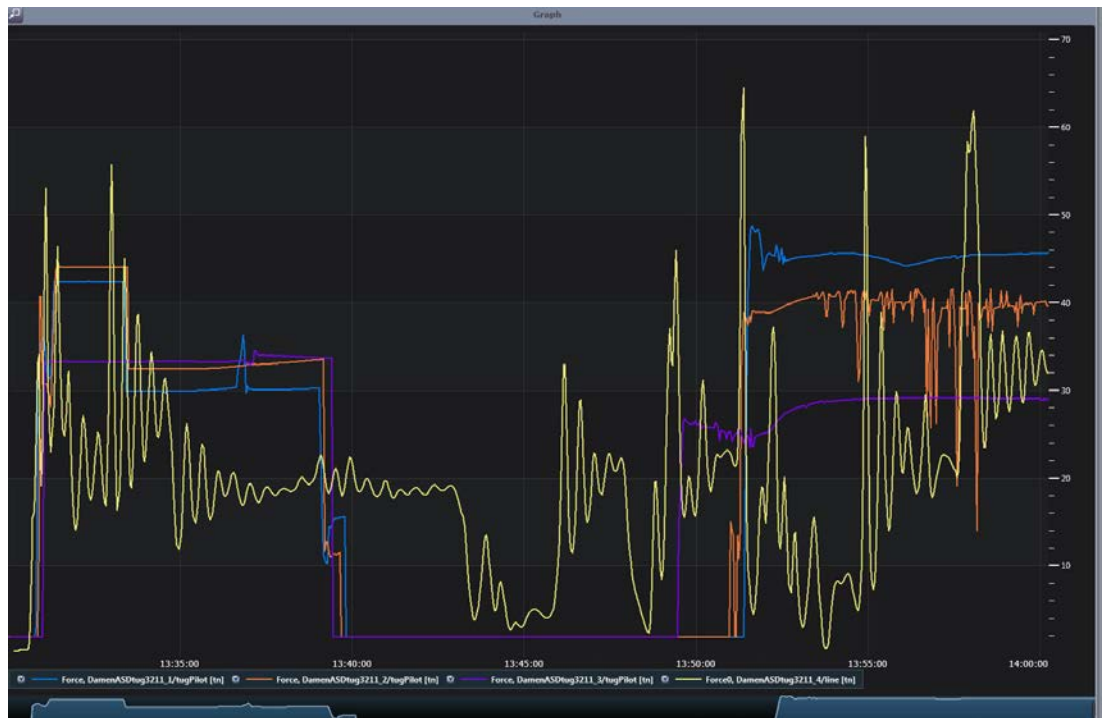

Figure 4-9 Example of a tug plot made with 'debriefeer'

4.5 Criteria for the analyses

In this section the criteria used for the evaluation of the simulation runs are discussed. In the standard MARIN methodology the analysis of the simulations focuses on two elements:

- The used space, in particular the minimum distances towards dangerous points;
- The controllability of the vessel.

The criteria used in this study enable a good comparison between the runs. As already mentioned, the decision about the safety of a run relied heavily on the opinion of the pilots.

4.5.1 Space used

PIANC guidelines prescribe minimum distances towards fixed objects or shallows. This minimum distance is given as a function of the ships beam and ranges between 0.5 and 1.3 B (B = ships beam). For fast and hard embankments and fast sailing vessels a bank clearance of 1.3 B is given. The Port of Rotterdam Authority has developed its own method to calculate the dimensions for ports and fairways. Starting point is a value (Ws_0) based on the ship size². The reasoning behind this, is that the mass of the ship is representative for the sluggishness of the ships reaction to external forces. The initial value is multiplied with the sum of four coefficients (fs1 through fs4) to derive the recommended safety margin for different situations. In Table 4-1 a description of these coefficients is given.

² $Ws_0 = \text{deadweight}^{(1/3)}$

Table 4-1 Coefficients to calculate safety margin

Ship factors	
Wind effect	fs1
Margin on windward side	0.3
Margin on lee side	0.6
Speed	fs2
2 knots	0.0
4 knots	0.1
6 knots	0.3
8 knots	0.5
Risk for own ship	fs3
Low	0.0
Medium	0.1
High	0.2
Very high	0.3
Risk for object	fs4
Slopes	0.0
Empty quay	0.1
Moored ship	0.2

In the following table the recommended safety margin is given for the design ships used in this study in relation to the vessels moored at the north and south side of the Mississippihaven. The vessels with a draft of more than 19m use a different coefficient fs4 in relation to the ships on the new terminal, since the embankment protects the moored ships to a certain extent. For the Vale Max in ballast the same criteria as used for the Capesize bulk carrier were used.

Table 4-2 Safety margins for different situations

Ws0	Vale Max loaded				VLCC loaded				Capesize bulk carrier loaded			
	74m		67m		55m							
Wind direction	NW & W		SSW		NW & W		SSW		NW & W		SSW	
Side of basin	S	N	S	N	S	N	S	N	S	N	S	N
fs1	0.6	0.3	0.3	0.6	0.6	0.3	0.3	0.6	0.6	0.3	0.3	0.6
fs2	0.1	0.1	0.1	0.1	0.1	0.1	0.1	0.1	0.1	0.1	0.1	0.1
fs3	0.0	0.0	0.0	0.0	0.1	0.1	0.1	0.1	0.0	0.0	0.0	0.0
fs4	0.0	0.2	0.0	0.2	0.0	0.2	0.0	0.2	0.2	0.2	0.2	0.2
Safety margin	51.6	44.2	29.5	66.3	53.6	46.9	33.5	66.9	49.9	33.2	33.2	49.9

The guidelines above are valid for a vessel manoeuvring on its own power. In the final part of a mooring manoeuvre the vessel is assisted by tugs and velocities are much lower. If the vessel is well under control smaller distances may be acceptable, in this case the judgement of the pilots is most important.

In the analysis these criteria are used without an extra allowance for position inaccuracy. For each run an evaluation is made regarding the space/width used:

- + The minimum safe distances are never exceeded during the entire run.
- +/- The minimum safe distances are exceeded, but the vessel remains clear of dangers.
- A part of the vessel crosses the channel edges or collides with a moored ship. Resulting in grounding/ collision or a near miss.

It should be noted that when emergency situations are simulated it is in general likely that the distance criterion will be exceeded. In such a case it is more a case of staying clear of dangers or not.

4.5.2 Controllability

To get a good impression of the controllability of a manoeuvre, the use of manoeuvring devices was studied. The aim is to quantify the manoeuvring reserve. The manoeuvring reserve is the margin between the available and the used manoeuvring power. The engine- and rudder use have been studied and the reserve power of the tugs has been analysed. The reserves are required to cope with unexpected events and emergency situations. In such circumstances it is acceptable that criteria are exceeded as long as the situation is resolved. When and to what extent criteria are exceeded provides insight in the difficult parts of a manoeuvre, and can be studied to optimize the operation.

Use of steering means

When the rudder use is studied, this must be done in cohesion with the engine use. The combination of rudder angle and engine power, is representative for the steering power that can be applied with the rudder and the steering reserves that are available at a certain moment. To evaluate the reserves in steering power a safety index is defined as follows:

Safety index

$$= \frac{\delta \cdot n^2}{\delta_{crit} \cdot n_{crit}^2}$$

With:

- δ rudder angle (degrees);
- n propeller revolutions (revolutions per minute);
- δ_{crit} rudder criterion (20 degrees);
- n_{crit} engine criterion (half ahead)

For ship speeds larger than one knot, the safety index should be less than 1. When this criterion is exceeded for more than one minute, the margins are regarded unsafe. For speeds under one knot, the controllability is mainly in hands of the tugs. Therefore, the safety-index is not used in these circumstances.

For each run an evaluation is made regarding the steering reserves, the reserves are judged as follows:

- + The safety-index is never exceeded during the entire run.
- +/- The safety-index is exceeded, but not more than one minute consecutively.
- The safety-index is exceeded for more than one minute consecutively.

Tug use

During the simulations different tug configurations were used. For each case it was studied if the assisting tugs provided sufficient reserves. A safety margin is needed to deal with unexpected events and emergencies and to compensate for the tendency of tugs to become less efficient over time. To get more of an idea of the reserves fore and aft, we looked at the use of the aft tugs together and the fore tugs together. For example, when one of the bow tugs is used at 100%, but the other one is not used, there is still 50% reserve available.

The tug use is judged as follows:

- + When the used bollard pull of the tugs was less than 70% of the available bollard pull during the entire run.
- +/- When the used bollard pull of the tugs exceeded 70% of the available bollard pull, but not more than one minute consecutively.
- When the used bollard pull of the tugs exceeded 70% of the available bollard pull for a prolonged period.

4.6 Discussion of the results

The runs executed during this study are summarised in Table 4-3. The table includes the scenarios, the vessels and the environmental conditions used during the simulations. In this table all directions for wind are 'coming from' and the wind speed is measured at location Noorderhoofd. The current column describes the current in Beergat. During the program the simulator instructor kept a narrative in which he shortly commented on the execution of each run, this narrative is included in Appendix D. The runs were also evaluated by the pilots. These questionnaires are included in Appendix E.

Table 4-3 *Run overview*

Run	Scenario	Ship	Wind [m/s]	Current
16-1	Arrival	Capesize 292x45x18.5	SSW 10	Ebb
16-3	Arrival	Capesize 292x45x18.5	SSW 15.5	Ebb 1 kts
16-4	Arrival	Capesize 292x45x18.5	NW 15.5	Flood 1 kts
16-5	Arrival	Capesize 292x45x18.5	NW 15.5	Flood 1 kts
16-6	Arrival	VLCC 332x58x21.0	SSW 15.5	Flood 1 kts
16-7	Arrival	VLCC 332x58x21.	NW 15.5	Flood max
16-8	Arrival	Valemax 362x65x22.6	W 15.5	Flood max
16-9	Arrival	Valemax 362x65x22.6	SSW 15.5	Flood max
17-10	Departure	Valemax 362x65x14.0	NW 15.5	Slack HW
17-11	Arrival with turn	Valemax 362x65x22.6	SSW 15.5	Slack LW
17-12	Arrival with turn	Capesize 292x45x18.5	SSW 15.5	Slack LW
17-13	Arrival	Capesize 292x45x18.5	NW 15.5	Flood max
17-14	Arrival	Valemax 362x65x22.6	SSW 15.5	Slack HW
17-15	Arrival	Capesize 292x45x18.5	SSW 15.5	Ebb max
17-16	Arrival	Capesize 292x45x18.5	NW 15.5	Ebb max
17-17	Departure	Valemax 362x65x14.0	SSW 15.5	Slack HW
17-18	Departure	Valemax 362x65x14.0	SSW 15.5	Slack HW
18-19	Arrival	Capesize 292x45x18.5	NW 15.5	Ebb max
18-20	Arrival	Capesize 292x45x18.5	SSW 15.5	Ebb max
18-21	Arrival	Valemax 362x65x22.6	NW 15.5	Flood Max
18-22	Arrival	Valemax 362x65x22.6	SSW 15.5	Flood Max
18-23	Arrival	Capesize 292x45x18.5	SSW 15.5	Ebb Max f1.3
18-24	Departure	Valemax 362x65x14.0	W 15.5	Slack HW
18-25	Arrival	Capesize 292x45x18.5	NW 15.5	Ebb Max f1.3
18-26	Arrival	VLCC 332x58x21.0	W 15.5	Ebb Max f1.3

The results of similar runs are summarized in a table. The following information is provided in the table.

1	2	3	4	5	6	7	8	9	10	11	12
Run	Emerg- ency	Ship	Wind [m/s]	Current	Tug use		SI	Min. dist. [m]		pilots	Over all
					fore	aft		up	lee		
# Arr	Black- out	Capesize 292x45x18.5	NW 15.5	Flood 1 kts	II	I	+/-	100	100	+	+

Column 1: Run number, with the addition Arr for arrival scenarios and Dep for departures. When the vessel is turned, this is marked with a *.

Column 2: This describes the emergency that was introduced during the simulation. The following descriptions are used for the different scenarios:

- Black out: an engine failure resulting in loss of propulsion
- Tug: a tug failure resulting in loss of assistance

Column 3: Vessel description and main dimensions in m;

Column 4: Wind in m/s, the direction is coming from;

Column 5: Description of current;

Column 6&7: Evaluation of the tug use fore and aft. First the number of tugs is displayed in Roman numbers. If a tug was failed during the run, this number is coloured red. Next to this the evaluation of the tug use according to the criteria described in section 4.5 (+, +/-, -) is given;

Column 8: Evaluation of the safety index (SI) according to criteria described in section 4.5 (+, +/-, -); The colour code is also used. When an engine failure was initiated, this field is coloured blue.

Column 9&10: The minimum distances to dangers upwind and downwind side of the Mississippihaven are given. An evaluation of the space used according to criteria described in section 4.5 is also given using colour codes.

Column 11: Evaluation of the run by the pilot executing the manoeuvre. The following rating was used:

+ Safe
+/- Acceptable
- Not safe

Column 12: Overall evaluation of the run, taking into account the numerical criteria and the judgment of pilots and simulator instructor. The following rating was used:

+	Safe
+/-	Acceptable
-	Not safe

In the following sections the runs are discussed per ship type and are grouped for comparable situations. The following distinction is made:

- Arrivals with capesize bulk carrier
- Arrivals with Vale Max bulk carrier
- Departures with Vale Max bulk carrier
- Arrivals with VLCC

4.6.1 Arrivals with capesize bulk carrier

The runs with the capesize bulk carrier were done to investigate the risk of a collision with the vessels moored on the new tank terminal. This vessel with a draft of 18.5 m is just able to pass over the embankment in front of the first two berths, where the water depth is 19m. These vessels are in general not very manoeuvrable, with little reserves in power. The vessel used in this study proved even less manoeuvrable than the capesize bulk carriers the pilots are used to, the results from this study are therefore conservative. The present guidelines prescribe that vessels with a draft of less than 19m and moor starboard side to (so they don't have to swing), are allowed to make the manoeuvre during flood current and with ebb currents less than 1 kts.

The results of runs with flood current are summarized in Table 4-4. These runs were not problematic. The flood current is weak and is ingoing at the moment the run starts in front of the Amazonehaven. In the Beergat the current is met by the flow coming out of the Mississippihaven, which results in a weak (+/- 0.3 kts) east running current into the Hartelkanaal. This flow is quite homogeneously distributed over the layers. The flood current may counter the starboard turn somewhat, but since the current is very weak this effect is not significant. This phase of the tide is benign because, once the current remains head on during most part of the turn and the transit through the Mississippihaven.

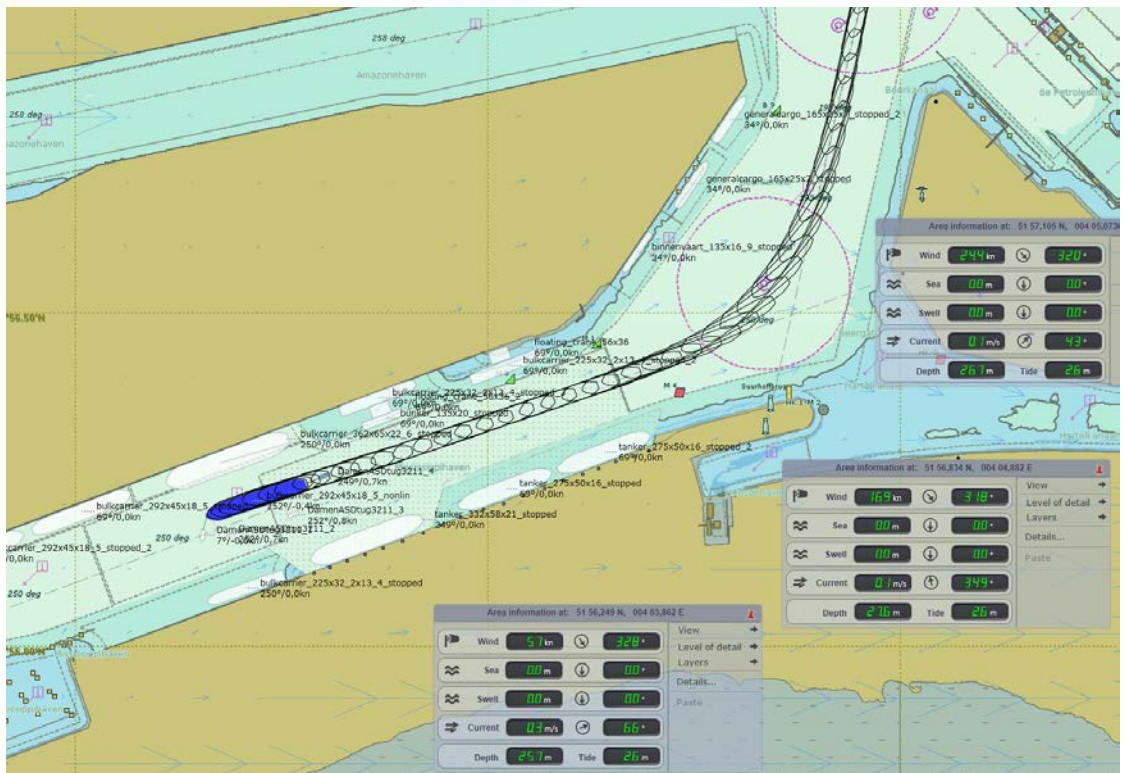

Figure 4-10 Trackplot of run 16-5, showing the benign flood current

After some runs it became clear that if the black-out occurs during the turn, the tug can quite easily maintain the turn going. Therefore, in later runs the black-out was timed before the Rate of Turn was built up. Easing the turn can be done without excessive use of the tugs. It can be concluded that entry under flood conditions can be executed safely and does not constitute a high risk to the moored vessels at the new tank terminal.

One arrival (run 17-12) was made in which the vessel had to moor portside to. In such circumstances the regulations stipulate that the turning should be executed during slack tide. This manoeuvre is normally executed with four tugs. However, during this

manoeuvre one of the fore tugs broke down. This was resolved by using the second bow tug on full power. The turn was completed successfully and throughout the transit through the basin the vessel was well under control, keeping ample clear of the moored ships.

Table 4-4 Results of runs with capesize bulk carrier in flood current and during slack

1	2	3	4	5	6		7	8	9		10	11	12
					Run	Emergency			Ship	Wind [m/s]			
16-4	Black-out	Capesize 292x45x18.5	NW 15.5	Flood 1 kts	II	I	-	101	91	+	+		
16-5	Black-out	Capesize 292x45x18.5	NW 15.5	Flood 1 kts	II	I	+	62.4	132	+	+		
17-13	-	Capesize 292x45x18.5	NW 15.5	Flood max	II	I	-	60.7	99	+	+		
17-12	-	Capesize 292x45x18.5	SSW 15.5	Slack LW	II	II	-	103	106	+	+		

The focus of the study shifted to arrivals in ebb conditions combined with emergencies. The ebb current is regarded as the most difficult condition. In Figure 4-11 the trackplot of an incoming bulk carrier is shown with the typical flow pattern during ebb. It is clear that the water flow from the Hartelkanaal will initially help to build up the Rate of Turn to starboard. The difficult part is to ease the turn once the fore part of the vessel has passed the current gradient and the aft part still experiences the full flow. In this part of the manoeuvre the vessel will turn to port. The current strength was increased when the first runs were performed successfully, and eventually runs were conducted with the maximum ebb current + 30%.



Figure 4-11 Ebb current (layer 1)

In all the ebb runs an emergency, in most cases a black-out, was initiated. Table 4-5 shows the results of the runs executed with ebb current.

Table 4-5 Results of runs with capesize bulk carrier in ebb current

1 Run	2 Emergency	3 Ship	4 Wind [m/s]	5 Current	6, 7 Tug use		8 SI	9, 10 Min. dist. [m]		11 pilots	12 Overall
					fore	aft		up	down		
					16-3 Arr	Black-out		Capesize 292x45x18.5	SSW 15.5		
17-15 Arr	Black-out	Capesize 292x45x18.5	SSW 15.5	Ebb max	II	I	+/-	108	91.9	+	+
17-16 Arr	Tug	Capesize 292x45x18.5	NW 15.5	Ebb max	II	I	-	123	68.6	+	+
18-19 Arr	Tug	Capesize 292x45x18.5	NW 15.5	Ebb max	II	I	-	116	101	+	+
18-20 Arr	Black-out	Capesize 292x45x18.5	SSW 15.5	Ebb max	II	I	+/-	107	106	+/-	+/-
18-23 Arr	Tug	Capesize 292x45x18.5	SSW 15.5	Ebb Max f1.3	II	I	-	80.1	102	+/-	+/-
18-25 Arr	Black-out	Capesize 292x45x18.5	NW 15.5	Ebb Max f1.3	II	I	+	138	84.4	+	+

In all the runs the vessel is maintained well clear of any object. The safety index criterion is often exceeded in runs where the tug breaks down. With the stern tug out of order in run 17-16, 18-19 and 18-23 the standard action is to release one of the bow tugs and reconnect it at the stern. This means that a large part of the manoeuvre is carried out with only the bow tug connected. The turn is mostly controlled by the rudder and sometimes power bursts are given to increase the rudder effect. This leads to the safety index criterion being exceeded in these runs. However, the pilots maintain control over the Rate-of-Turn and the current gradient can be effectively negotiated. Once the Mississippi basin is reached the vessel is well under control and there is no danger of coming close to the tankers on the south side of the Mississippihaven. Here the cross currents are no longer present and the wind effect is also small in this sheltered area.

In the runs with an engine black out the tug-use is in general very high. Without the thrust of the propeller, the rudder is not very effective and the Rate-of-Turn has to be built up and checked by the tugs. With speed ahead only the stern tug is effective. In run 18-20 the full force of the stern tug was used to stop and even reverse the bulk carrier in the turning circle. After it was stopped the engine came back on line and the run was resumed mostly relying on engine and rudder. In general the pilots felt they had sufficient tug power available to conduct the manoeuvre without the engine.

All in all it can be concluded that with three tugs there are sufficient reserves built in to safely enter the Mississippihaven under the tested conditions. Even in conditions with wind force 7 and the maximum ebb current, multiplied by a factor 1.3, the entrance could be made without coming close to any obstacle. Of course the remaining means are used extensively in these situations, but that is what the situations asks for.



Figure 4-12 Entrance manoeuvre with Capesize bulk carrier

4.6.2 Arrivals with Vale Max bulk carrier

One of the objectives of this study is to answer the question if a loaded Vale Max ship can safely enter the Mississippihaven, given the maximum mooring configuration at the north and south side of the Mississippihaven? The answer has to be based on the horizontal tide limits that are currently in force. These stipulate that a vessel with a draught of > 19m can only pass Beergat with a flood current when they moor starboard side alongside the berth. If they have to turn upon arrival and the draught exceeds 18m, than the Beergat has to be passed at slack water of HW in order to exclude the ebb current in Beergat.

The results of the runs with the Vale Max in loaded conditions are summarized in Table 4-6 and the track plots are shown in Figure 4-13 .

Table 4-6 Results of arrival scenarios with Vale Max (loaded)

1 Run	2 Emerg- ency	3 Ship	4 Wind [m/s]	5 Current	6, 7 Tug use		8 SI	9, 10 Min. dist. [m]		11 pilots	12 Over all
					fore	aft		up	lee		
16-8 Arr	-	Vale Max 362x65x22.6	W 15.5	Flood max	II	II	+	44.1	65.3	+	+
16-9 Arr	-	Vale Max 362x65x22.6	SSW 15.5	Flood max	II	II	+/-	104	45.1	+	+
17-11 Arr*	-	Vale Max 362x65x22.6	SSW 15.5	Slack LW	II	II	+/-	91	52.5	+	+
17-14 Arr	-	Vale Max 362x65x22.6	SSW 15.5	Slack HW	II	II	+/-	68.3	80.6	+	+
18-21 Arr	Black- out	Vale Max 362x65x22.6	NW 15.5	Flood Max	II	II	+	>100	0	-	-
18-22 Arr	Tug	Vale Max 362x65x22.6	SSW 15.5	Flood Max	II	I	+/-	86.7	78	+	+

In run 16-8 and 16-9 the fore tugs were used up to 100% for a few minutes. This happens when the turn to starboard is commenced. In the remainder of the simulation, the tug use remained within limits.

In run 17-11 the arrival is made at slack water and the Vale Max is turned around in the turning circle. The engine is used to slow down the vessel and the ship is swung with the aid of the stern tugs. The largest part of the turn the tugs work at 70%, however the final part of the turn both aft tugs are used at 100%. The turn is checked with the bow tug only. During the transit in the basin only small corrections were necessary. In run 17-14 and 18-22 the tug use remained within limits throughout the simulation.

The pilots indicated in all runs, except run 18-21, that they had sufficient tug power available and that they could maintain good control over the vessel. In runs without an emergency they are able to stay on track in the Mississippihaven, keeping sufficient distance to the moored ships. In some cases the moored ship closest to the berthing position of the Vale Max is passed at distances that are strictly speaking exceeding the criterion, however this happens deliberately since the vessel is than in the process of its final approach to the berth.

Run 18-21 is a run in which the turn to starboard was initiated quite late by the pilot. Furthermore, this moment coincided with the moment an engine black out was initiated. Therefore, the tugs had to be used to create the required Rate-of-Turn. With a speed through water of 4.5 kts the tugs are also not very effective yet. This resulted in a very wide turn and the vessel ended with the side in the embankment on the south side of the Mississippihaven. When the embankment is grazed under a large angle like this, the chances of penetrating it, are minimum. The grounding constituted no danger to the moored ships at the new tank terminal. Based on these runs it can be concluded that the mooring configuration tested in these simulations has no effect on the safety of the entrance manoeuvre of the Vale Max. Within present guidelines the entrance can be executed safely. Emergency situations, like a black out on a critical moment, can lead to damage, but with the present practice this can be limited. Reducing speed in an earlier stage and optimizing the tug configuration, so they are more effective in slowing down the ship, may be effective measures to increase overall safety.

16-8

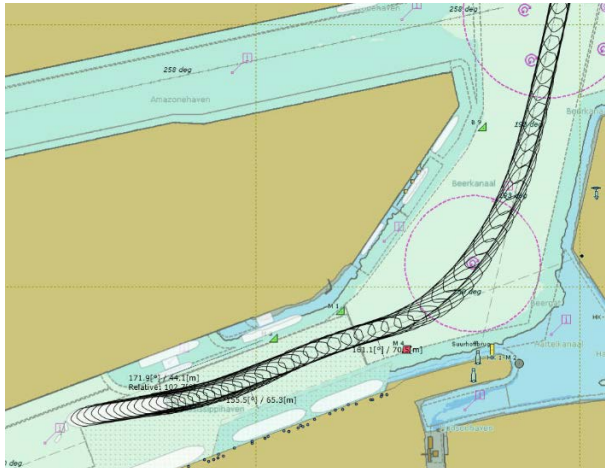

16-9

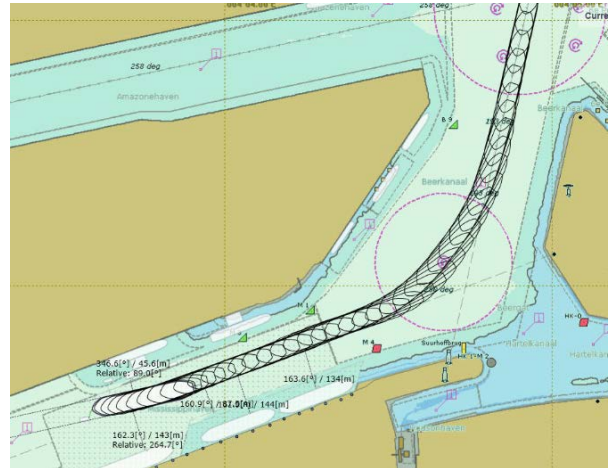

17-11

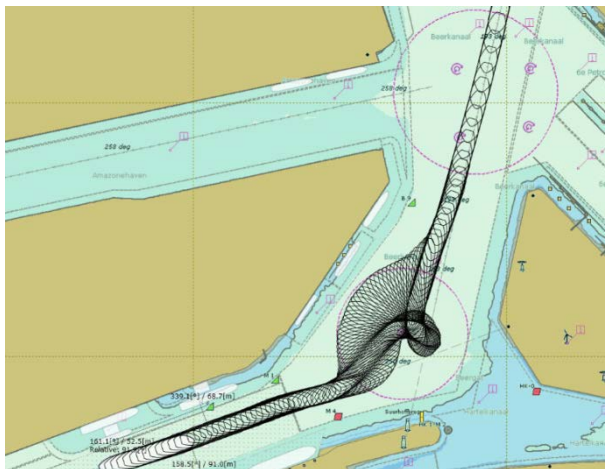

17-14

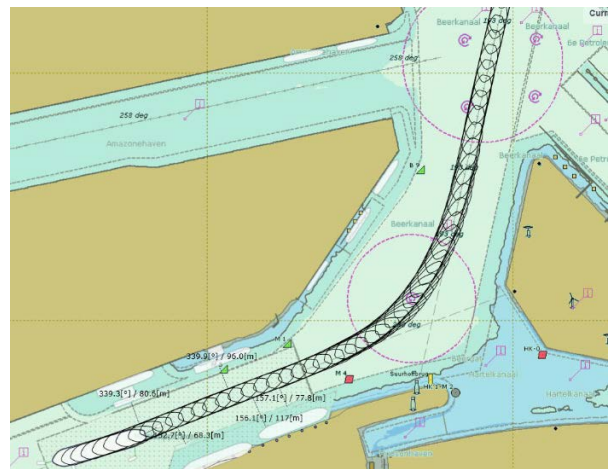

18-21

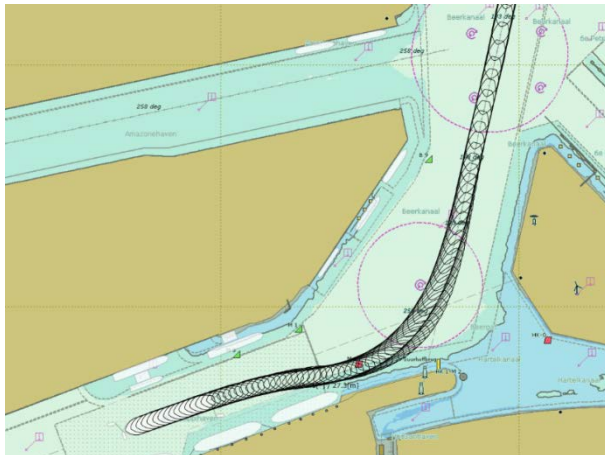

18-22

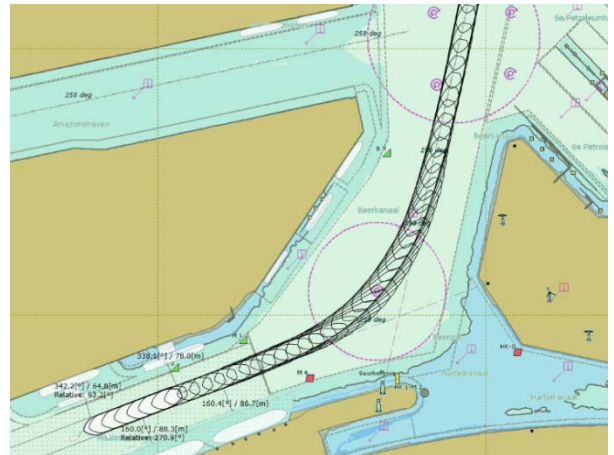

Figure 4-13 Track plots of arrival scenarios with the Vale Max bulk carrier

4.6.3 Departures with Vale Max bulk carrier

Four departure scenarios were carried out with a ballasted Vale Max bulk carrier. These runs are executed with four tugs. All runs, except run 17-17 were regarded as safe. The outcome of run 17-17 is evaluated as invalid because the orders for the tug on the port shoulder were executed incorrectly. Instead of pulling the bow away from the moored ship it was pushing at full force, which in the end led to a collision. The valid runs provide an unambiguous outcome. Little tug assistance is required to keep the ship under control, and good clearance towards the moored ships can be adhered. With speeds below 3 kts, the tugs are effective in steering the vessel, although the manoeuvring space for the tugs is somewhat limited when passing the buoys. The turn

in the turning circle seems troublesome. It is advised to turn in the wider turning circle near the 6th Petroleum terminal. When the turn is made in the Beergat, the vessel should be backed further to the east, so enough room is available when the turn is started. The positioning in the turning circle was hampered in run 17-18 due to a degraded performance of the NMS system in this stage of the run.

An empty Vale Max vessel can safely departure from the EMO terminal with strong winds and with vessels moored at the south side of the Mississippihaven

Table 4-7 Results of departure scenarios with Vale Max (ballast)

1	2	3	4	5	6	7	8	9		11	12
								10			
					Run	Emergency	Ship	Wind [m/s]	Current	Tug use	
					fore	aft	up	lee			
17-10 Dep	-	Vale Max 362x65x14.0	NW 15.5	Slack HW	II	II	+	62.5	124	+	+
17-17 Dep	-	Vale Max 362x65x14.0	SSW 15.5	Slack HW	II	II	+	>10 0	0	inv	inv
17-18 Dep	-	Vale Max 362x65x14.0	SSW 15.5	Slack HW	II	II	+	93	76	+	+
18-24 Dep	-	Vale Max 362x65x14.0	W 15.5	Slack HW	II	II	+/-	63.6	93.6	+	+

17-10

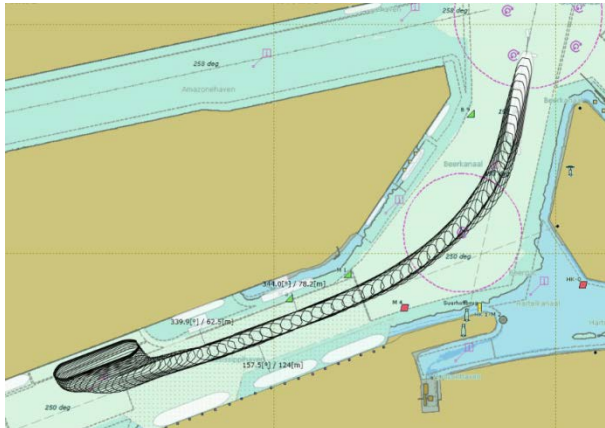

17-17

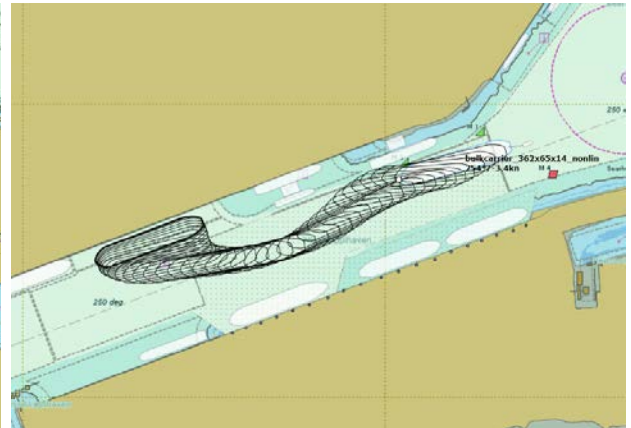

17-18

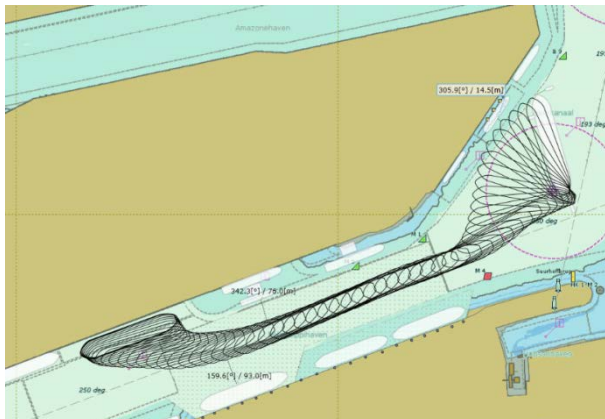

18-24

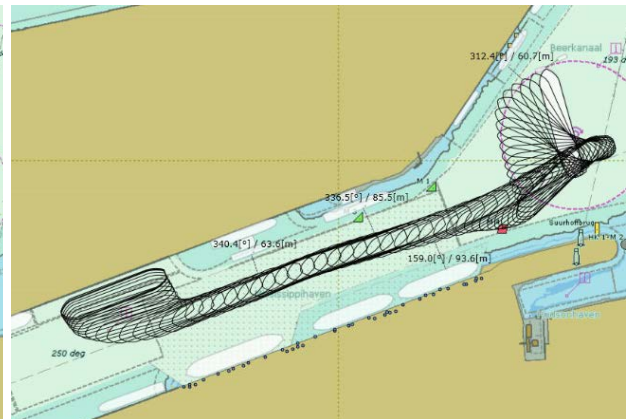

Figure 4-14 Track plots of departure scenarios with the Vale Max bulk carrier

4.6.4 Arrivals with VLCC

The safety risk for vessels moored at the new tank terminal was studied with a Capesize bulk carrier. It was reasoned that a VLCC destined for this terminal would have to make the turn with less speed to stop in time, it is therefore interesting to study this vessel as well. The VLCC with its 21m draft may enter only during flood. The results of the VLCC runs are summarized in Table 4-8.

Table 4-8 Results of arrival scenarios with a VLCC (loaded)

1	2	3	4	5	6	7	8	9	10	11	12
Run	Emerg- ency	Ship	Wind [m/s]	Current	Tug use		SI	Min. dist. [m]		pilots	Over all
					fore	aft		up	lee		
16-6 Arr	Black- out	VLCC 332x58x21.0	SSW 15.5	Flood 1 kts			+	128	63.4	+/-	+/-
16-7 Arr	Black- out	VLCC 332x58x21.	NW 15.5	Flood max			+	94.3	50.4	+/-	+/-
18-26 Arr	Black- out	VLCC 332x58x21.0	W 15.5	Flood max f1.3			+	>100	31	-	-

Three runs were executed with a loaded VLCC. The runs were executed with flood current and all three wind fields were tested. In all three runs an engine black out was simulated. In run 16-7 the speed at the start of the run was built up to 5 kts. A lot of tug power was necessary to reduce the speed to under three knots without the engine available. The Rate-of-Turn was increased only slowly, which resulted in a wide turn. Run 18-26 is a repetition of these events but now the flood current was increased with 30%. This time the pilot tried to come to a stop, but when the speed reduced too late the plan was changed and the tugs were directed to start the turn. These events plus the extra strong current led to the vessel grounding on the embankment on the south side of the Mississippihaven. The occurred with a heading almost parallel to the embankment, therefore there was no real risk of coming close to the moored tankers.

The overall evaluation of these runs doesn't look very positive. However, this is mainly based on the fact that everything was done to create the worst possible scenario. The start speed was too high; the black-out was initiated at the moment the vessel needed to reduce this speed and the extra strong flood current makes it difficult to built up the Rate-of-Turn. In the end the entrance manoeuvres did not constitute a real risk to the moored tankers. The pilots felt they could bring in the VLCC without problems under normal conditions.

To cope better with emergencies some improvements were suggested. One is to fasten the bow tug on the port shoulder. This way it can be used for braking as well, increasing the braking capacity with 25%. The drawback is that for the final berthing manoeuvre it has to let go and reposition to a pushing position, but this is hardly a problem. Wind and current conditions within the basin are generally benign and do hardly effect the loaded vessels.

Another point is the speed regime with these ships. When starting the turn, the speed should be below three knots, which means that reducing speed starts in an early stage, because this type of vessel does not slow down easily. Pilots should be aware of this and should be trained to handle black-outs in this area.

16-6

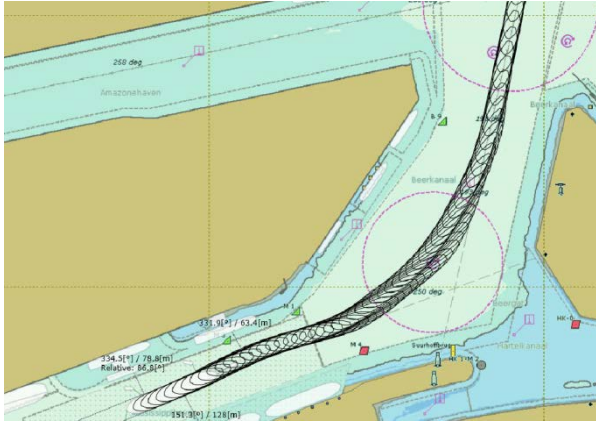

16-7

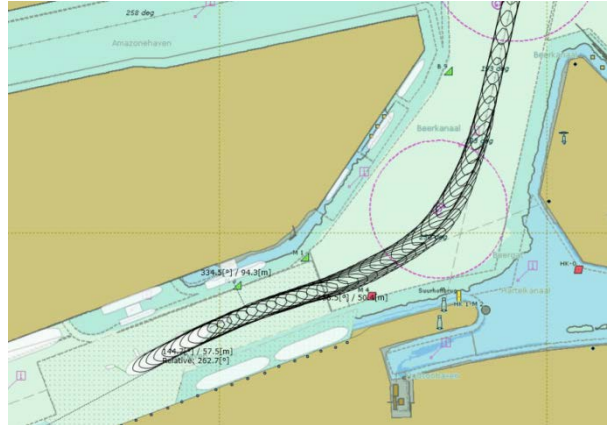

18-26

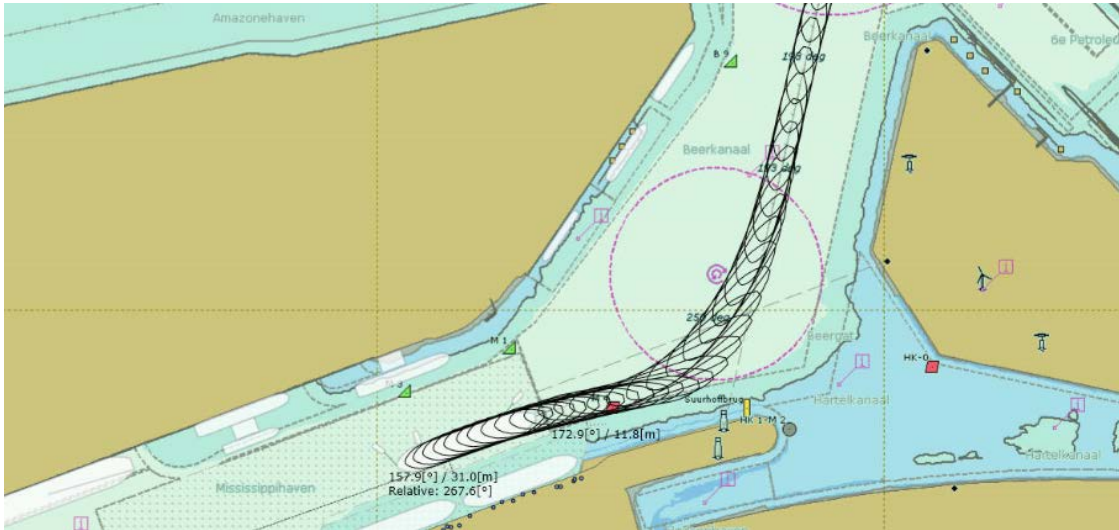

Figure 4-15 Track plots of arrival scenarios with the VLCC



Figure 4-16 VLCC entering the Mississippihaven

4.7 Passing ship forces

One of the study objectives was to determine the line forces of vessels moored at the new terminal when a VLOC passes. In Dolphin the passing ship forces can be determined real-time using potential flow theory. Due to performance issues these calculations were only executed in two runs. The interaction effects during these runs were very small and off-line calculations showed that the interaction forces calculated real time were qualitatively correct, but with a significant underestimation of the magnitudes. With Ropes software additional calculations were carried out, simulating the cases where the Vale Max passes a moored VLCC. Ropes calculates the interaction forces directly but does not take into account the line configuration. Although the Y (lateral) forces are largest in magnitude, the longitudinal X forces translate to the highest spring line forces, because they will move the ship ahead/astern.

The interaction forces have been calculated for the following cases and are plotted in Figure 4-17:

- Speed 4kts, passing distance 45m
- Speed 3.3 kts, passing distance 80m
- Speed 3.3 kts, passing distance 120m

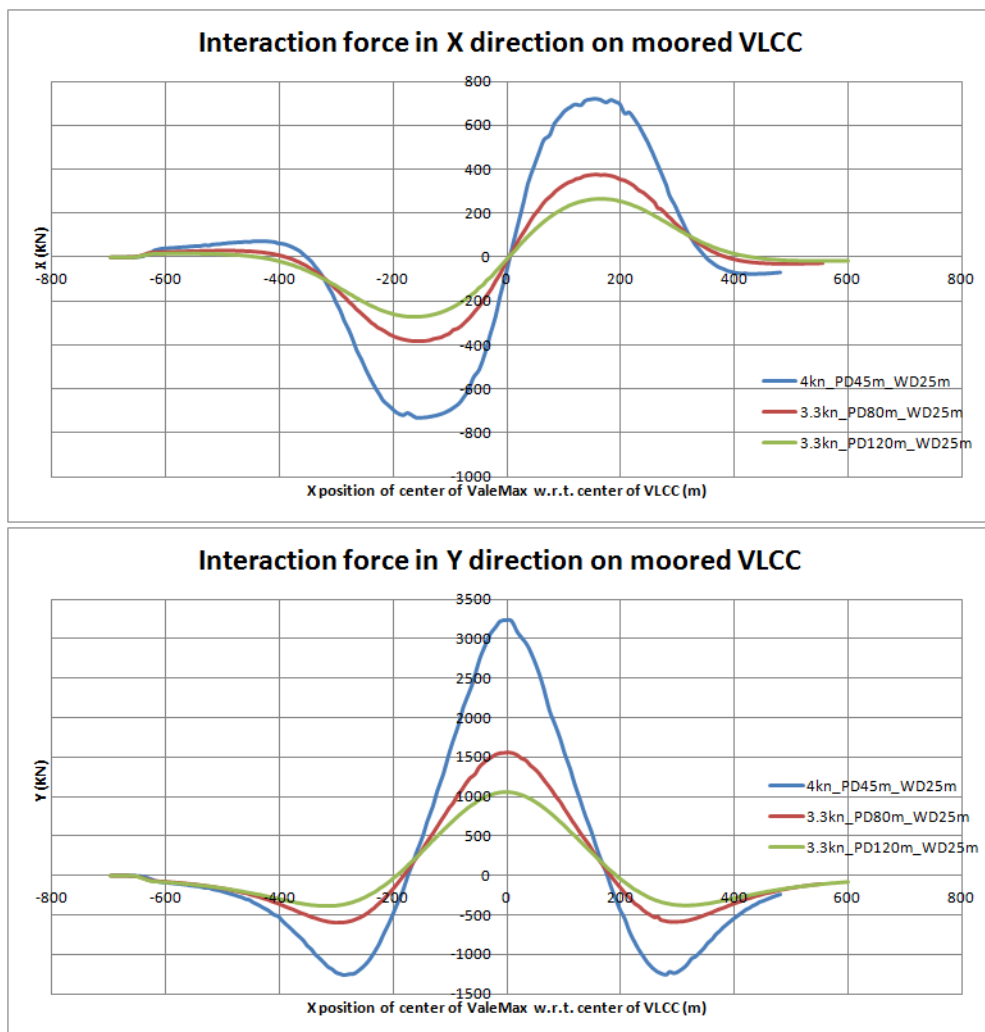

Figure 4-17 Interaction forces X and Y on moored ship, due to passing ship

With the observed sailing pattern of the Vale Max within the Mississippihaven it is not expected that speeds will be higher than 3.3 kts nor that passing distances will be smaller than 100m. A reconstruction run on the simulator produced interaction forces of

the same magnitude as described in the case above, see Figure 4-18 for the results. The advantage of this approach is that the interaction forces can be related to the mooring line loads in the simplified mooring configuration. Note that in reality the loads will be spread over more lines and fender friction will dampen the ship movements. With loads in the simplified mooring configuration lower than 30 tons, it can be concluded that in reality the mooring line forces will be low. A 'normal' passage of the Vale Max does not lead to excessive forces in the mooring lines of the moored ships.

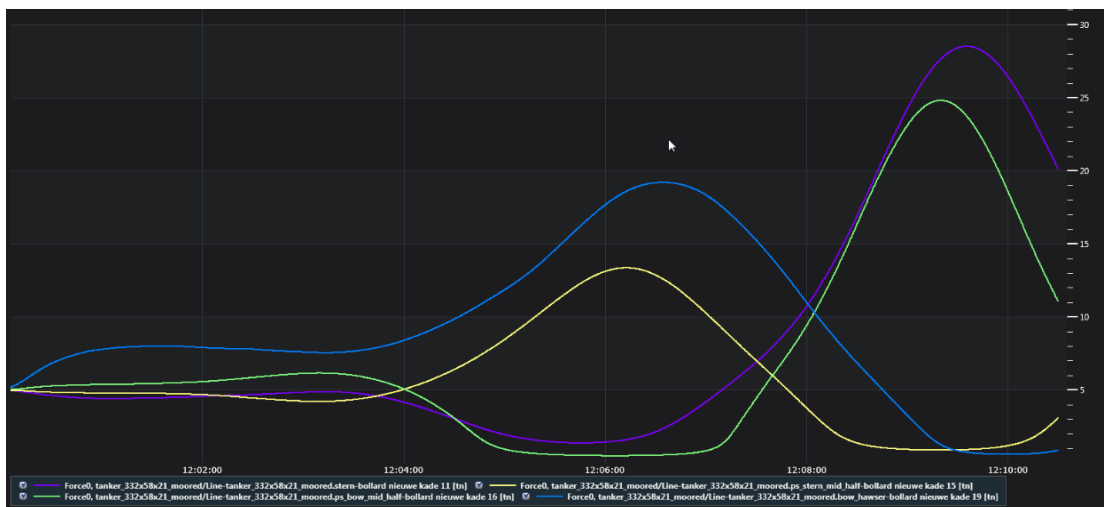
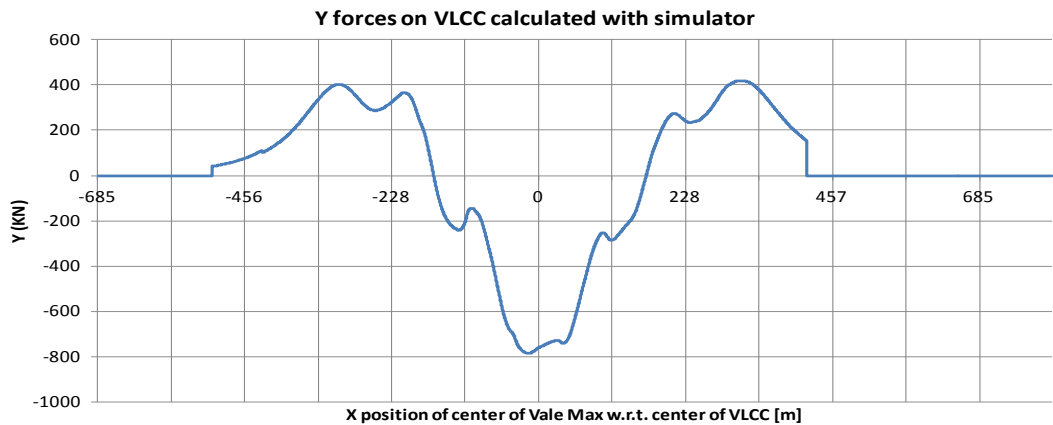
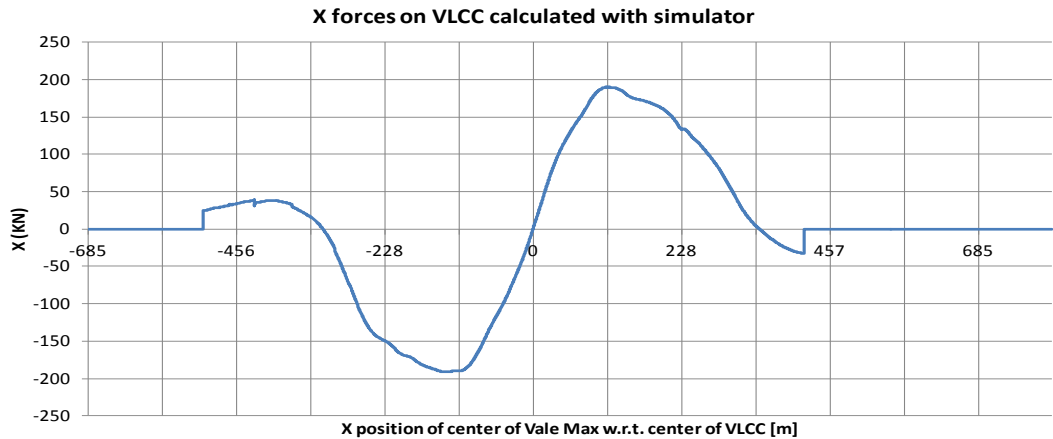

Figure 4-18 X forces (upper), Y forces (middle) and line forces (lower) experienced by moored VLCC.

5 CONCLUSIONS AND RECOMMENDATIONS

Based on the evaluation of the simulations the following can be concluded and recommended:

- The safety hazards of the moored vessels close to the turning basin were investigated with real-time simulations in which emergencies were simulated with a Capesize bulk carrier at a draft of 18.5m. The admittance policy and procedures are adequate and the presently used tug configurations provide sufficient reserves to handle emergencies in a controlled manner. Even under extremely adverse conditions and unfavourable timing of emergency events it was possible to stay well clear of the tankers at the new tank terminal.
- The safety hazards were also investigated with a Vale Max and a VLCC in fully loaded condition. Due to their inertia and size these vessels are most difficult to control in an emergency. Grounding on the embankment in front of the tank terminal could not be avoided under all conditions, but this occurred on headings almost parallel to the embankment. With such headings the embankment will not be penetrated in such a way that a collision with the moored tankers is possible.
- The impact of the new terminal on vessels destined for the EMO terminal is minimal. The Vale Max in loaded condition can safely enter the basin, given the maximum mooring configuration on the north and south side of the Mississippihaven.
- The empty Vale Max can safely depart from the EMO terminal with strong winds and with vessels moored at the south side of the Mississippihaven. Swinging in the turning circle was the most difficult part of the manoeuvre and it is advised to execute the turn in the turning circle close to 6th Petroleum terminal.
- The mooring forces of vessels at the new terminal were determined with additional calculations. The mooring forces remain well within the limits.
- The simulations were performed without bunker ships alongside the tankers. The presence of bunker ships would reduce the available width by +/- 20m. When this is translated to the simulation results of the Capesize bulk carriers there is only one case in which this would lead to the distance criterion being exceeded with a few meters. Considering that in the simulation program both the Vale Max and VLCC ended up on the embankment once, and considering that a bunker ship will be very close to the slope, it is not unlikely that these vessels are capable of penetrating the embankment to such an extent that a collision with the bunker ships occurs. Therefore it is recommended not to allow bunker ships alongside the most easterly tanker during the arrival of a Vale Max or VLCC.
- The position of the tanker berths is well chosen. Shifting them more to the east will bring them too close to the path of a vessel that takes a wide swing (due to e.g. a black-out). It may also increase the hindrance to inland vessels that turn in- and out of the Hartelkanaal.

- In the study performed in 2008 [1], conclusions were drafted for a layout with a navigable width of 258 m. Formally the new berths would need to be moved 12m land inward to comply with this width. The present study shows that this extra width is not required, especially if there is no bunkering on the most eastern tanker berth during arrival of Vale Max/VLCCs.
- When the same tidal regime, currently in force for the EMO terminal, is applied to the new terminal, the chance exists that regularly multiple ships need to enter during the same tidal window (flood). This may lead to conjunction and delays.
- It is advised to optimize tug configurations for emergency situations instead of berthing convenience. When the bow tug is fastened on the shoulder it can be used for braking as well, increasing the braking capacity with 25%. The drawback is that for the final berthing manoeuvre it has to let go and reposition to a pushing position, but this is hardly a problem. Wind and current conditions within the basin are generally benign and have little effect on the loaded vessels.
- Keep speed low when arriving with the Vale Max/VLCCs in loaded condition. Before starting the turn, the speed should be below three knots, which means that reducing speed starts in an early stage.
- Pilots should be trained to handle black-outs and other emergencies (e.g. tug failures) in this area.

REFERENCES

- [1.] Effecten van toekomstige ontwikkelingen op de nautische toegankelijkheid van de Mississippihaven, Eindrapport 21914.600/4, 26 February 2008, MARIN

APPENDIX A MARIN Simulators

MARIN simulators

MARIN operates full mission ship manoeuvring simulators at three different locations:

- MARIN: Wageningen, The Netherlands;
- MARIN USA: Houston, USA;
- Oceanica: Sao Paulo, Brazil.

Depending on the wishes of the client research projects, consultancy and maritime training can be done on each of these locations.

MARIN's nautical centre MSCN (Wageningen)

MARIN's nautical centre MSCN operates three different types of real-time simulators for research, consultancy and training purposes of professional mariners. The simulators can be used separately or combined in the same scenario. The steering controls can be easily adapted to the specifications of the simulated vessel. At MARIN the following 6 real-time simulators are available:

1. Full Mission Bridge I (FMBI): Especially suitable to simulate large ocean-going vessels.
2. Full Mission Bridge II (FMBII): A flexible facility, capable of simulating a wide range of vessels.
3. Four Compact Manoeuvring Simulators (CMS): Smaller simulators that can be used to simulate all kind of tugs and smaller vessels.

Full Mission Bridge I (FMBI)



MARIN
P.O. Box 28

6700 AA Wageningen
The Netherlands

This is a fully equipped bridge with 360 degrees visual projected scenery. A mock-up of a real ship bridge is located in the centre of a cylindrical projection wall on which the graphics image is projected. The diameter is 20m and the bridge house is approximately 8m by 6m. The bridge is equipped with realistic consoles and instrumentation, including bridge wing consoles. Bridge and console layout can be adapted according to client wishes or research needs.

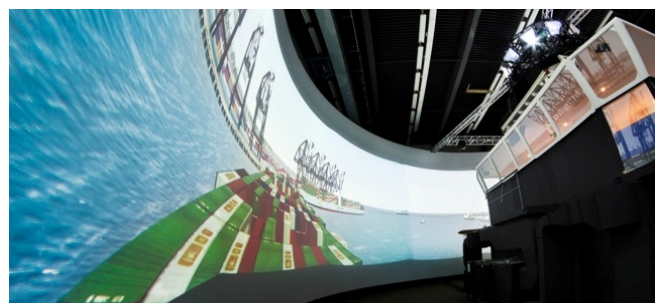

FMBI, bridge house with cylindrical projection wall

Full Mission Bridge II (FMBII)



Full Mission Bridge II (FMB II), has a 210 degrees visual projected image. In addition to the projection system, the rear view is presented on three separate displays, thus providing almost 360 degrees view. Additional viewing positions offering a 3D view from any observation point can be installed.

T +31 317 49 39 11
F +31 317 49 32 45

E info@marin.nl
I www.marin.nl

Compact Manoeuvring Simulators (CMS)

The four Compact Manoeuvring Simulators can be divided into:

- Two cubicles with 300 degrees visuals and rear-view monitor
- Two CMS with 180 degrees visuals and rear-view monitor

The four Compact Manoeuvring Simulators are based on exactly the same 'ownship' functionality as the full-mission simulators. The default configuration consists of a U-shape console with steering controls, radar, instruments and bird's eye view showing the area and position of vessels. These facilities are ideal to simulate tugs and smaller vessels, but can also be used for anchor handling or crane operations.



Mathematical modelling

In nautical simulations the mathematical manoeuvring model of the ownship is of major importance. The quality of this model can determine the outcome of a research project and the realism of training to a high degree. MSCN's models are based on extensive research into the field of ship hydrodynamics and port and waterway design. The ownship models have six-degrees-of-freedom (6 DOF) taking into account the influence of all external effects, e.g. wind, waves, tidal currents, bank suction, ship-ship interaction, etc. They are water depth/draft dependent, so the manoeuvring characteristics will vary depending on the actual water depth and the vessel's draught.

MSCN has a large database of mathematical manoeuvring models available. In addition to this, MSCN experts can prepare a dedicated model based on available model tests or manoeuvring tests.

Tugs and Targets

Tugs can be included in MSCN simulators in three different ways:

- Controlled from a simulator (FMBII or CMS)
- Instructor controlled tug model (C-tug)
- Instructor controlled forces

The most realistic option is a man controlled tug from another simulator. It has the most realistic behaviour, especially when the tug is controlled by an experienced tug master. However, the instructor controlled tug model also results in realistic behaviour of the tugs.

For the simulation of other traffic MSCN has a large number of target vessels available. Each target consists of a visual representation as well as a mathematical model for realistic manoeuvring.

Sao Paulo and Houston simulators

The simulator facilities in Sao Paulo and Houston use the same software as in Wageningen. Both facilities consist of a primary bridge and have the possibility to include a secondary bridge or Pilot/Captain station. The primary bridge has 360 degrees visuals. The secondary bridge can be used as a second vessel in the simulation or as a tug.

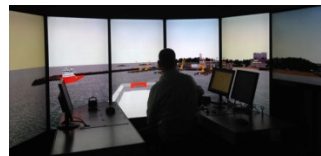

Left: Sao Paulo



right: Houston

Software

All simulators use MERMAID500 and Dolphin simulation software. This software is DNV approved.



More information

A detailed description of the capabilities of MARIN simulators is given in the 'Capability statement'. This document can be obtained through the website (www.marin.nl) or can be provided upon request.

For more information please contact MARIN's Nautical Centre MSCN;
T +31 317 47 99 11
E MSCN@marin.nl

APPENDIX B Pilot cards

Principal dimensions		Engine	
Length over all	362.00 m	Type:	Diesel
Beam	65.00 m	Power:	29260 kW
Draft fully laden	23.20 m	Max. revs:	74 rpm
Displacement fully laden	460920 tons	Bow Thruster:	- kW
Dead weight tonnage	400000 tons	Stern Thruster:	- kW

Telegraph Setting	rpm	Speed [kn]	Crash Stop RPM 52 -> -52		
			Stopping Time		
			Distance [mile]	[min]	[sec]
SEA FULL	74	14.8	1.57	20	9
HARBOUR FULL	59	11.8			
HALF	52	10.4			
SLOW	43	8.6			
DEAD SLOW	25	5.0			

Telegraph	Rudder	Advance	Transfer	T90		Tac. Diam.
		[mile]	[mile]	[min]	[sec]	[mile]
SEA FULL	P	0.61	0.29	3	30	0.63
	SB	0.62	0.30	3	36	0.64
HALF	P	0.60	0.29	5	13	0.63
	SB	0.61	0.30	5	22	0.64

WARNING:

The response of this ship may be different from that listed above if any of the following conditions upon which the manoeuvring information is based are varied:

1. Calm weather - wind 8 knots or less, calm sea.
2. No current.
3. Water depth twice vessels draft or greater.
4. Clean hull.
5. Load condition FULL LOAD

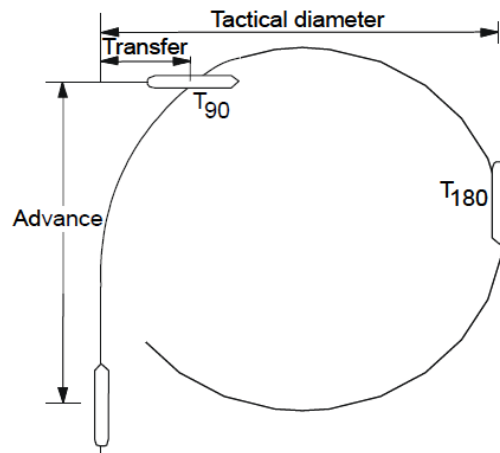

Pilot card Vale Max

Ship Generation Tool v2.0

File

Parameters Results **Pilot Card**

PILOT CARD

Ships name **tanker_333x60x21-0.os** Date 11/02/16
 Call sign _____ Deadweight 294892 tonnes Year built _____
 Draught For'd 21 m Draught Aft 21 m Displacement 336615 tonnes

Ship's Particulars
 Length overall 333 m Anchor chain shackles: Port _____, Starboard _____
 Breadth 60 m Stern Anchor shackles: _____
 Bulbous bow _____ (1 shackle = _____ m / _____ fathoms)

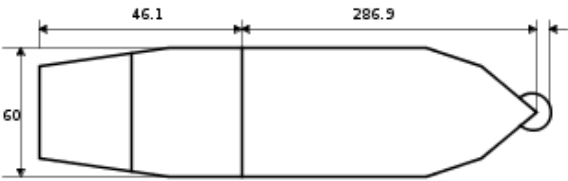
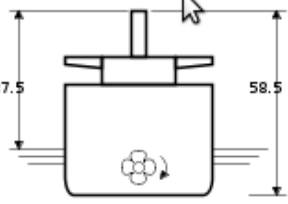
Engine type _____ Maximum Power 28418 kW 38109 hp
 Full Sea Speed (knots) 74 15.8

Manoeuvring engine order		RPM/Pitch	Speed (knots)
Full ahead	60		12.8
Half ahead	48		10.2
Slow ahead	37		7.9
Dead slow ahead	26		5.5
Dead slow astern	37	Time limit astern _____ min	
Slow astern	0	Full ahead to full astern _____ s	
Half astern	0	Max. No. of consec. starts _____	
Full astern	0	Minimum RPM 26, 5.5 knots	
		Astern power _____ % ahead	

Steering Particulars
 Type of rudder _____ Maximum angle 35 deg
 Hard-over to hard-over 23.3 s
 Rudder angle for neutral effect _____ deg

Pilot card VLCC

Ship Generation Tool v2.0

File

Parameters Results **Pilot Card**

PILOT CARD

Ships name **bulkcarrier_292x45x18_5-0.os** Date 12/02/16
 Call sign _____ Deadweight 179900 tonnes Year built _____
 Draught For'd 18.5 m Draught Aft 18.5 m Displacement 202636 tonnes

Ship's Particulars
 Length overall 292 m Anchor chain shackles: Port _____, Starboard _____
 Breadth 45 m Stern Anchor shackles: _____
 Bulbous bow _____ (1 shackle = _____ m / _____ fathoms)

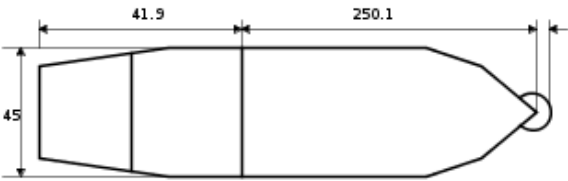
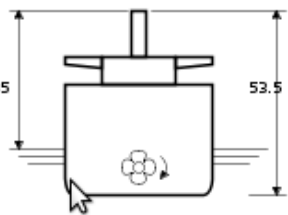
Engine type _____ Maximum Power 18602 kW 24946 hp
 Full Sea Speed (knots) 86 15.5

Manoeuvring engine order	RPM/Pitch	Speed (knots)
Full ahead	76	13.7
Half ahead	65	11.7
Slow ahead	46	8.2
Dead slow ahead	30	5.5
Dead slow astern	-30	Time limit astern _____ min
Slow astern	-46	Full ahead to full astern _____ s
Half astern	-65	Max. No. of consec. starts _____
Full astern	-76	Minimum RPM 30, 5.5 knots Astern power _____ % ahead

Steering Particulars
 Type of rudder _____ Maximum angle 35 deg
 Hard-over to hard-over 23.3 s
 Rudder angle for neutral effect _____ deg

Pilot card Cape Size

APPENDIX C Track and data plots of real-time simulations

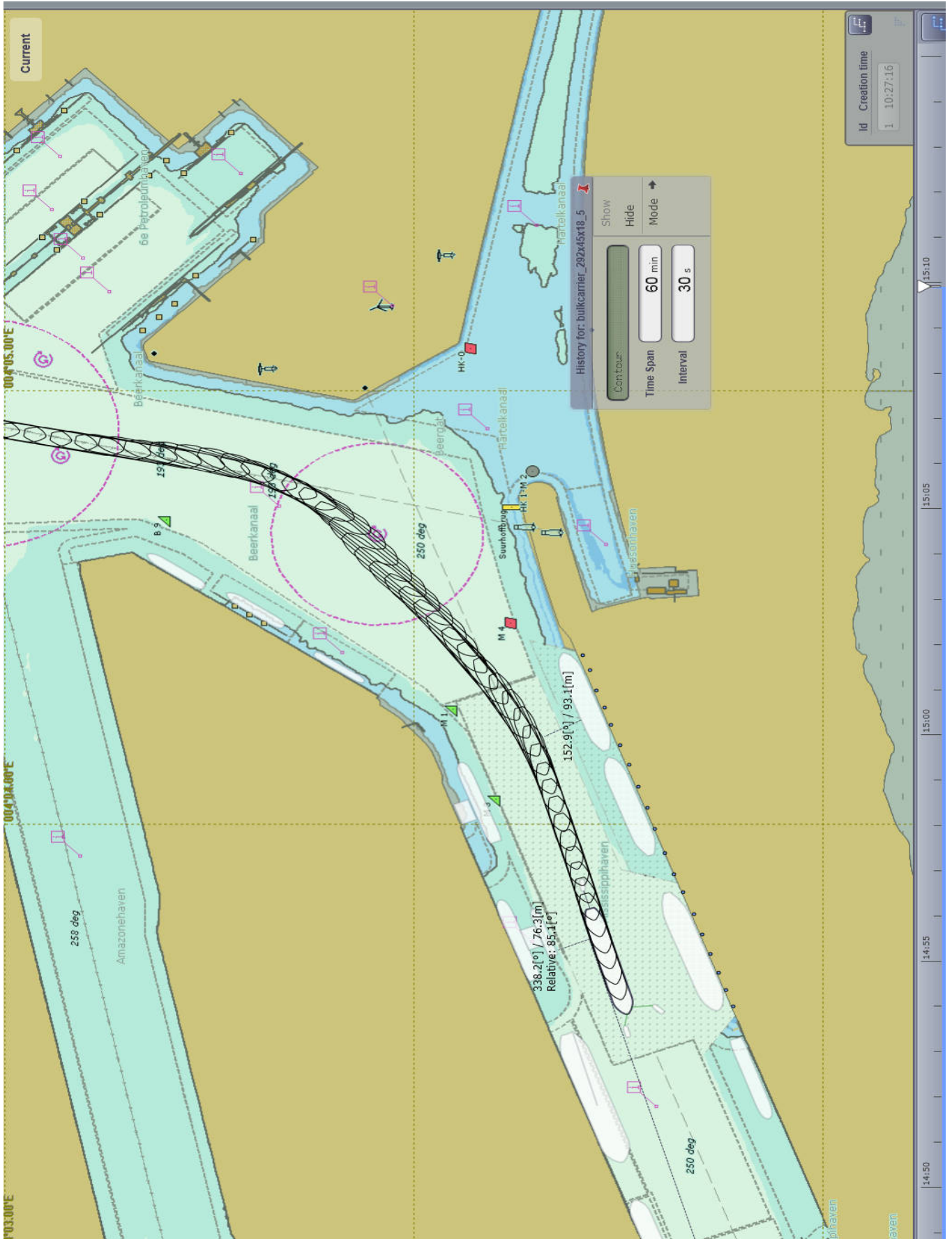

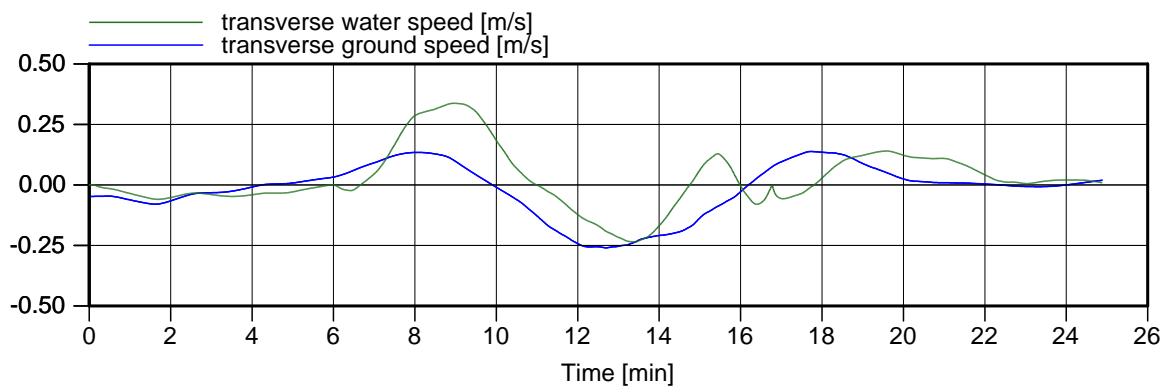
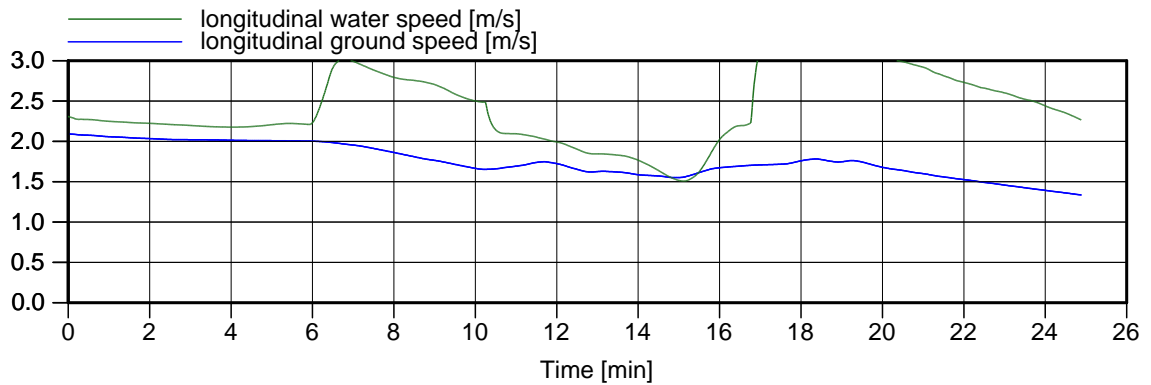
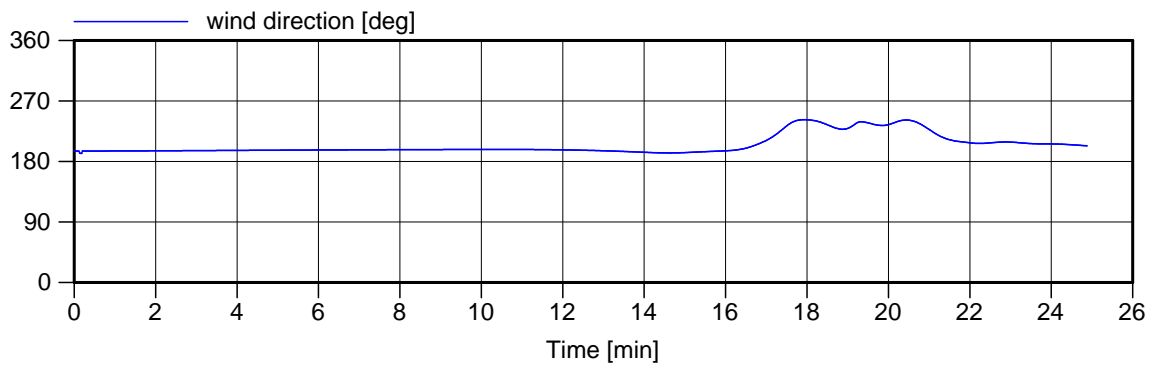
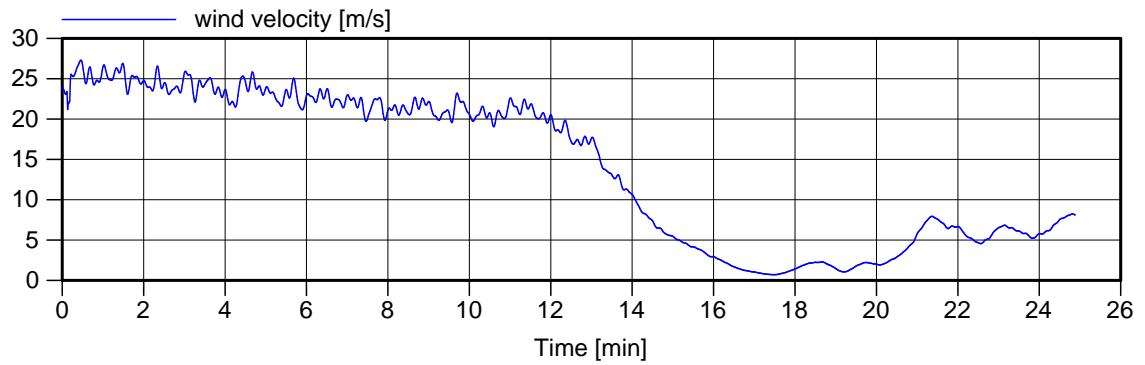

Environment

Run: 16-3 Arr

Ship: Capesize 292x45x18.5

Wind: SSW 15.5 m/s

Current: Ebb 1 kts

Figure: 3.b

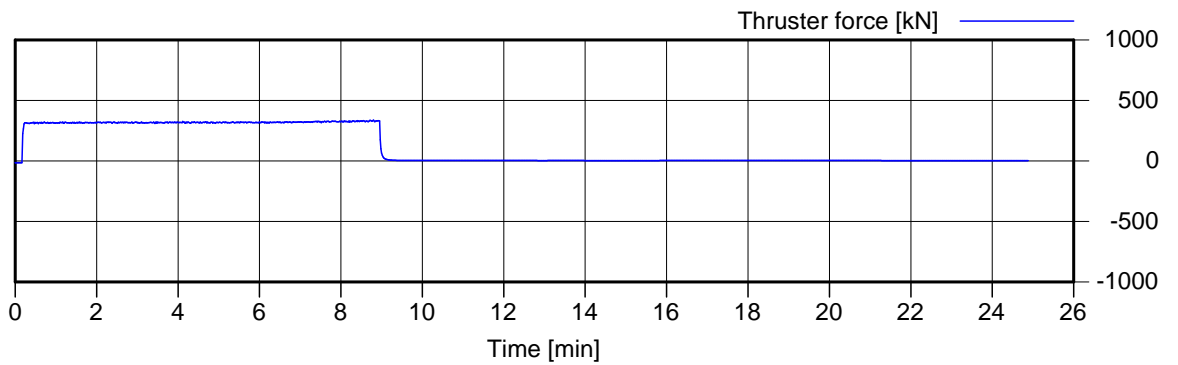
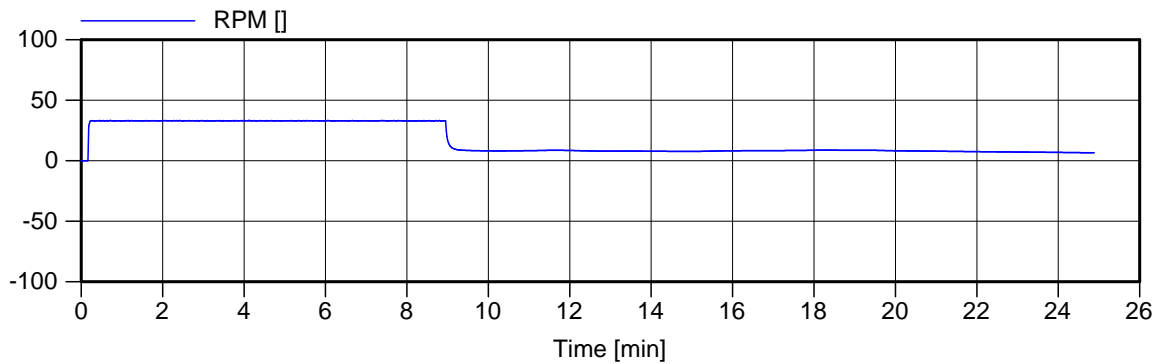
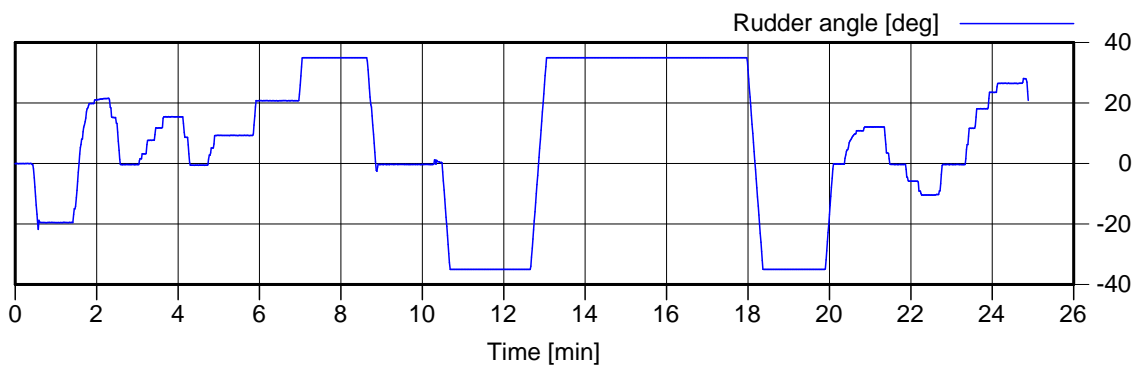
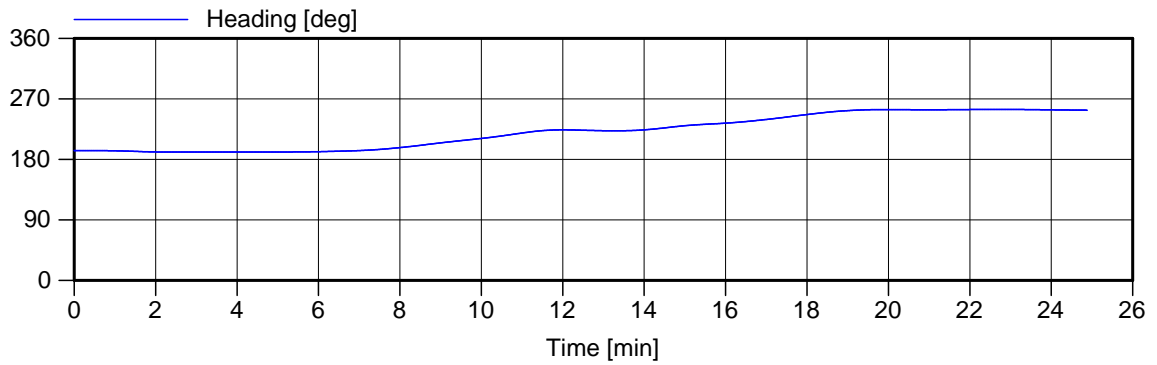

Ship data 1

Run: 16-3 Arr

Ship: Capesize 292x45x18.5

Wind: SSW 15.5 m/s

Current: Ebb 1 kts

Figure: 3.c

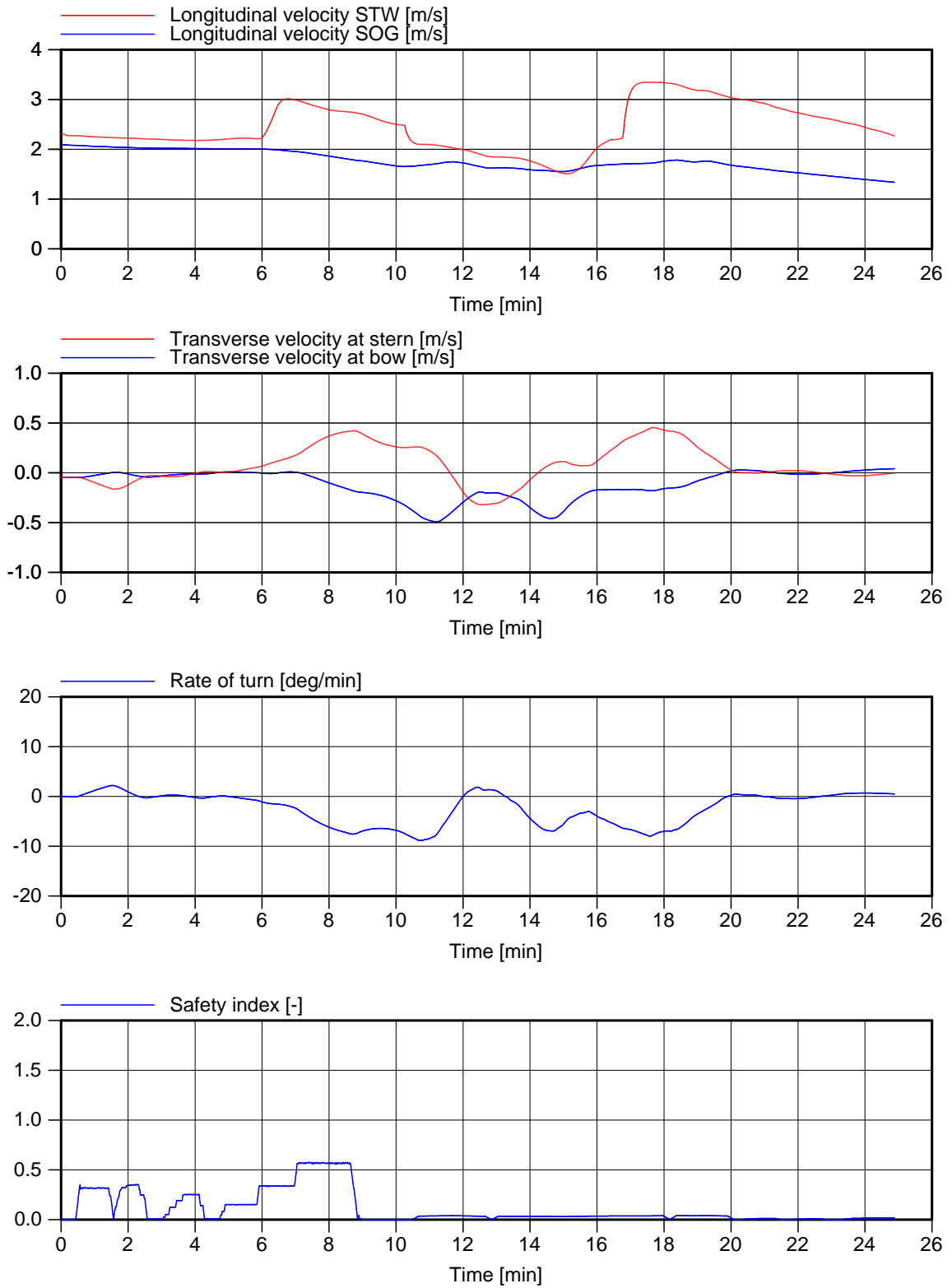

Ship data 2

Ship: Capesize 292x45x18.5

Current: Ebb 1 kts

Run: 16-3 Arr

Wind: SSW 15.5 m/s

Figure: 3.d

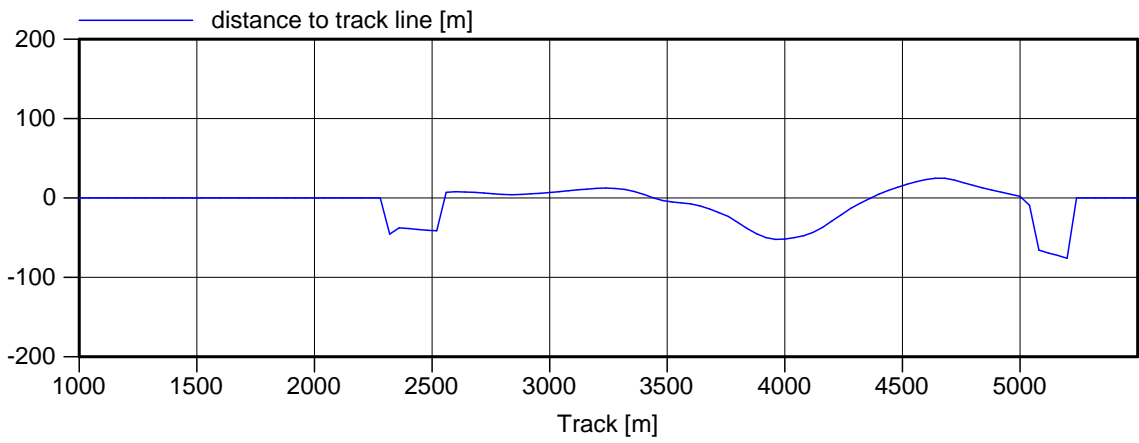
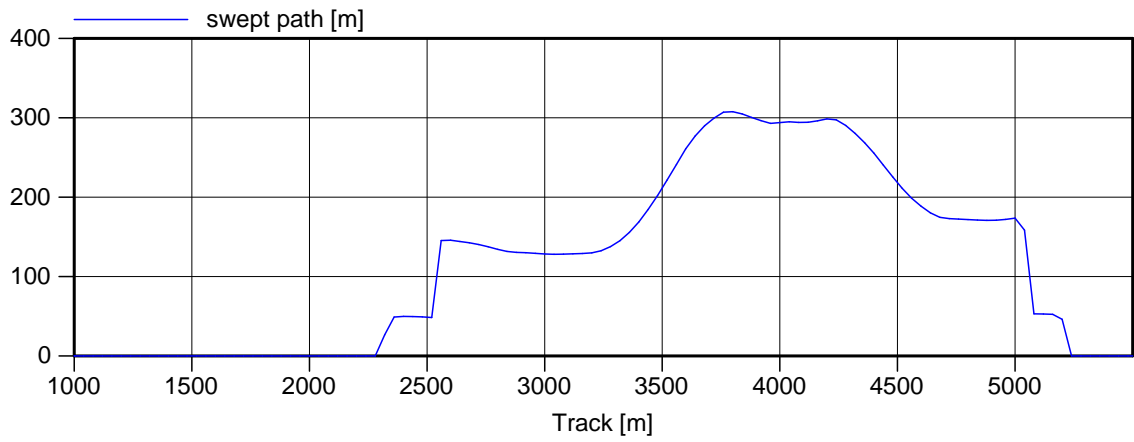

Space used	Run: 16-3 Arr
Ship: Capesize 292x45x18.5	Wind: SSW 15.5 m/s
Current: Ebb 1 kts	Figure: 3.e

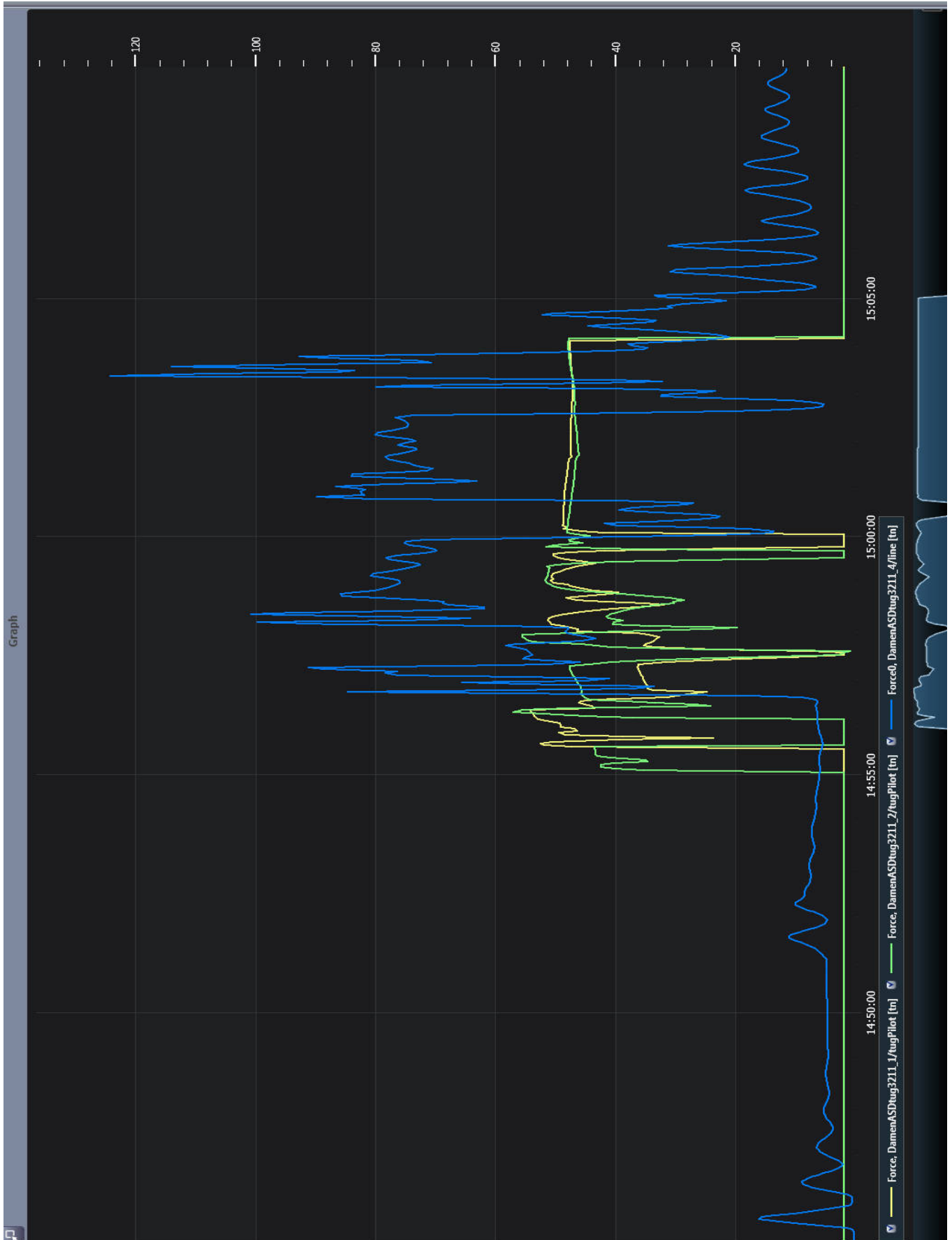

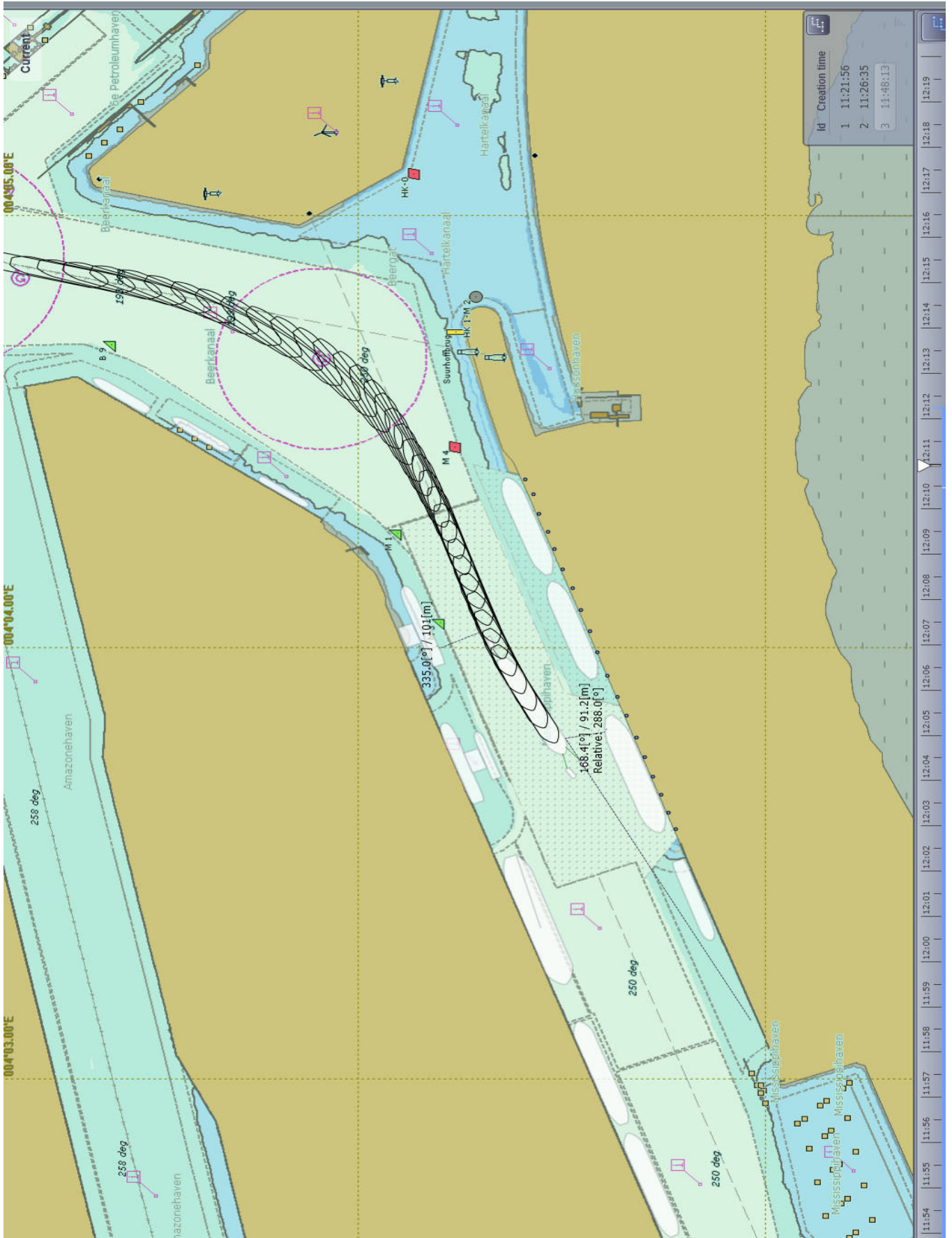

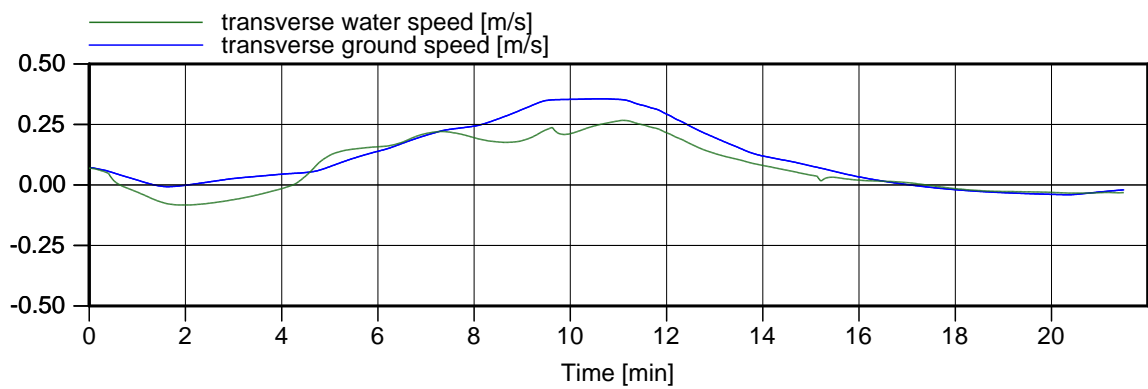
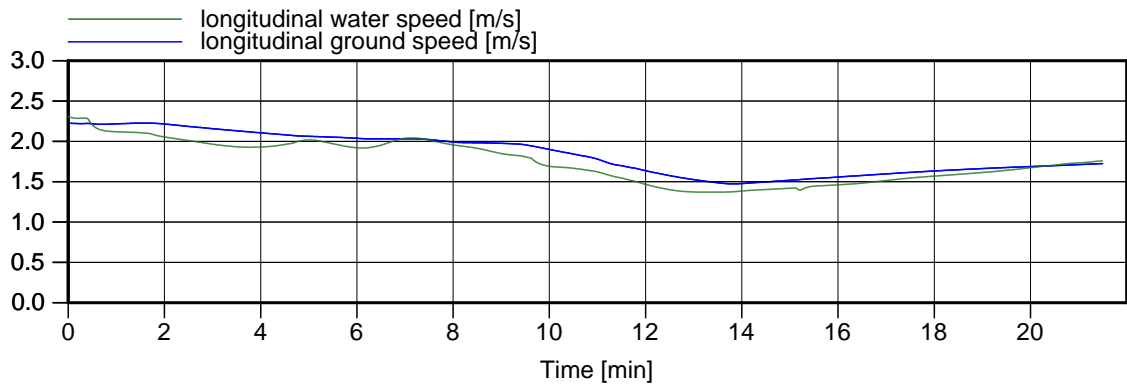
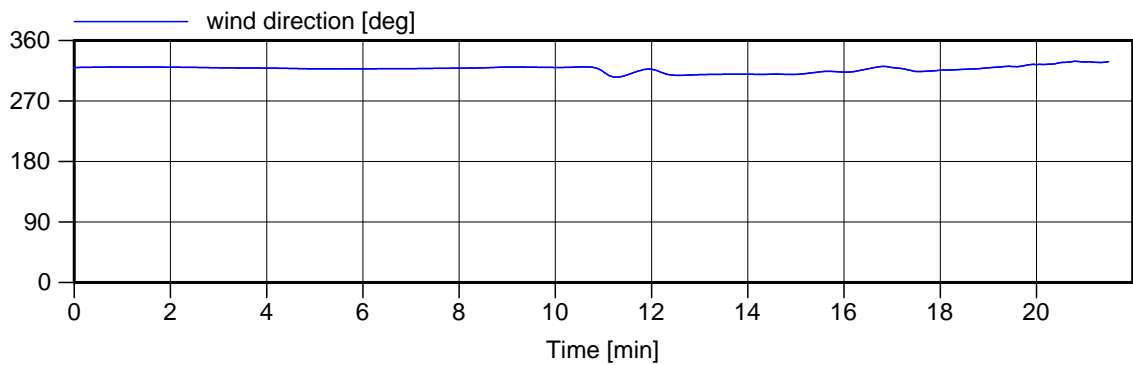
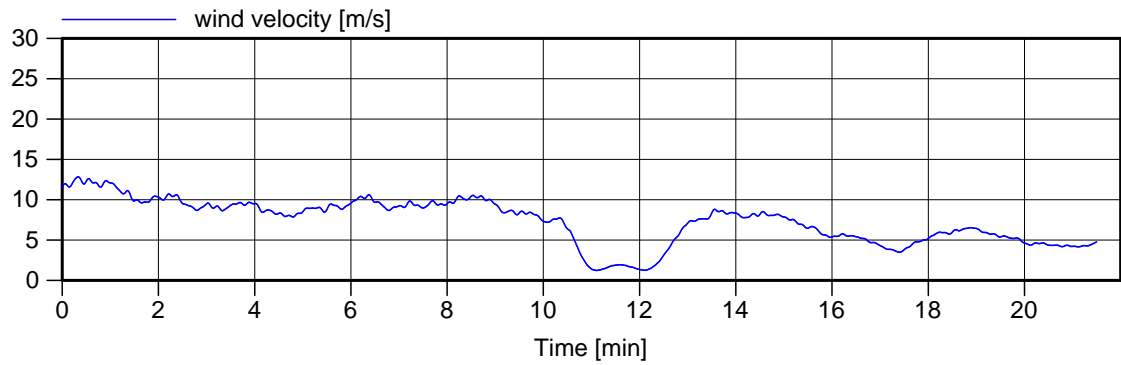

Environment

Run: 16-4 Arr

Ship: Capesize 292x45x18.5

Wind: NW 15.5 m/s

Current: Flood 1 kts

Figure: 4.b

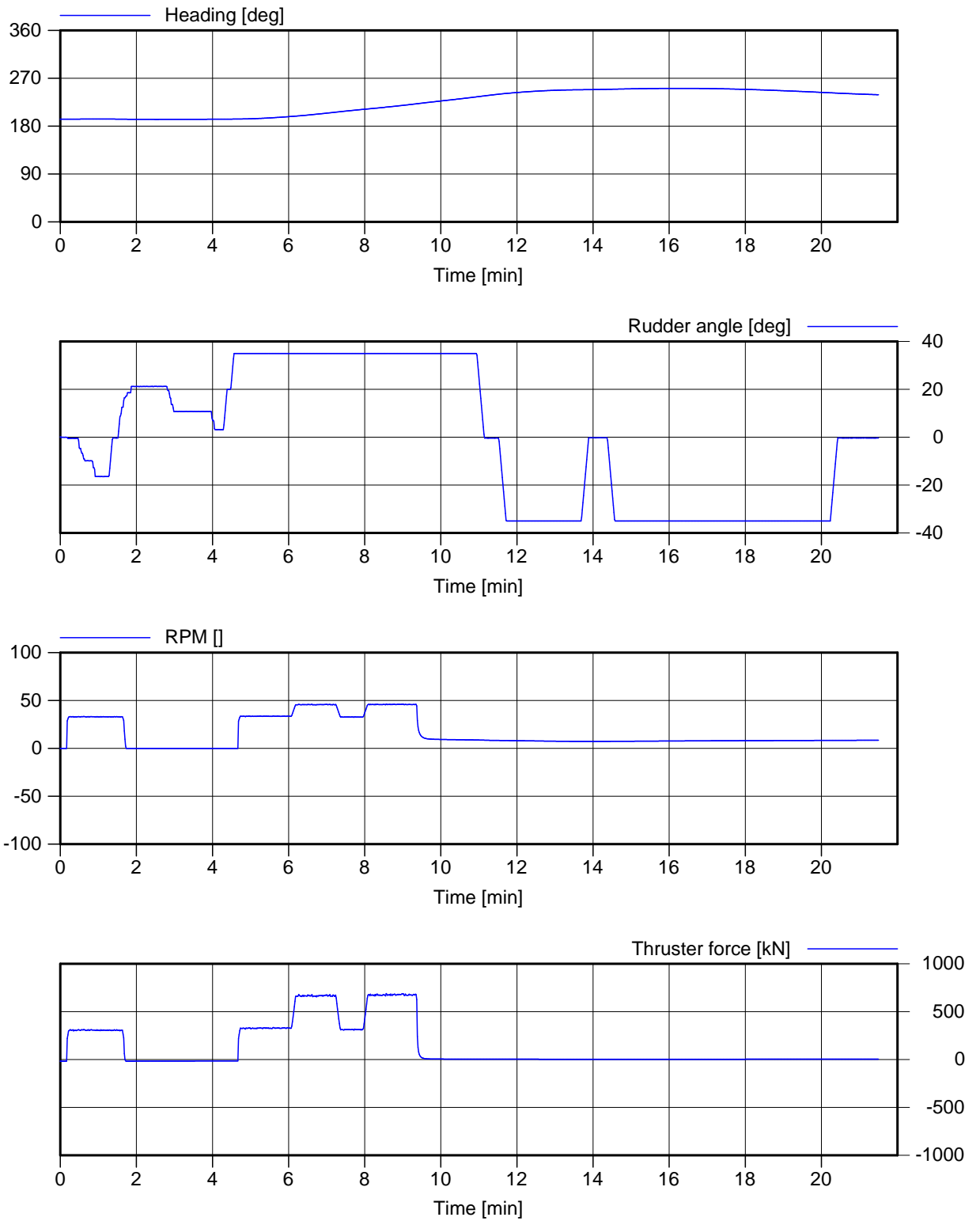

Ship data 1

Ship: Capesize 292x45x18.5

Current: Flood 1 kts

Run: 16-4 Arr

Wind: NW 15.5 m/s

Figure: 4.c

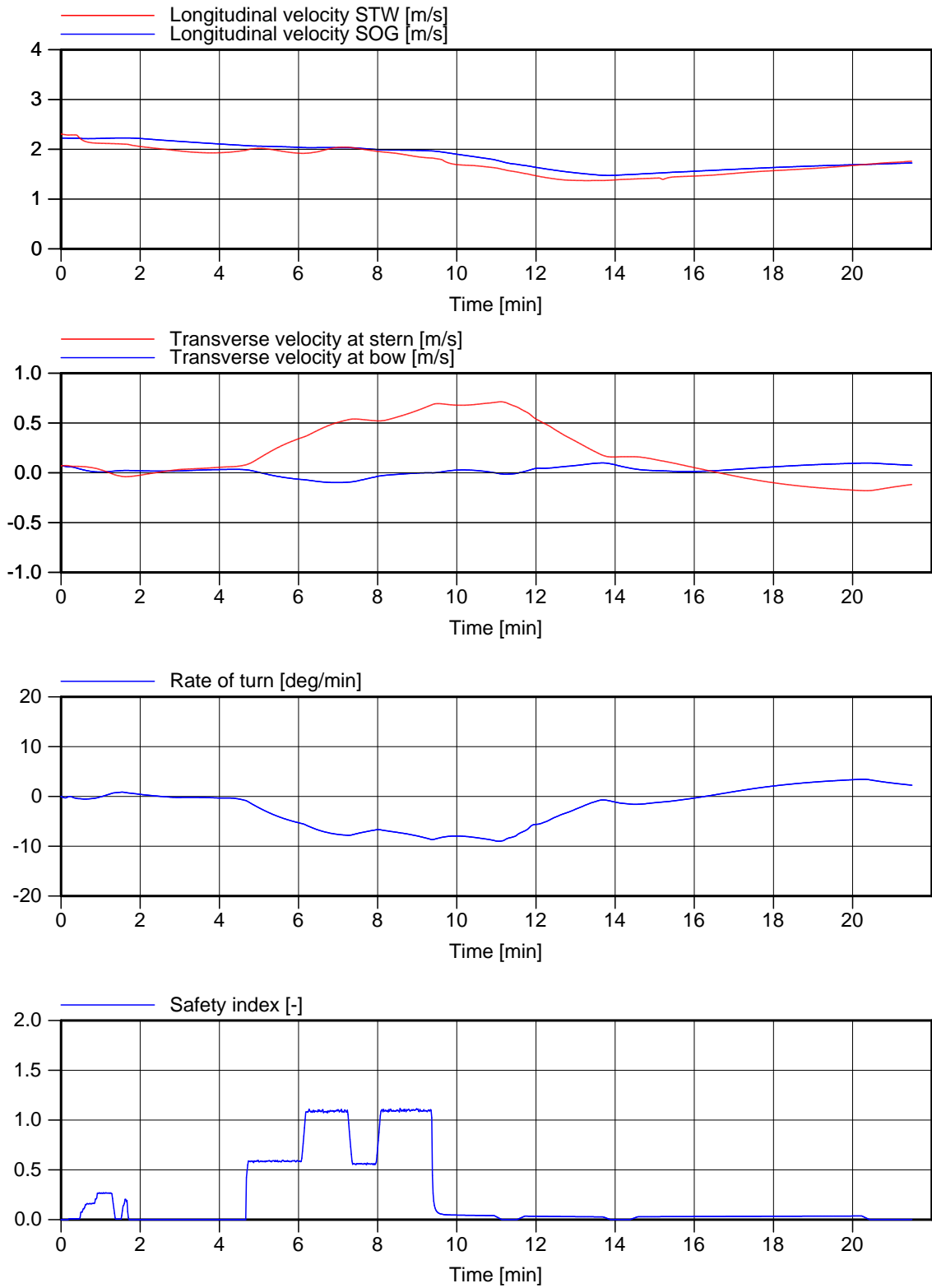

Ship data 2

Ship: Capesize 292x45x18.5

Current: Flood 1 kts

Run: 16-4 Arr

Wind: NW 15.5 m/s

Figure: 4.d

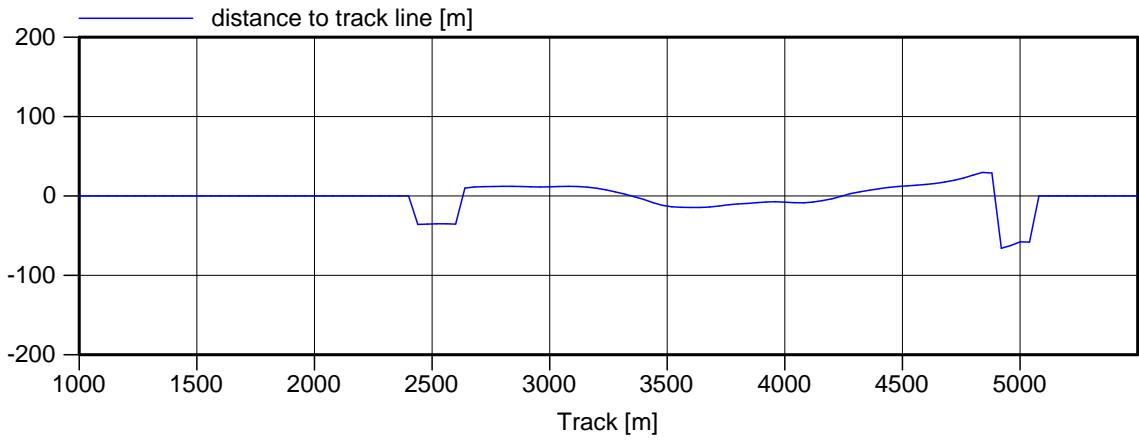
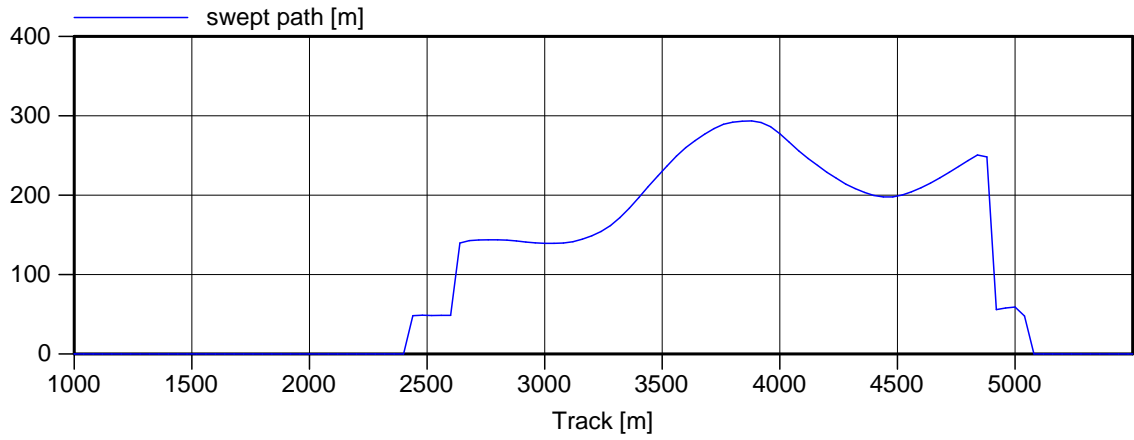

Space used	Run: 16-4 Arr
Ship: Capesize 292x45x18.5	Wind: NW 15.5 m/s
Current: Flood 1 kts	Figure: 4.e

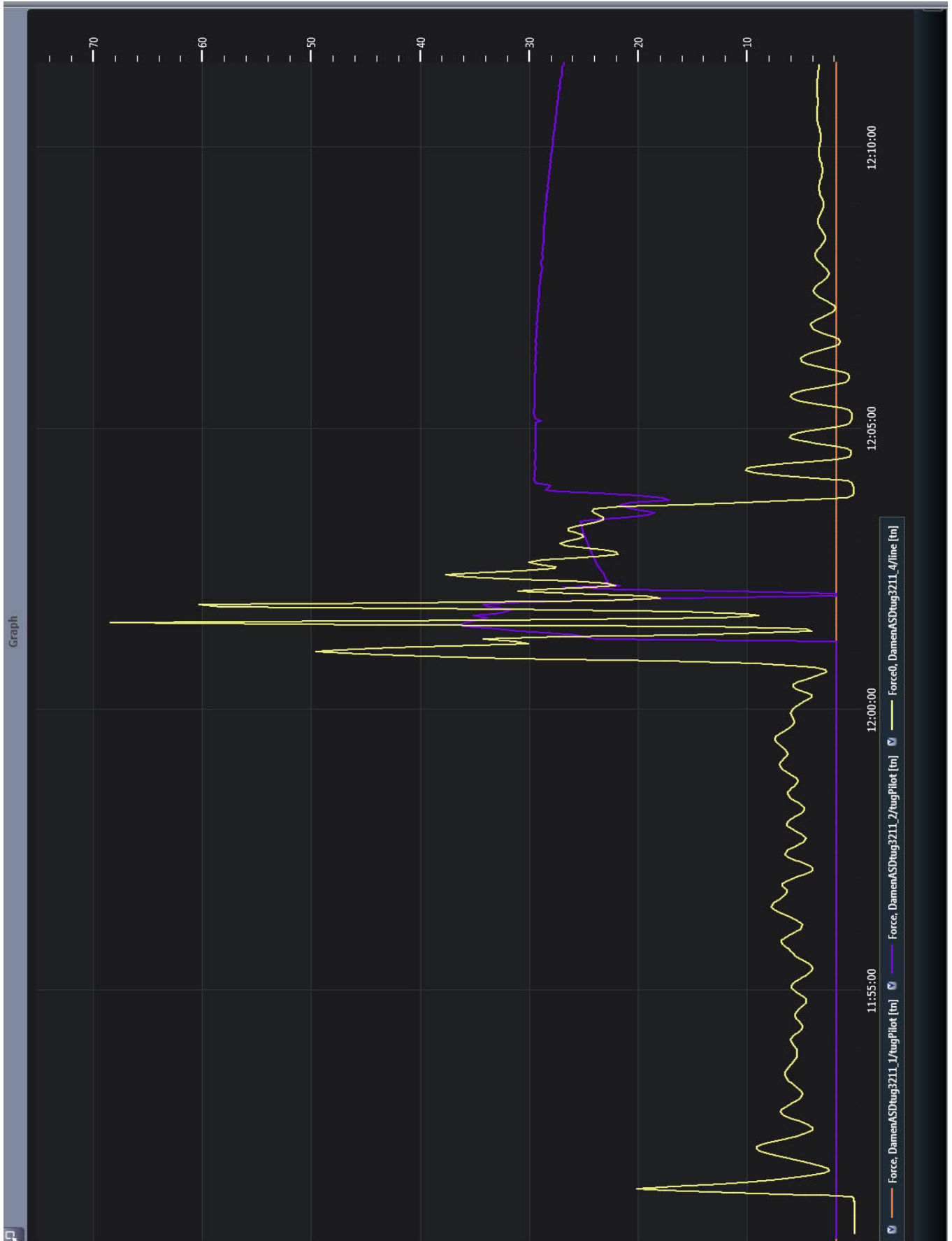

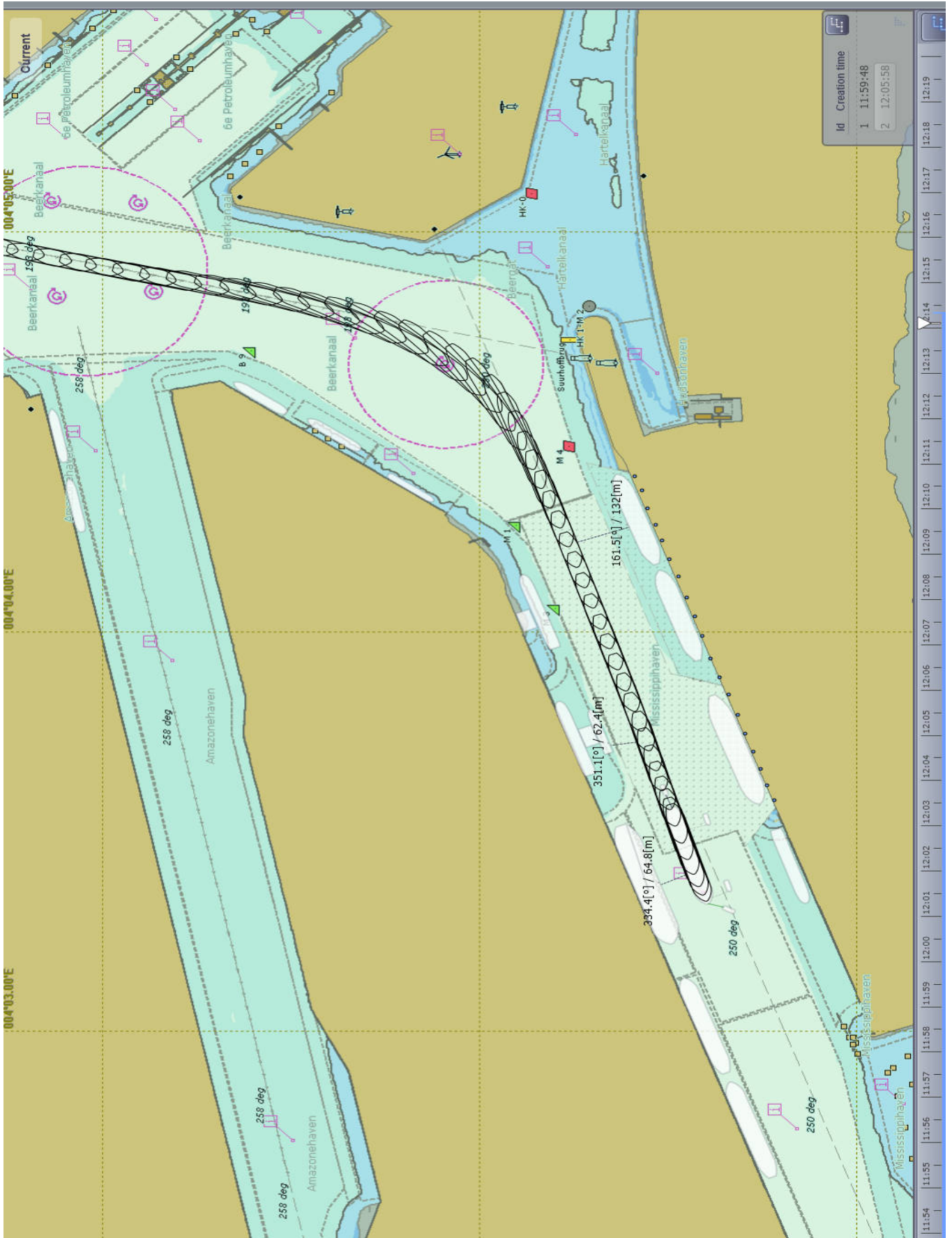

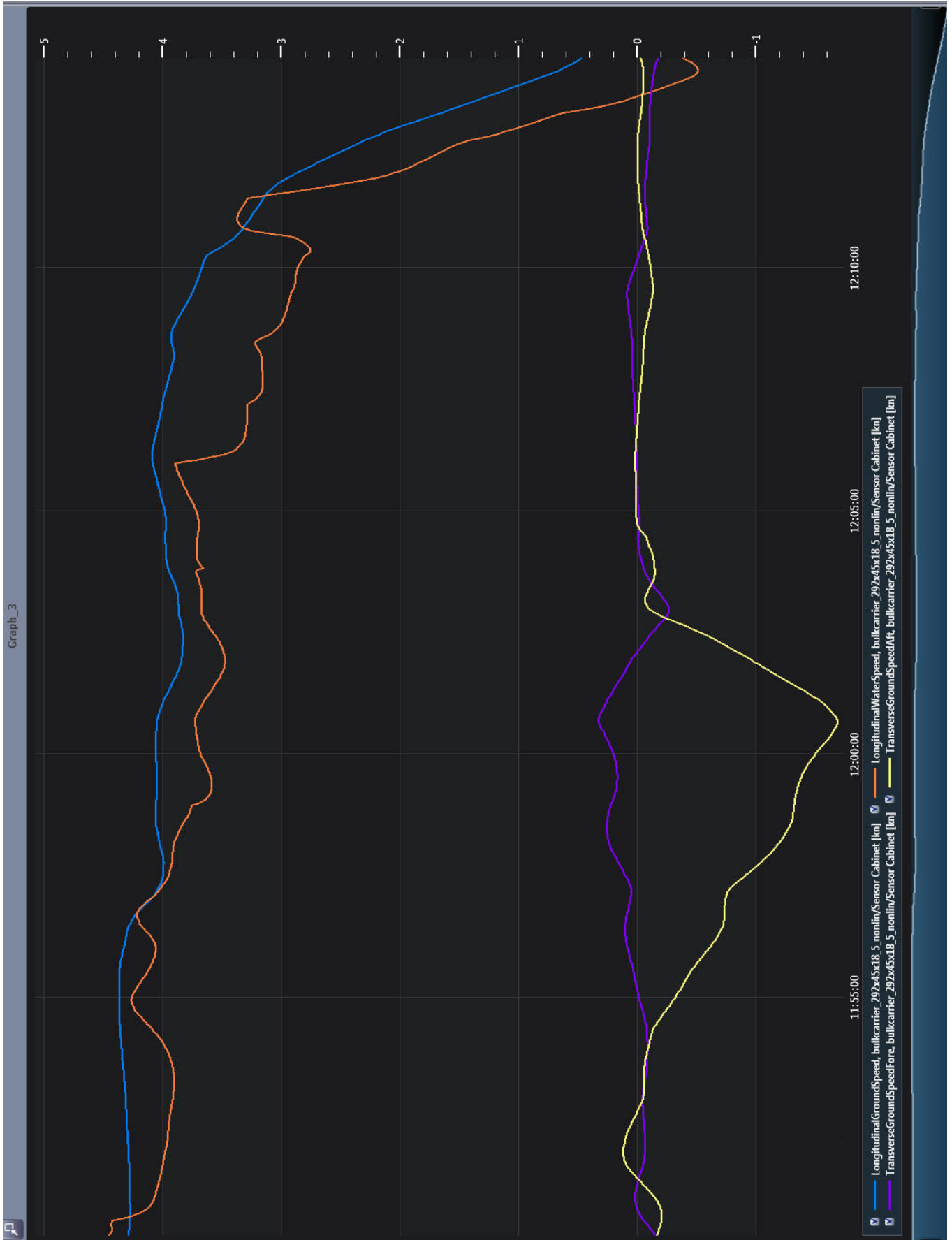

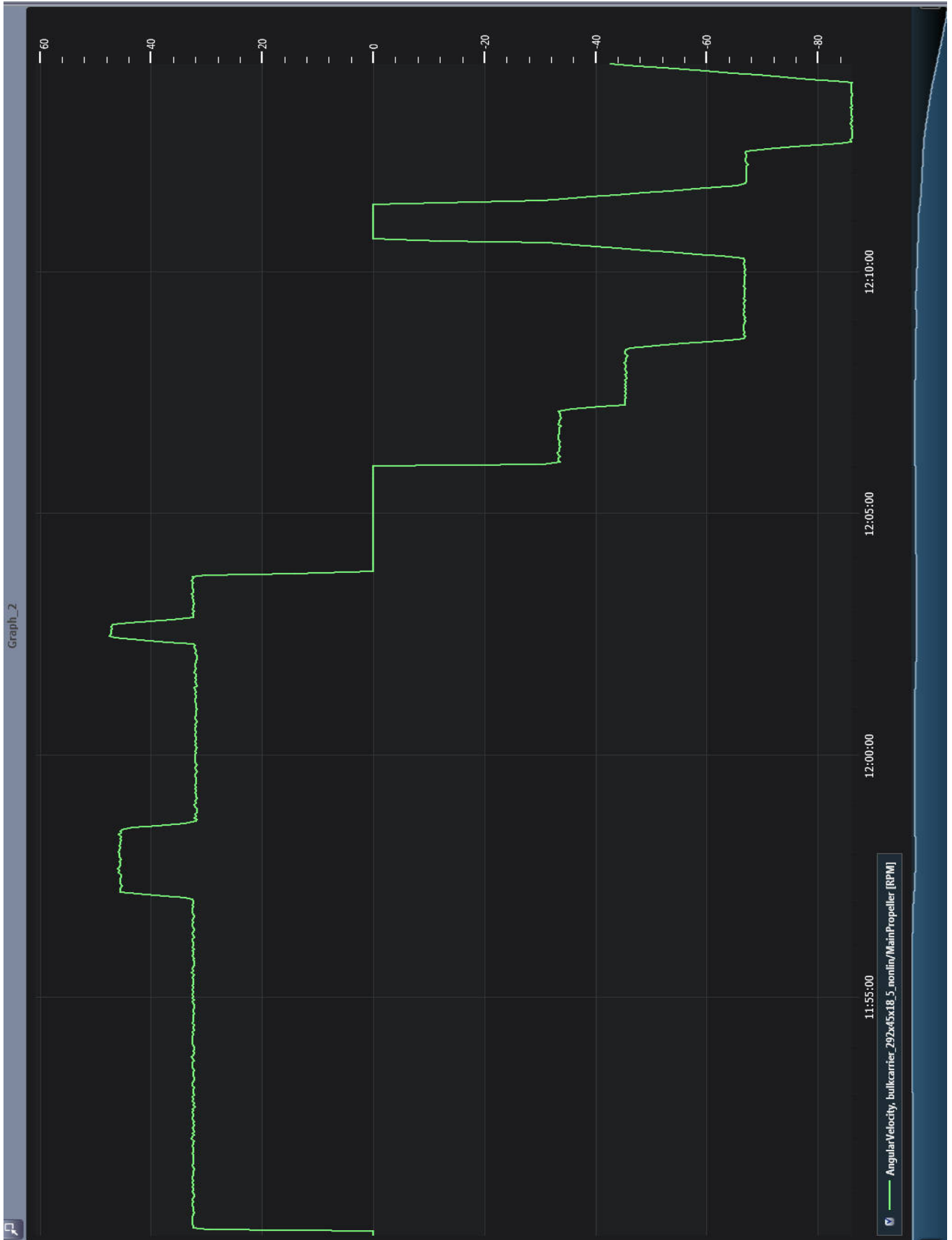

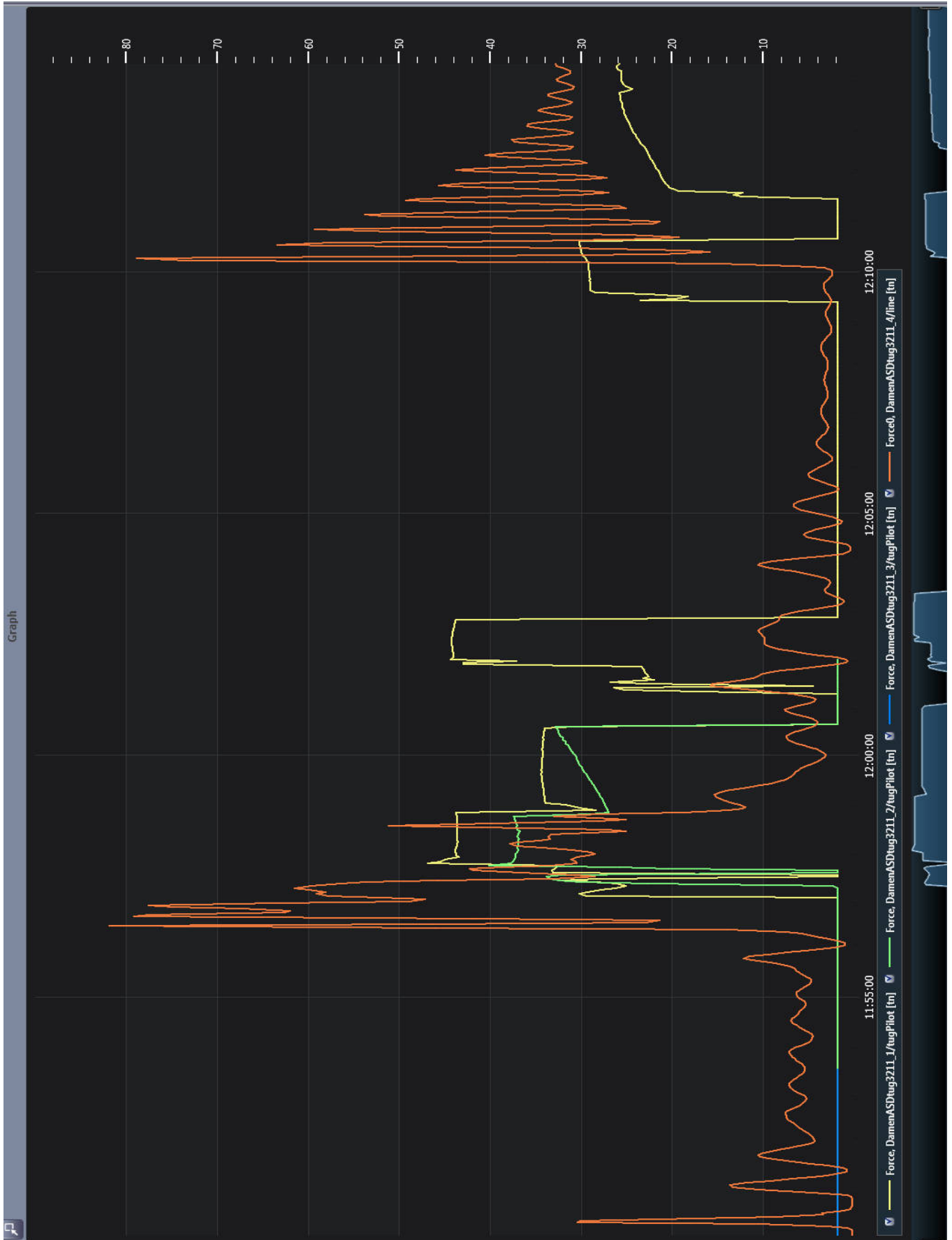

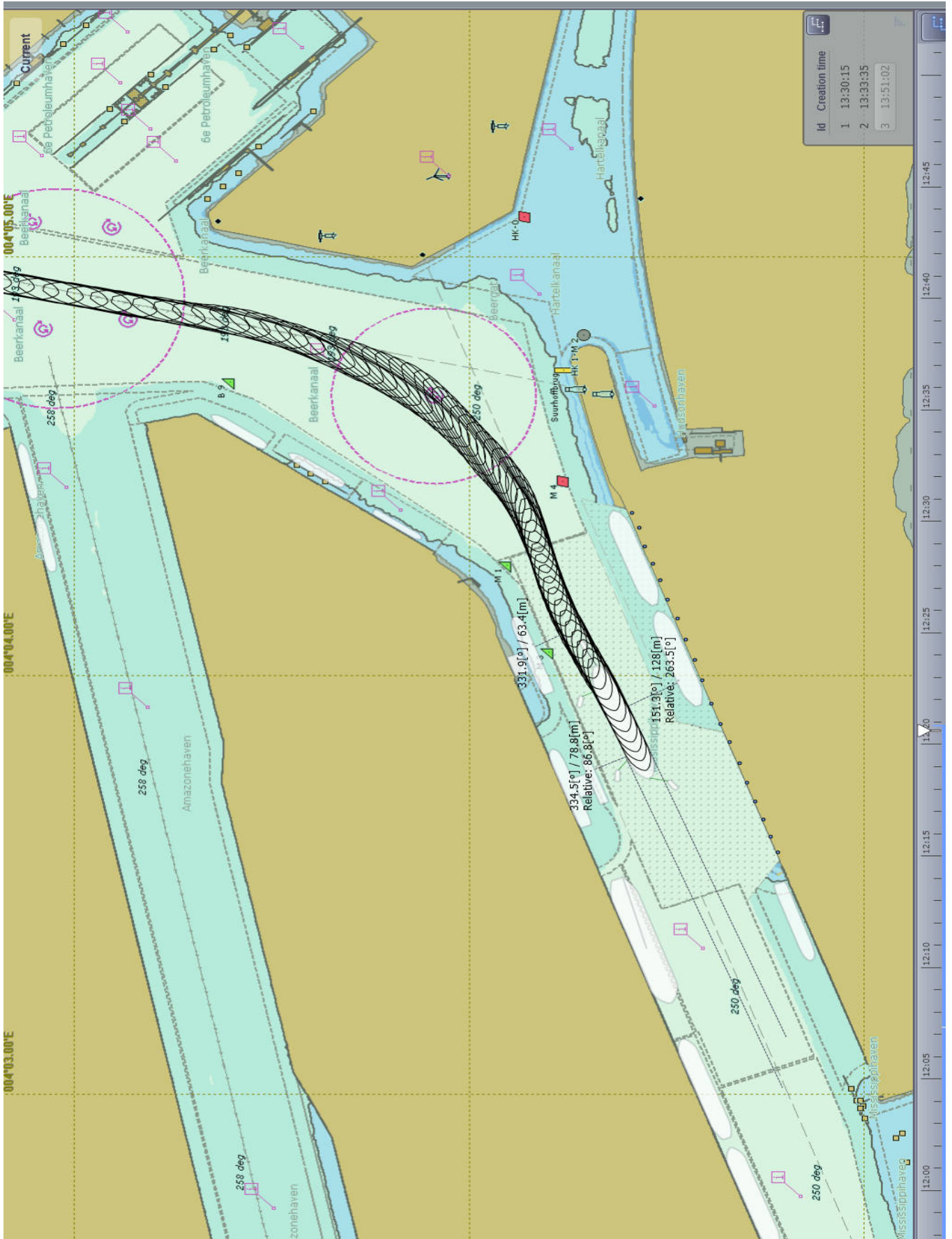

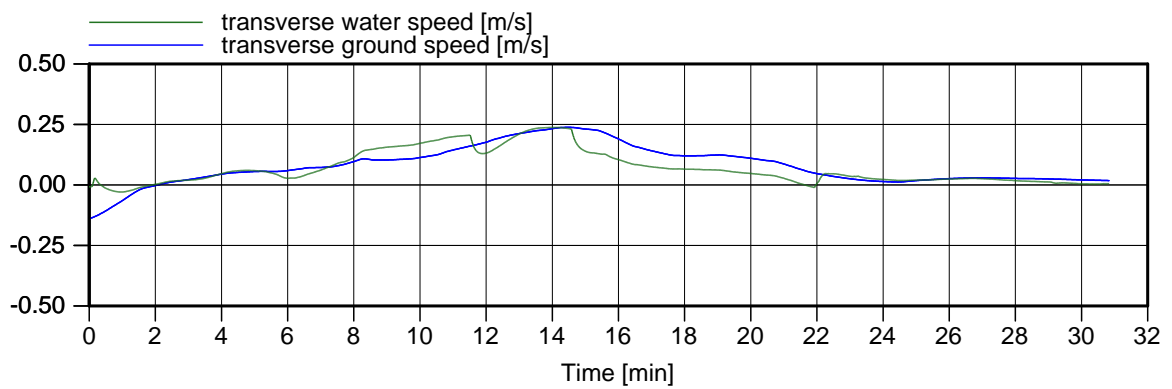
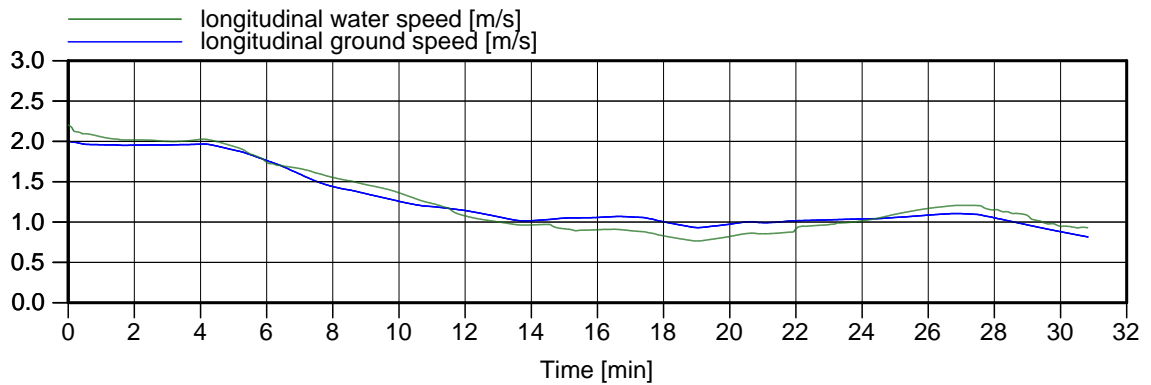
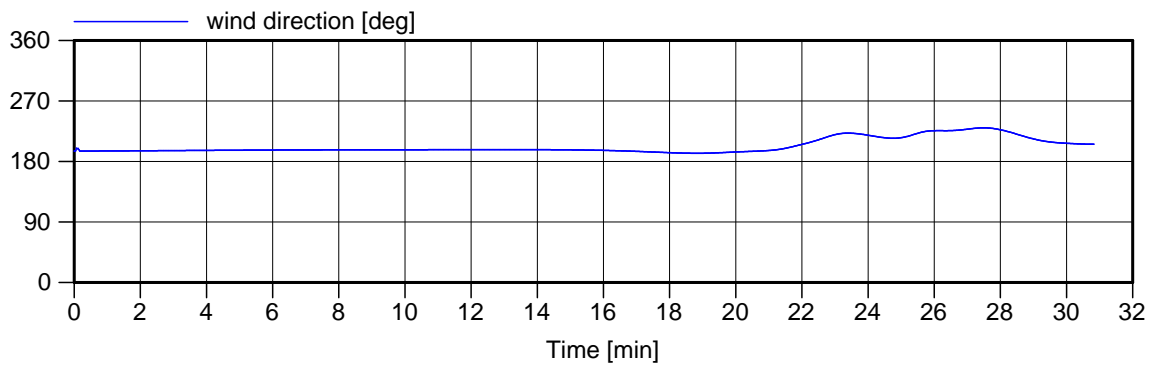
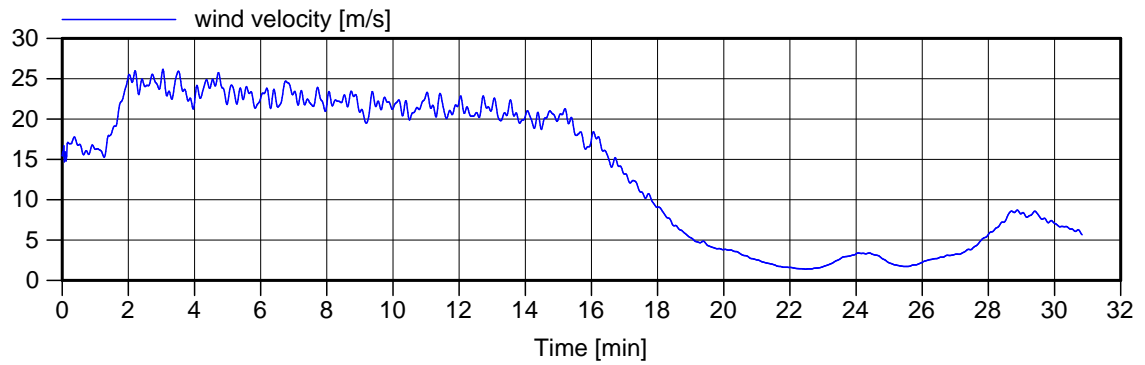

Environment

Run: 16-6 Arr

Ship: VLCC 332x58x21.0

Wind: SSW 15.5 m/s

Current: Flood 1 kts

Figure: 6.b

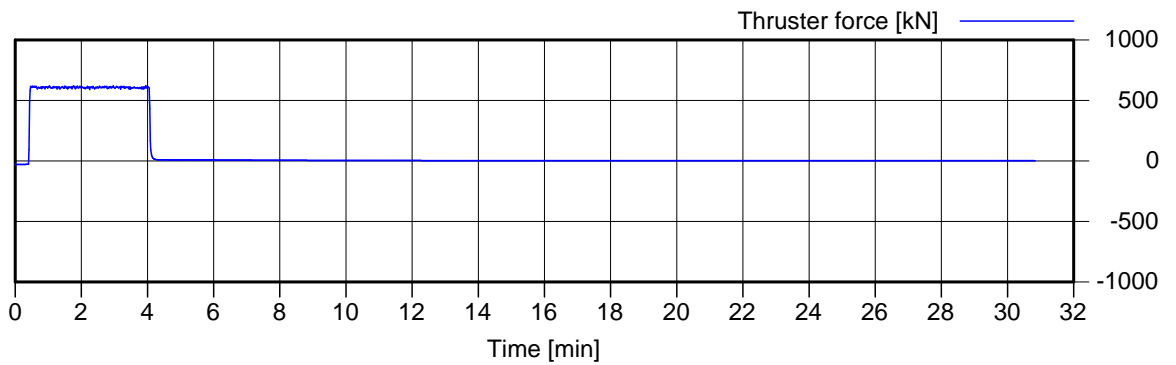
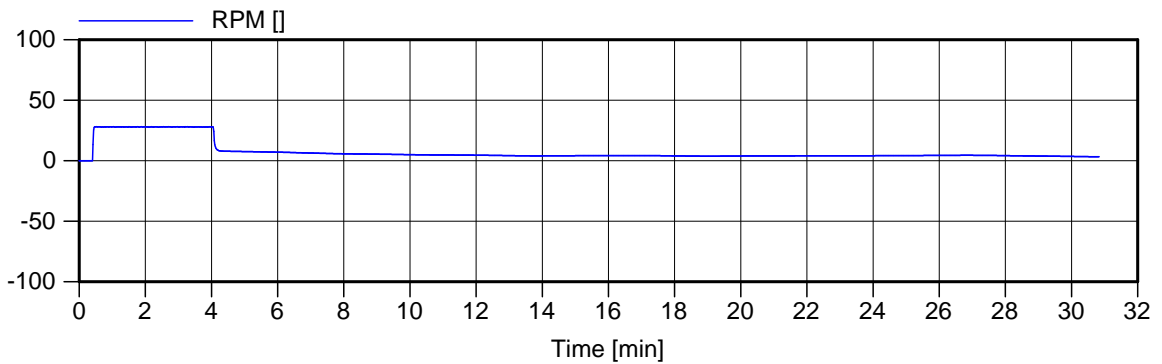
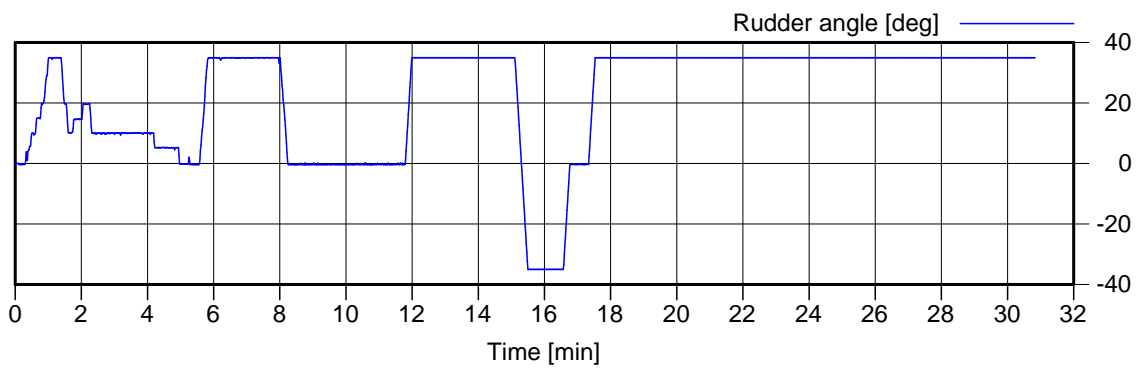
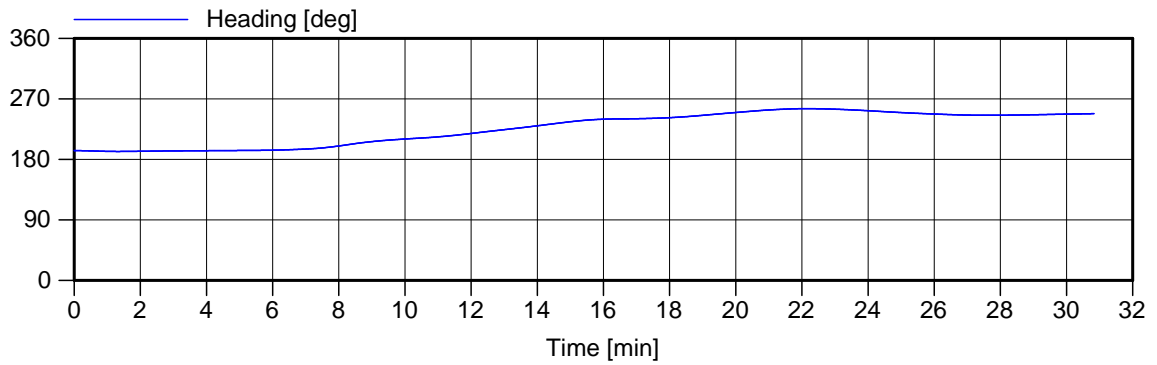

Ship data 1

Ship: VLCC 332x58x21.0

Current: Flood 1 kts

Run: 16-6 Arr

Wind: SSW 15.5 m/s

Figure: 6.c

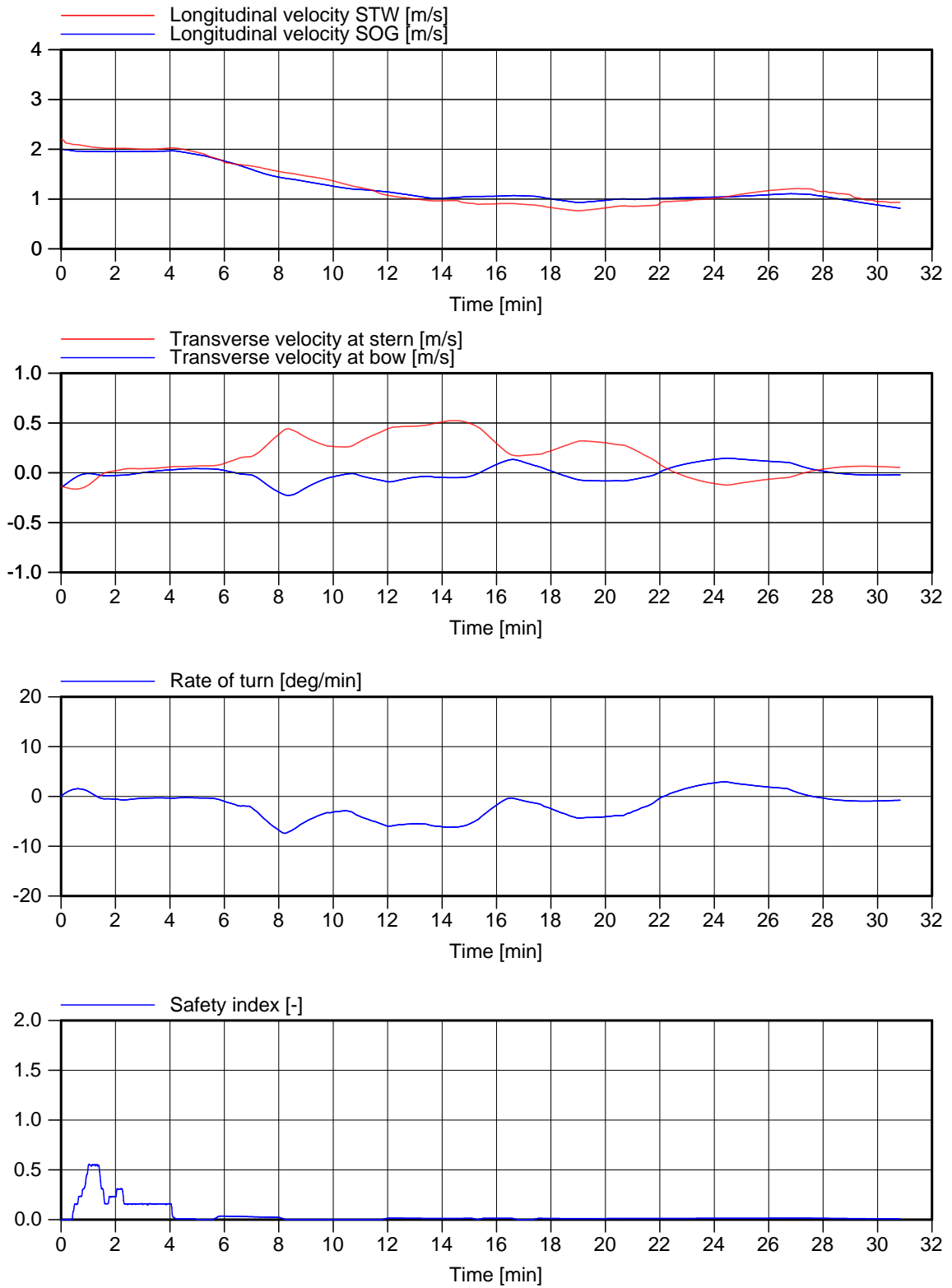

Ship data 2

Ship: VLCC 332x58x21.0

Current: Flood 1 kts

Run: 16-6 Arr

Wind: SSW 15.5 m/s

Figure: 6.d

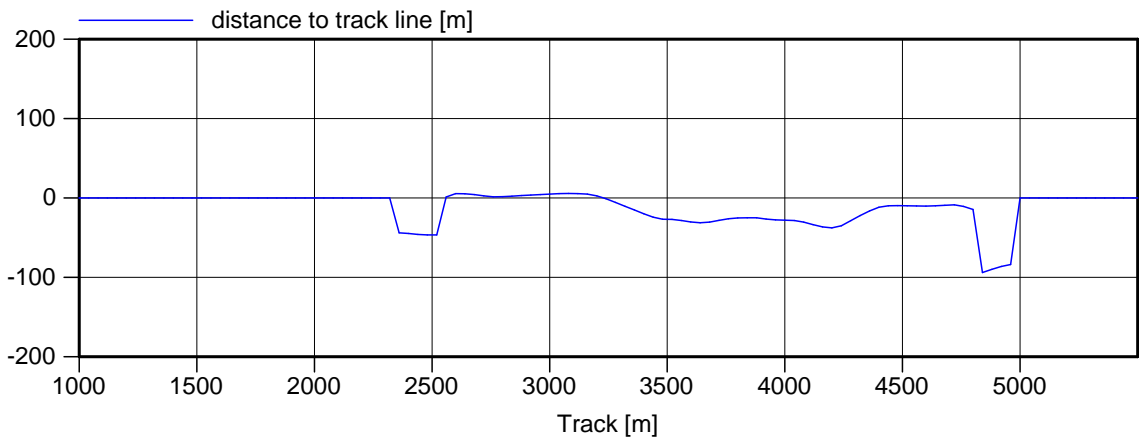
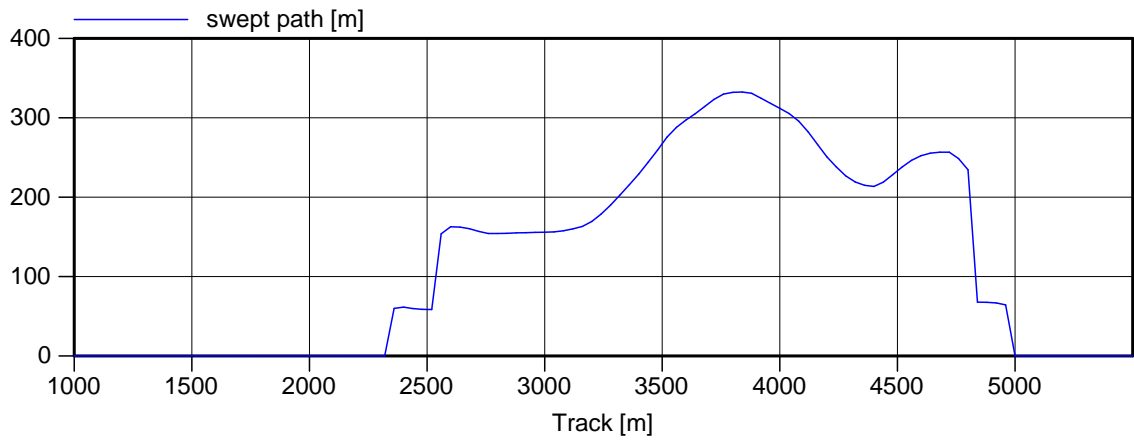

Space used	Run: 16-6 Arr
Ship: VLCC 332x58x21.0	Wind: SSW 15.5 m/s
Current: Flood 1 kts	Figure: 6.e

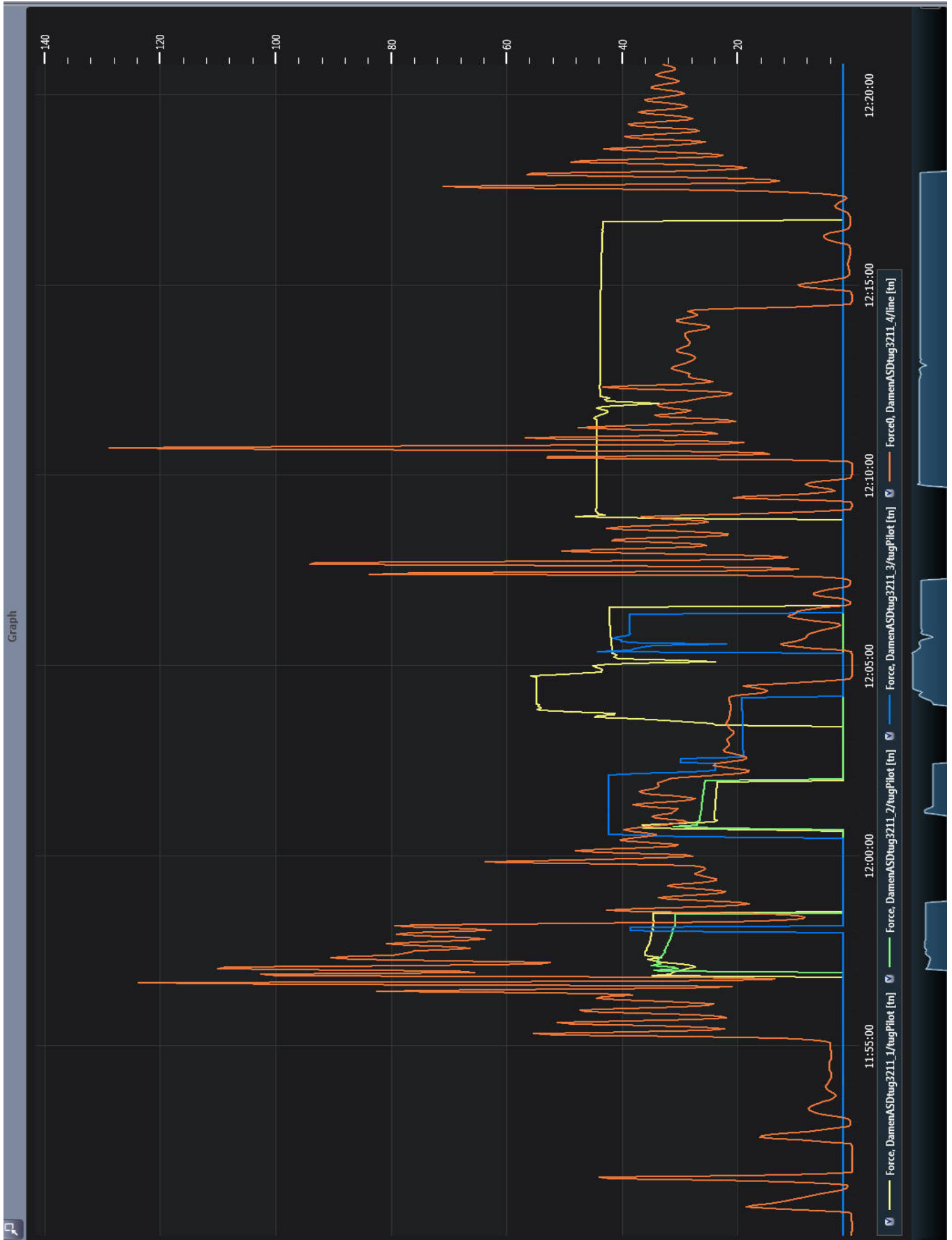

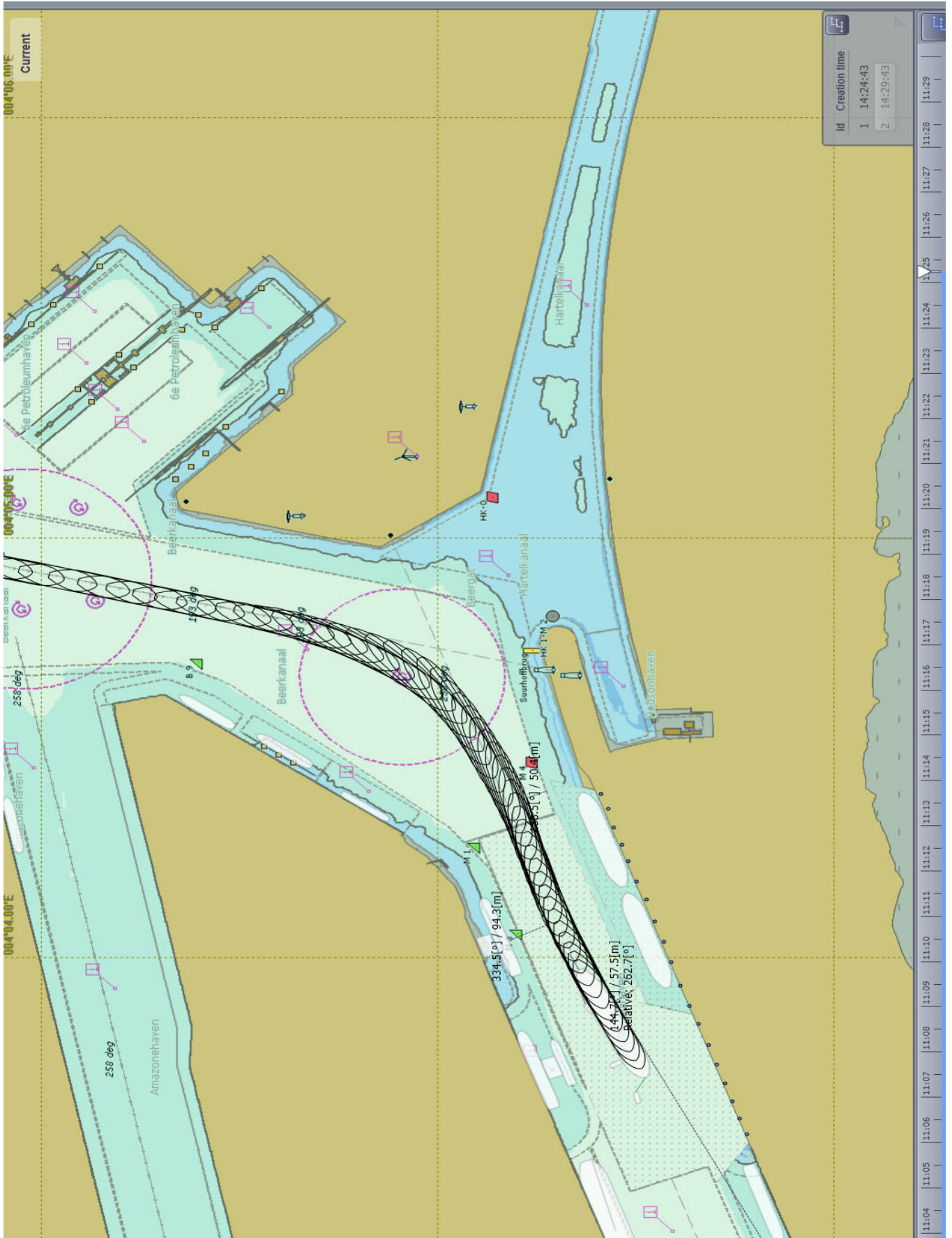

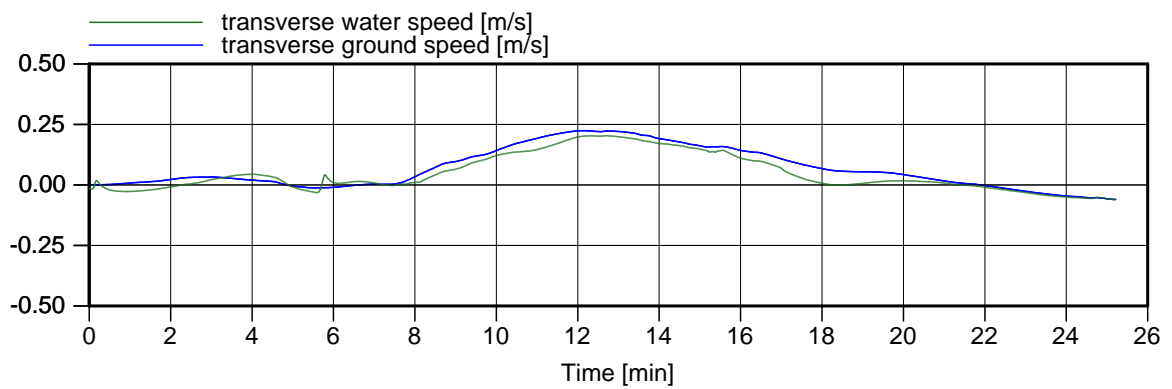
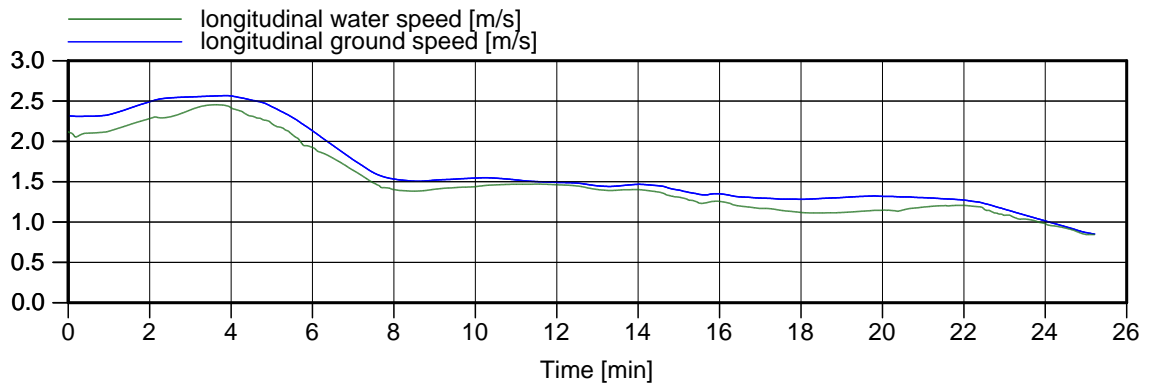
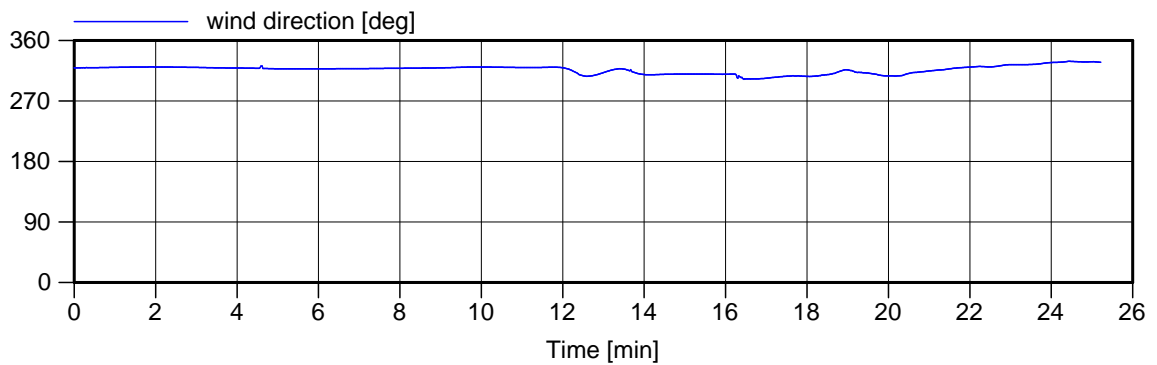
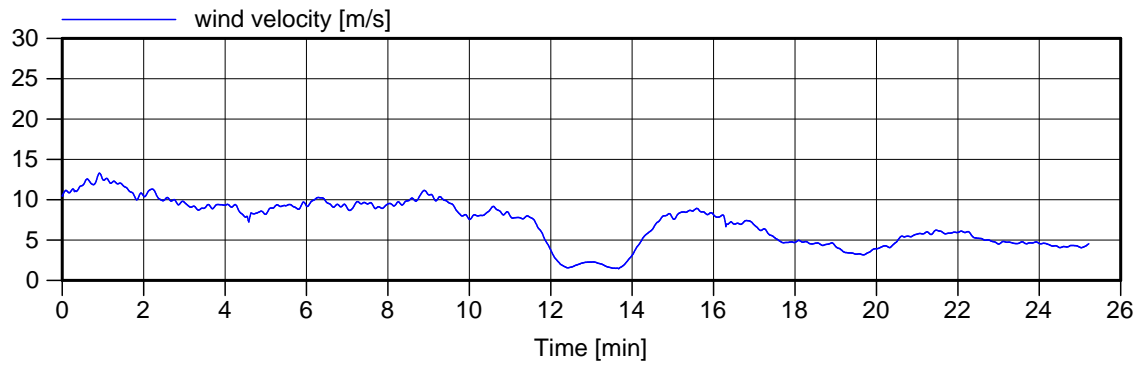

Environment

Run: 16-7 Arr

Ship: VLCC 332x58x21.0

Wind: NW 15.5 m/s

Current: Flood max

Figure: 7.b

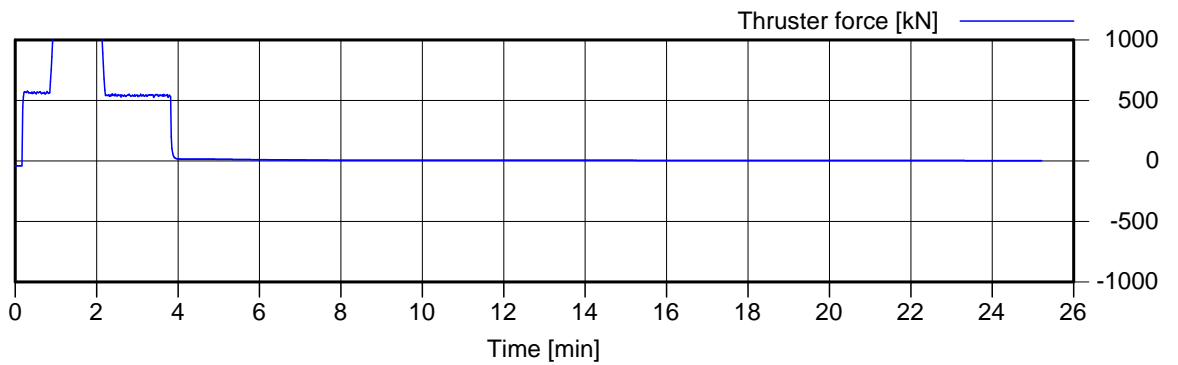
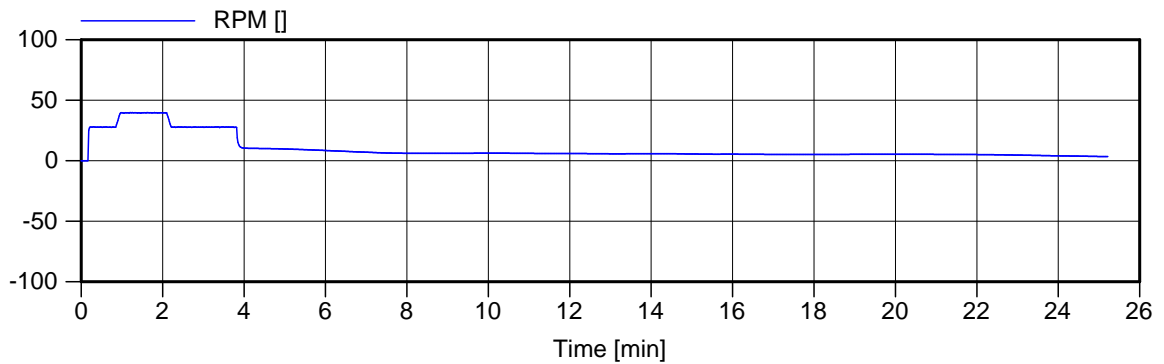
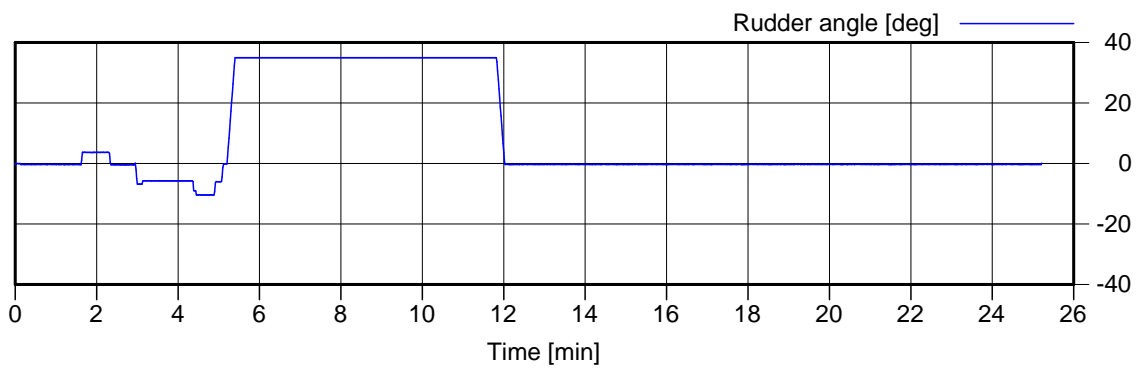
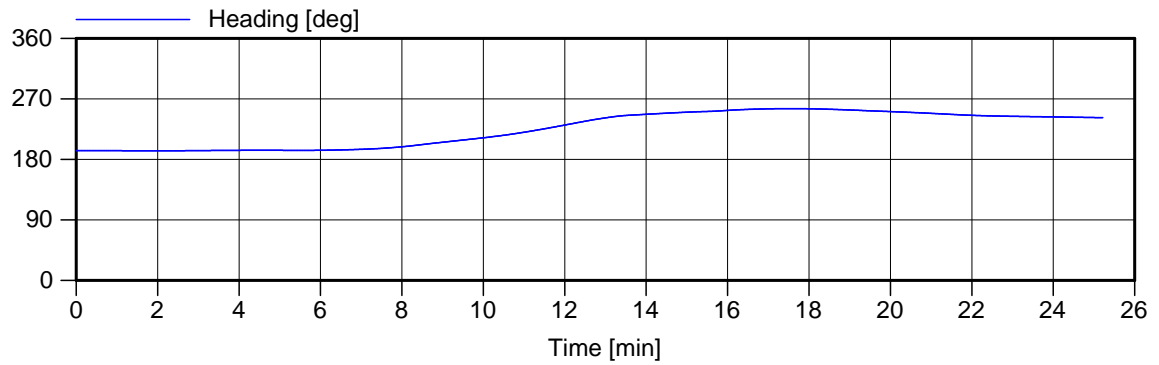

Ship data 1

Run: 16-7 Arr

Ship: VLCC 332x58x21.0

Wind: NW 15.5 m/s

Current: Flood max

Figure: 7.c

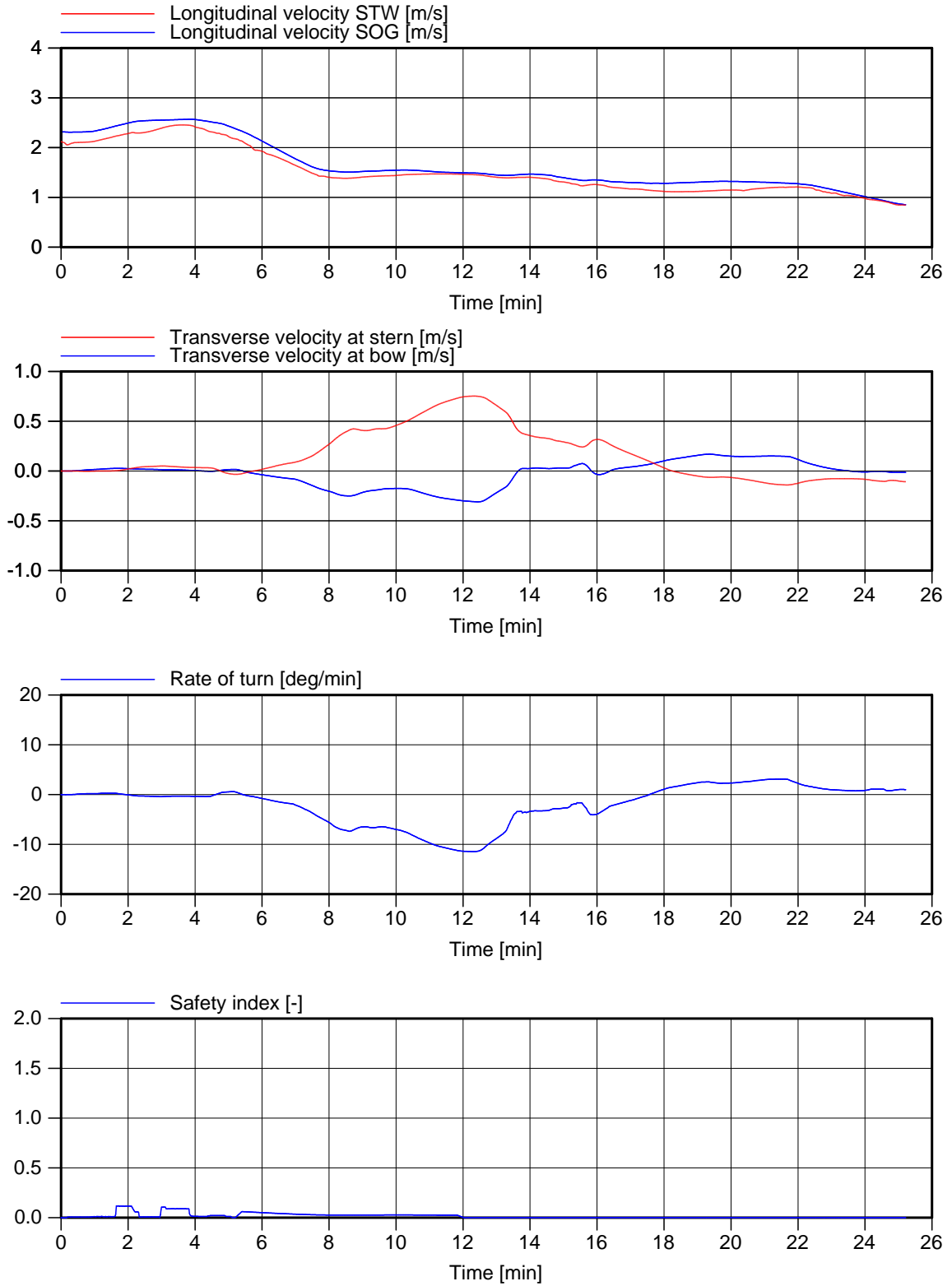

Ship data 2	Run: 16-7 Arr
Ship: VLCC 332x58x21.0	Wind: NW 15.5 m/s
Current: Flood max	Figure: 7.d

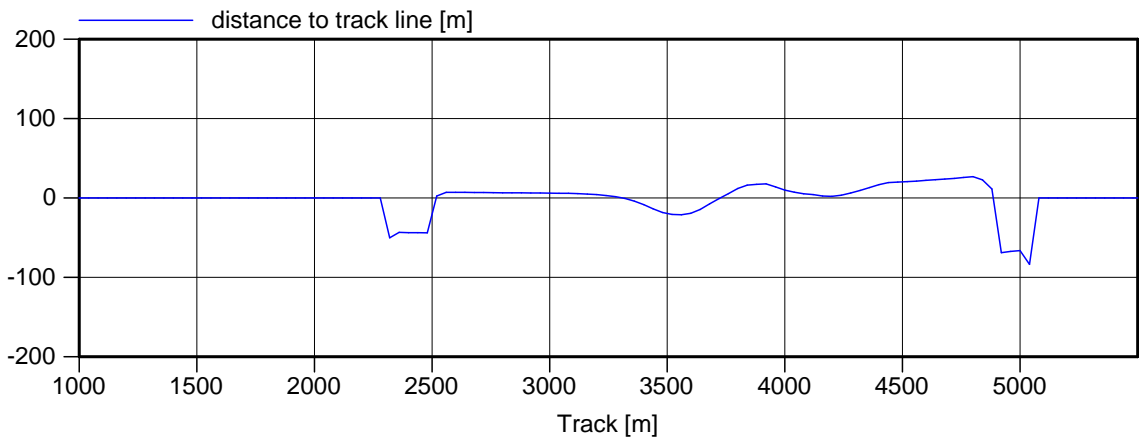
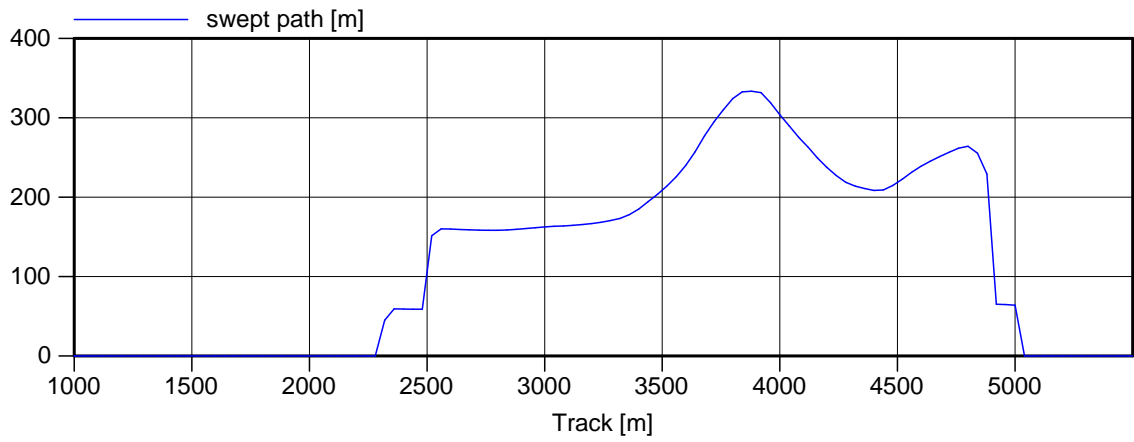

Space used	Run: 16-7 Arr
Ship: VLCC 332x58x21.0	Wind: NW 15.5 m/s
Current: Flood max	Figure: 7.e

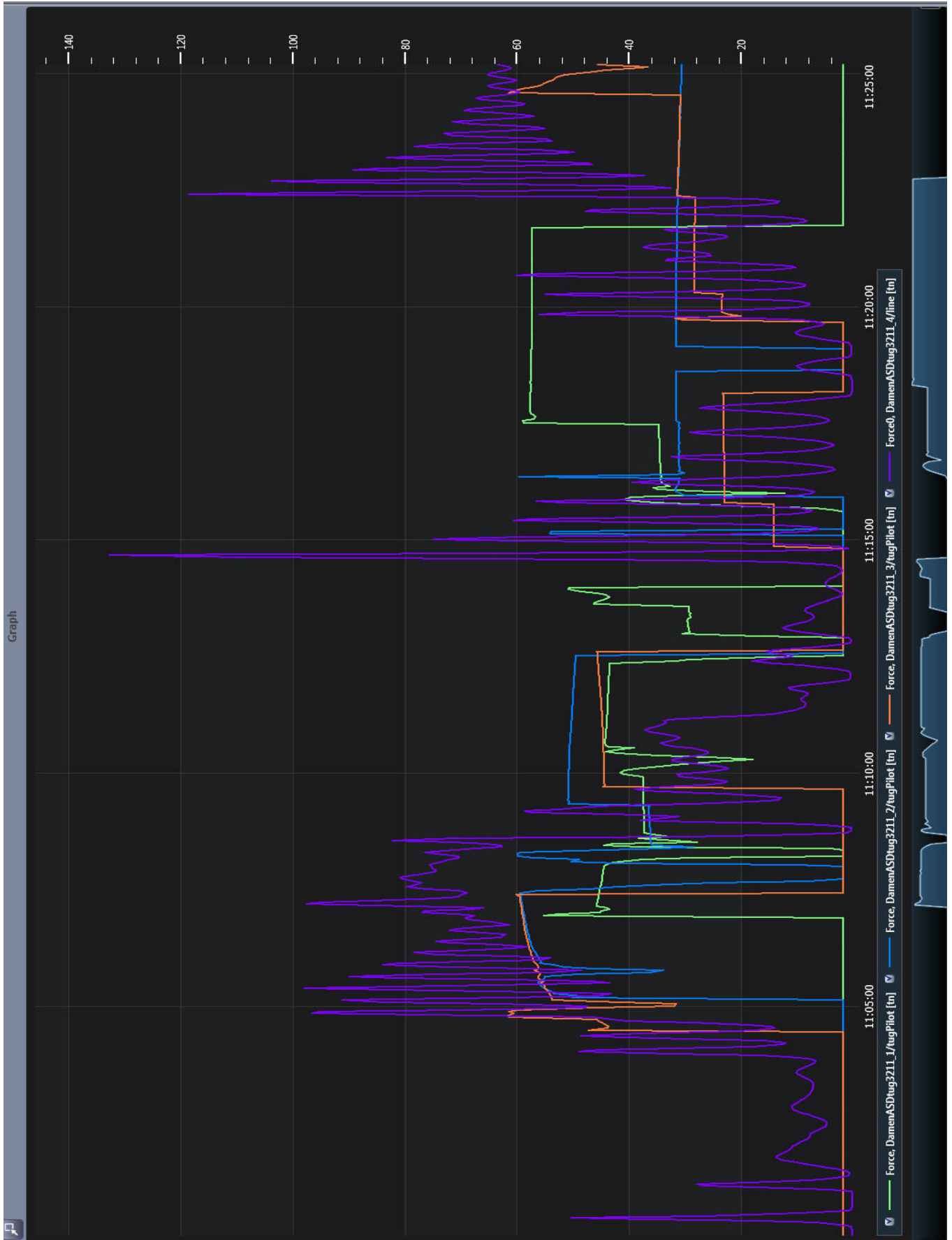

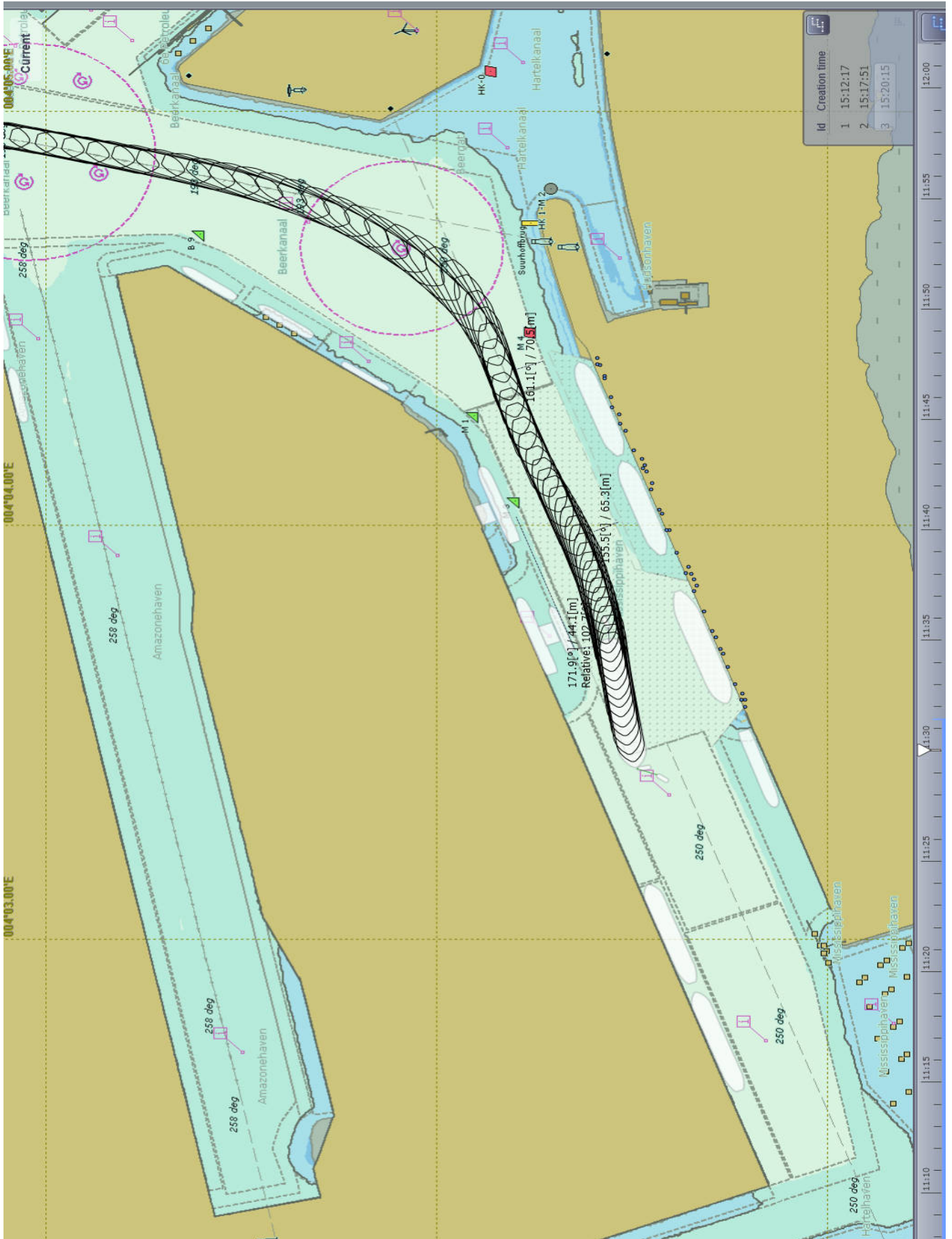

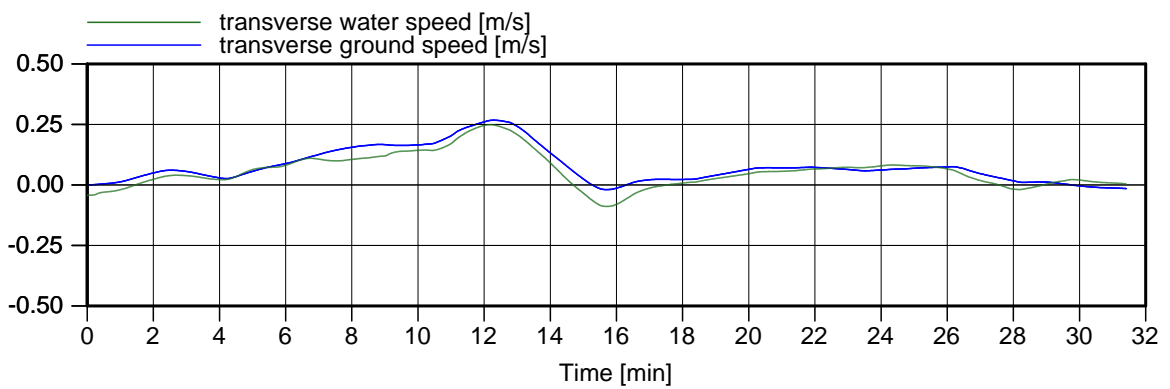
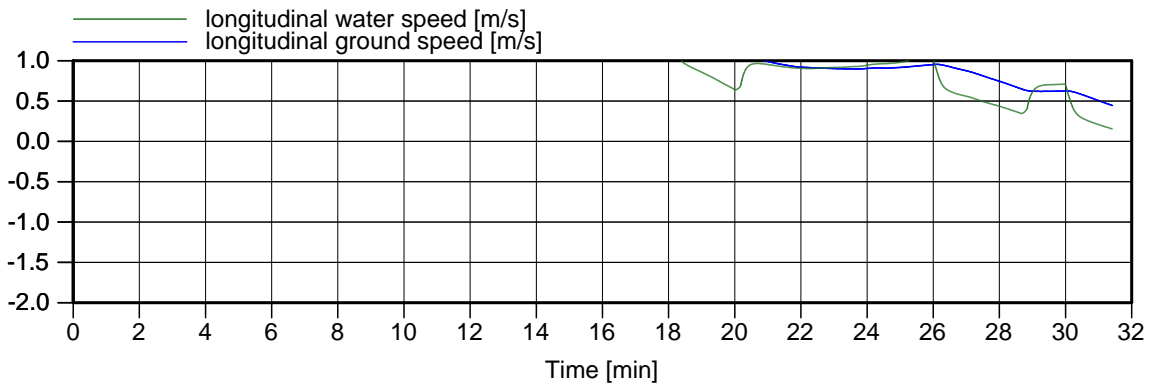
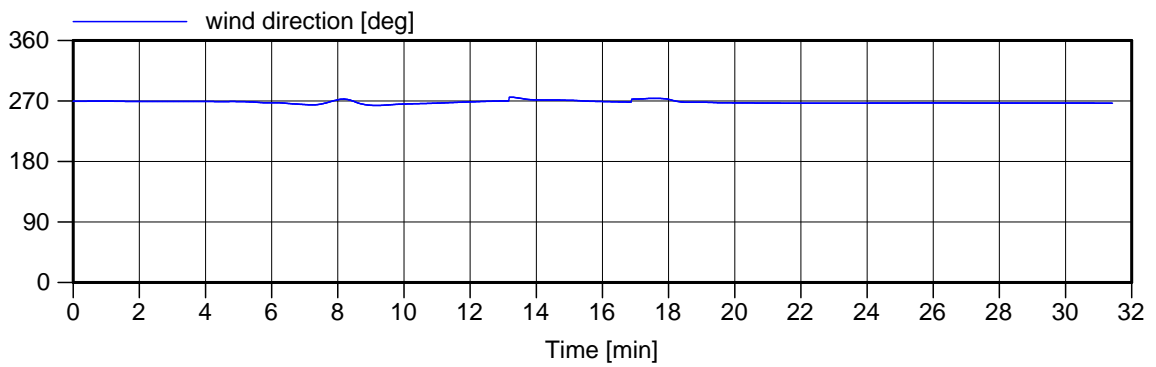
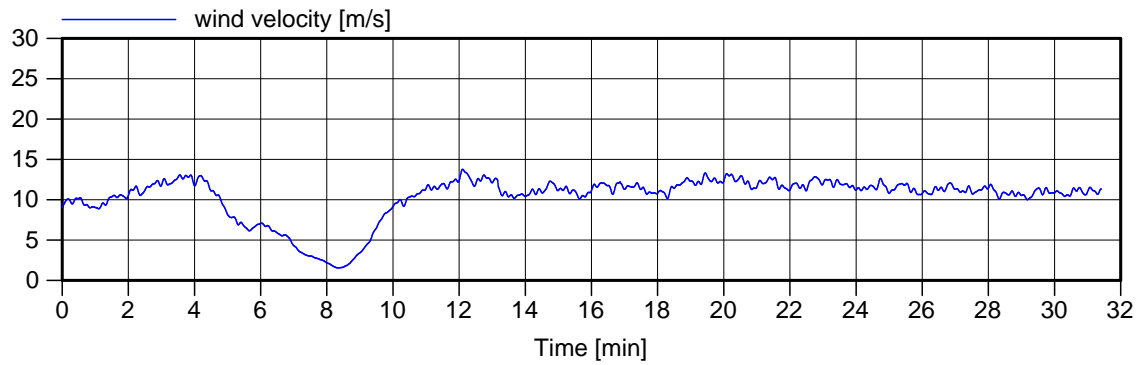

Environment

Run: 16-8 Arr

Ship: Valemax 362x65x22.6

Wind: W 15.5 m/s

Current: Flood max

Figure: 8.b

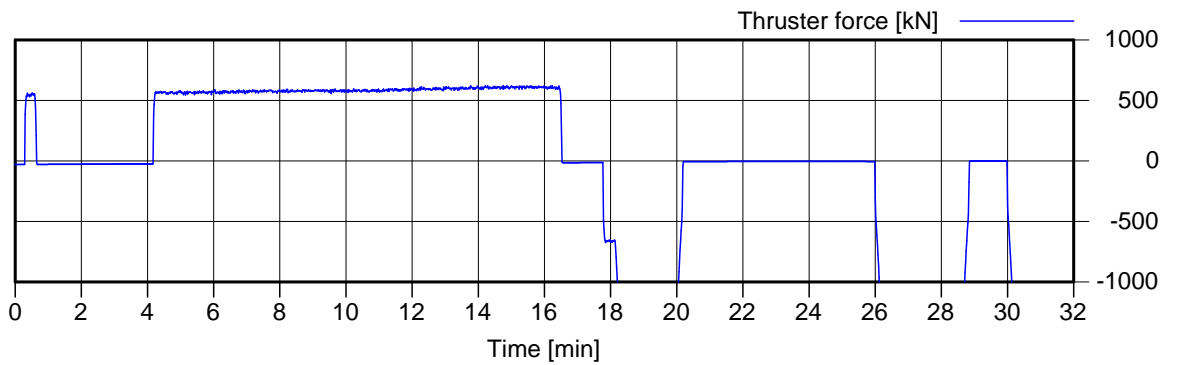
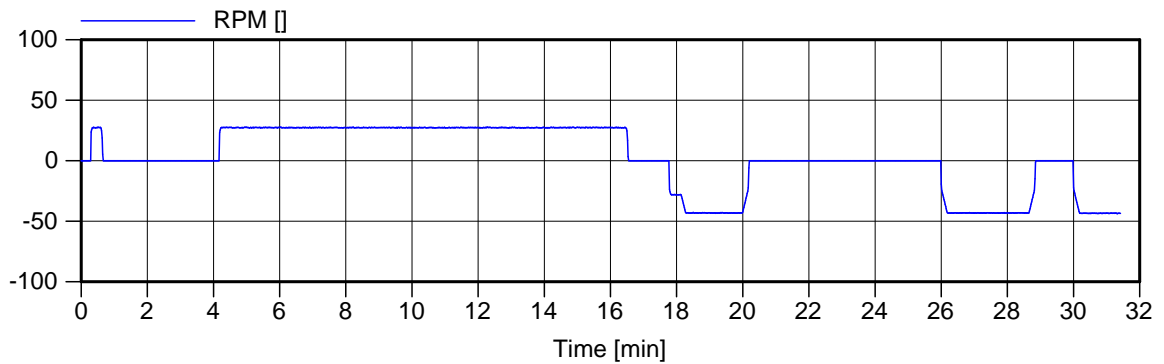
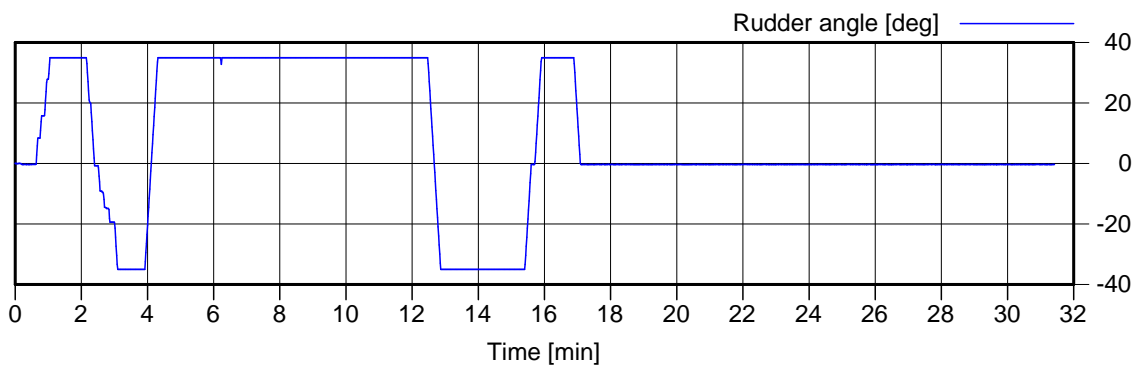
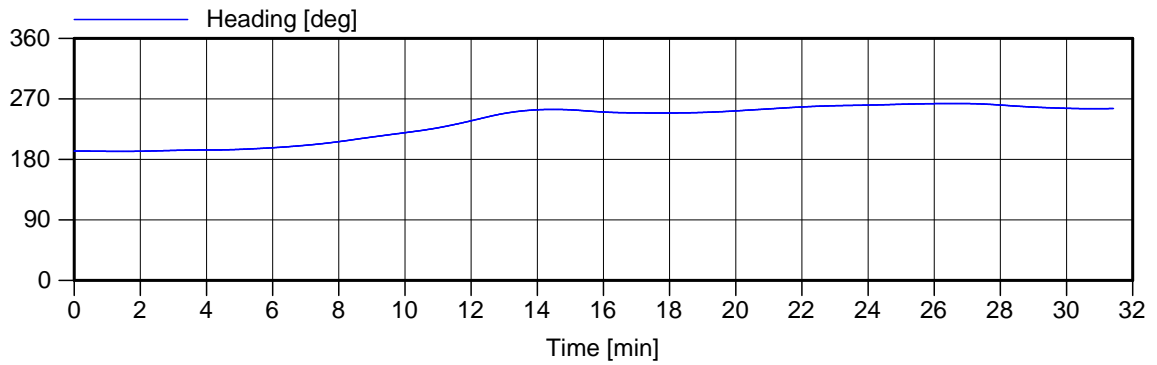

Ship data 1

Ship: Valemax 362x65x22.6

Current: Flood max

Run: 16-8 Arr

Wind: W 15.5 m/s

Figure: 8.c

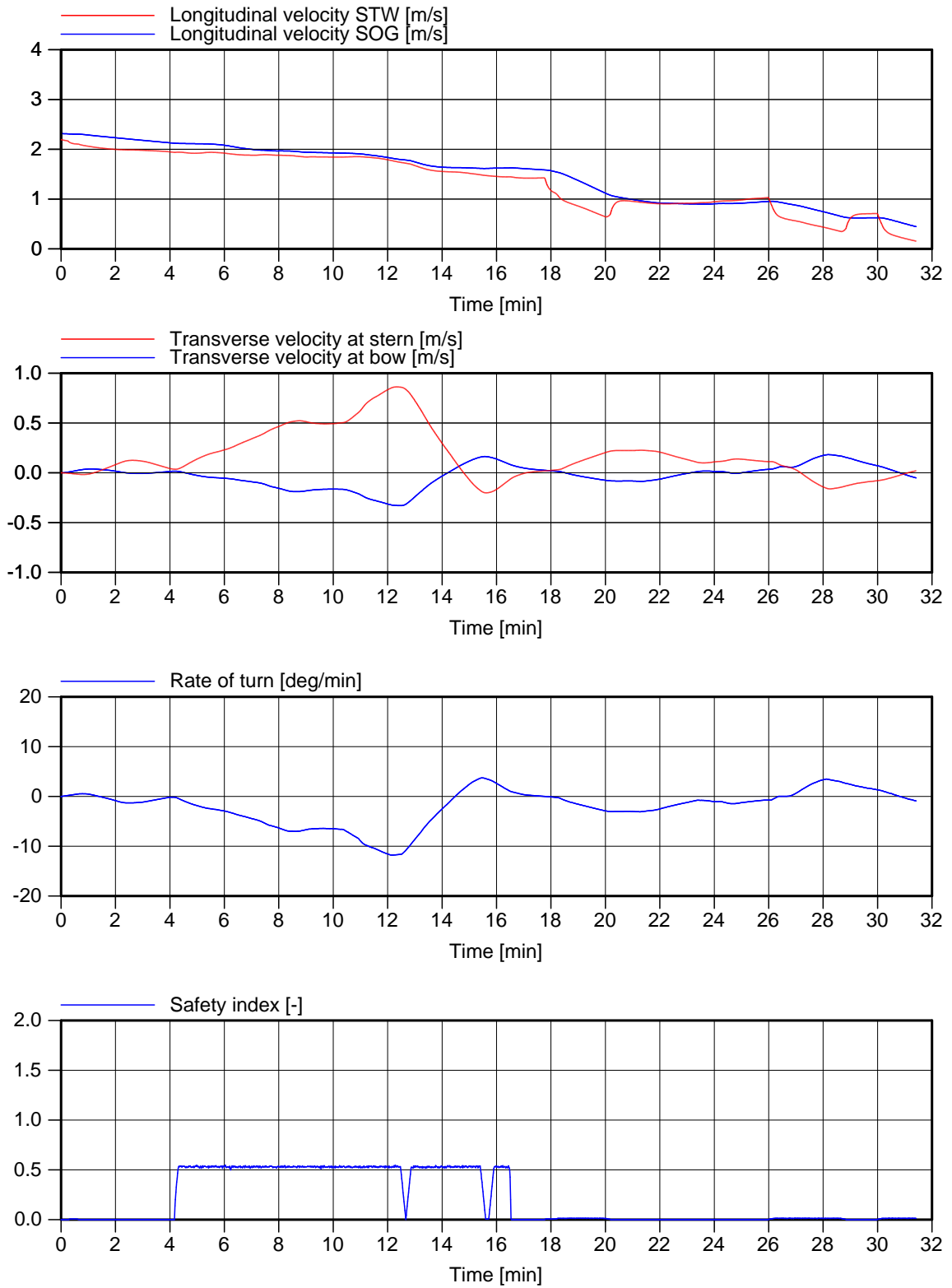

Ship data 2

Ship: Valemax 362x65x22.6

Current: Flood max

Run: 16-8 Arr

Wind: W 15.5 m/s

Figure: 8.d

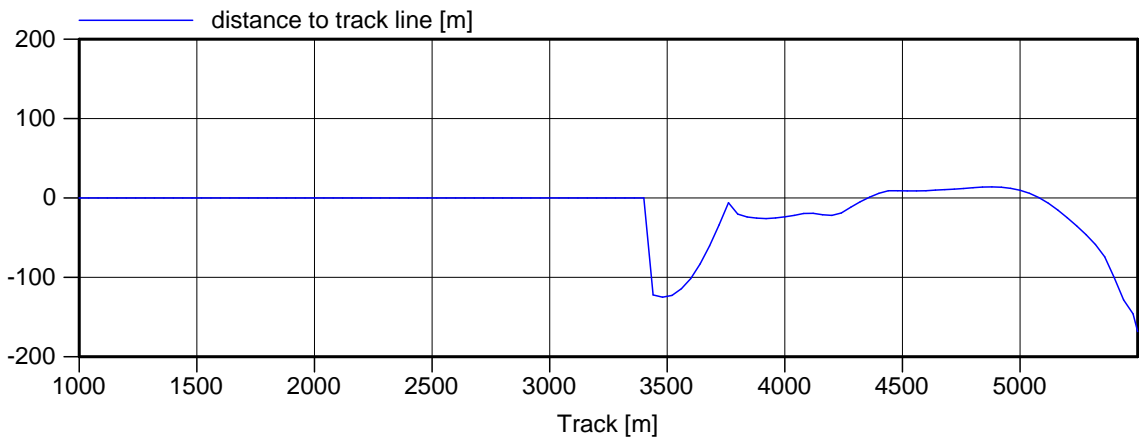
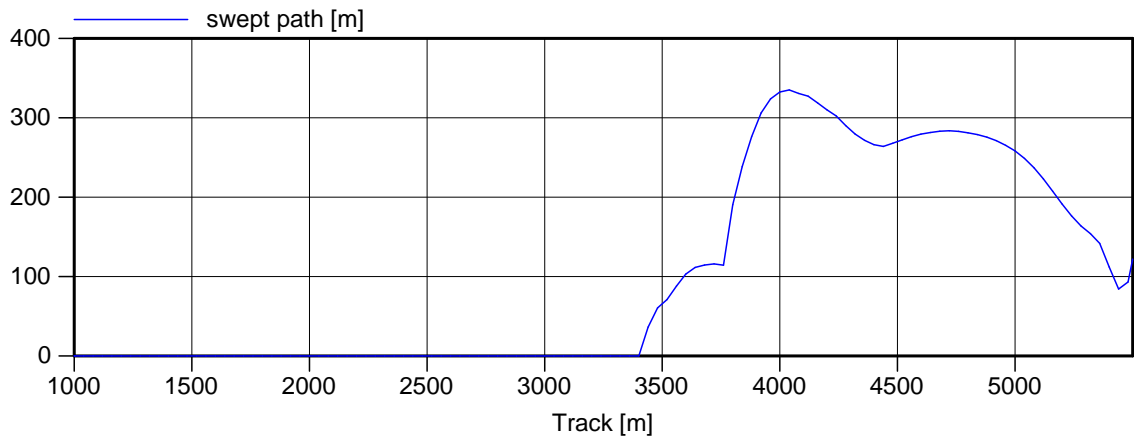

Space used	Run: 16-8 Arr
Ship: Valemax 362x65x22.6	Wind: W 15.5 m/s
Current: Flood max	Figure: 8.e

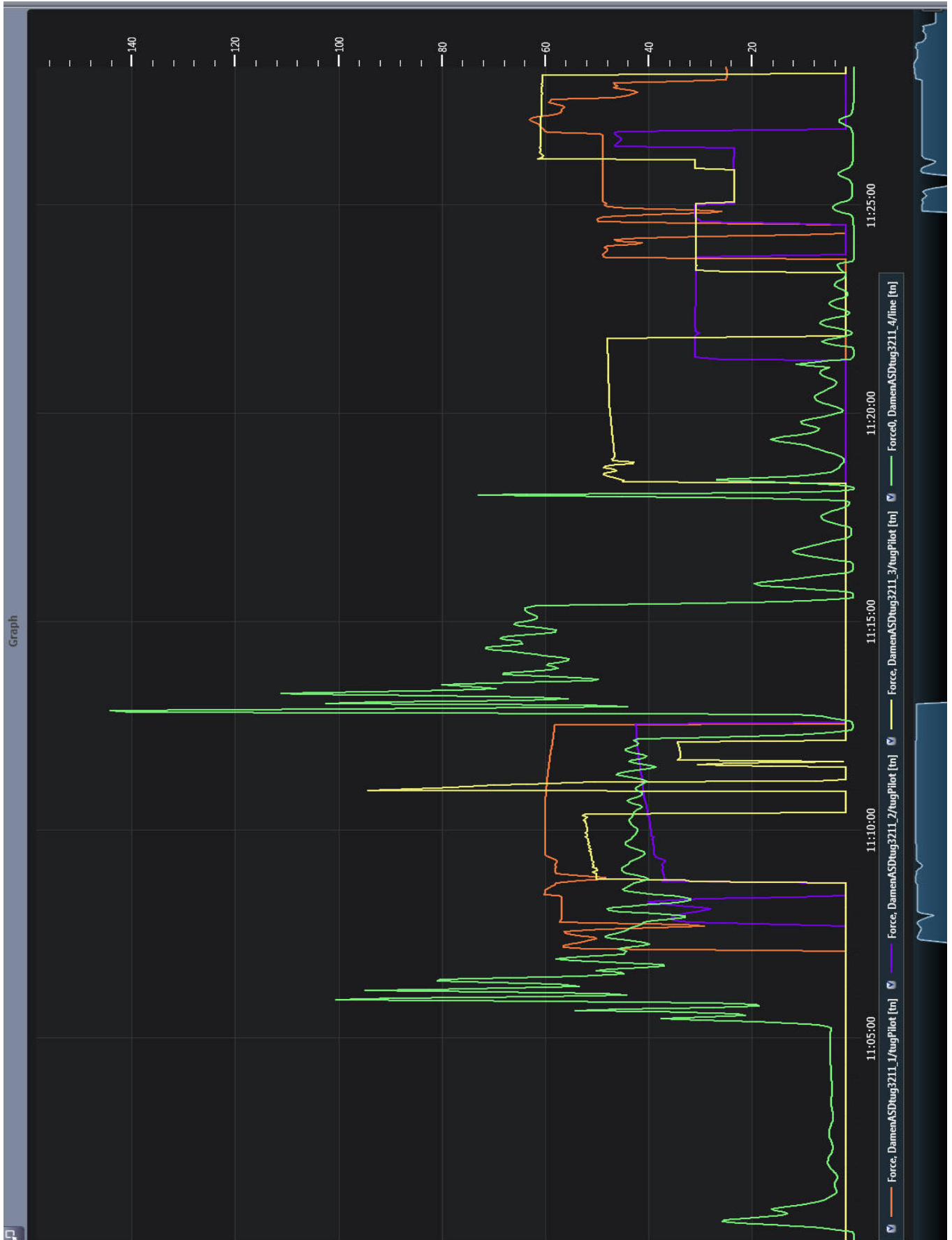

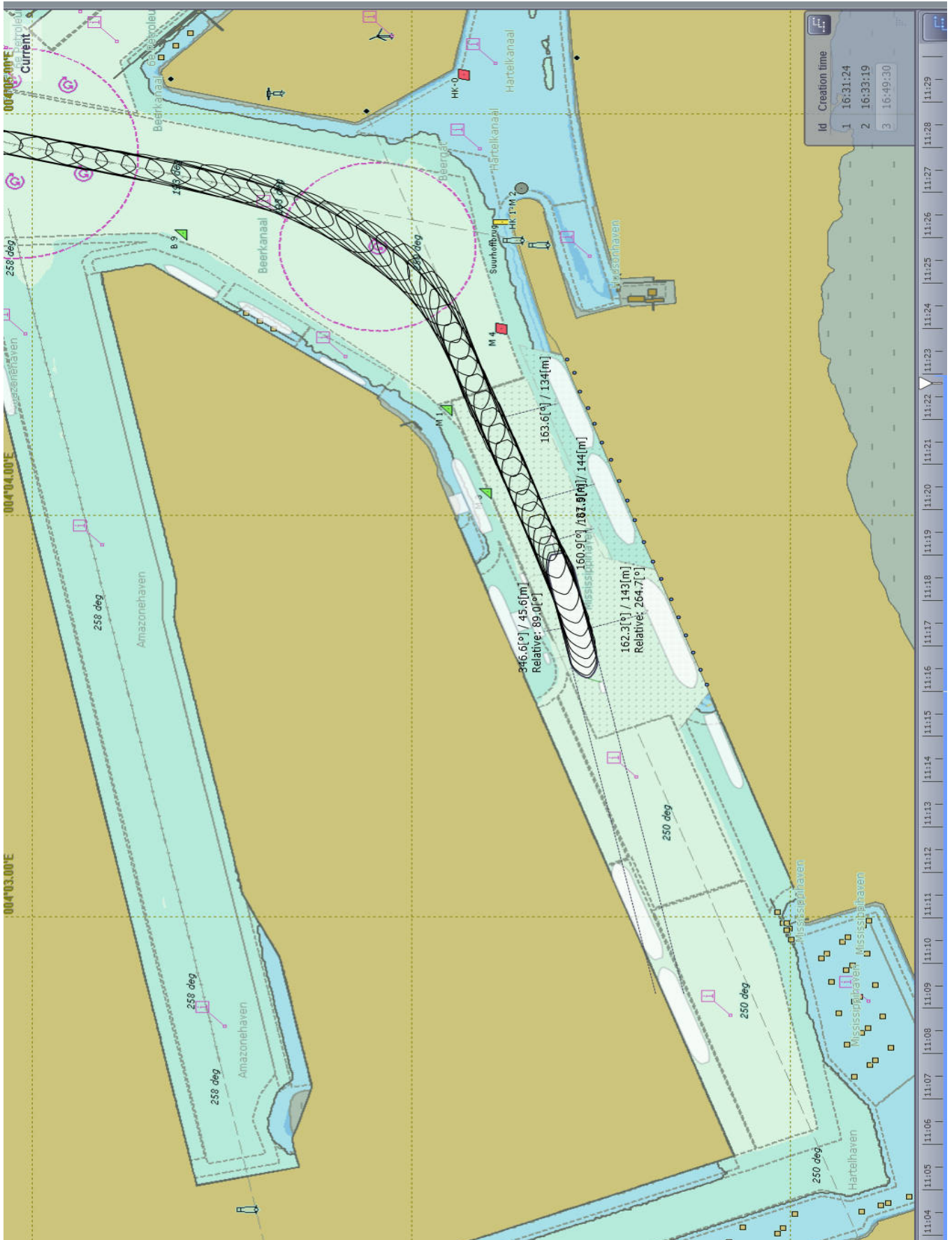

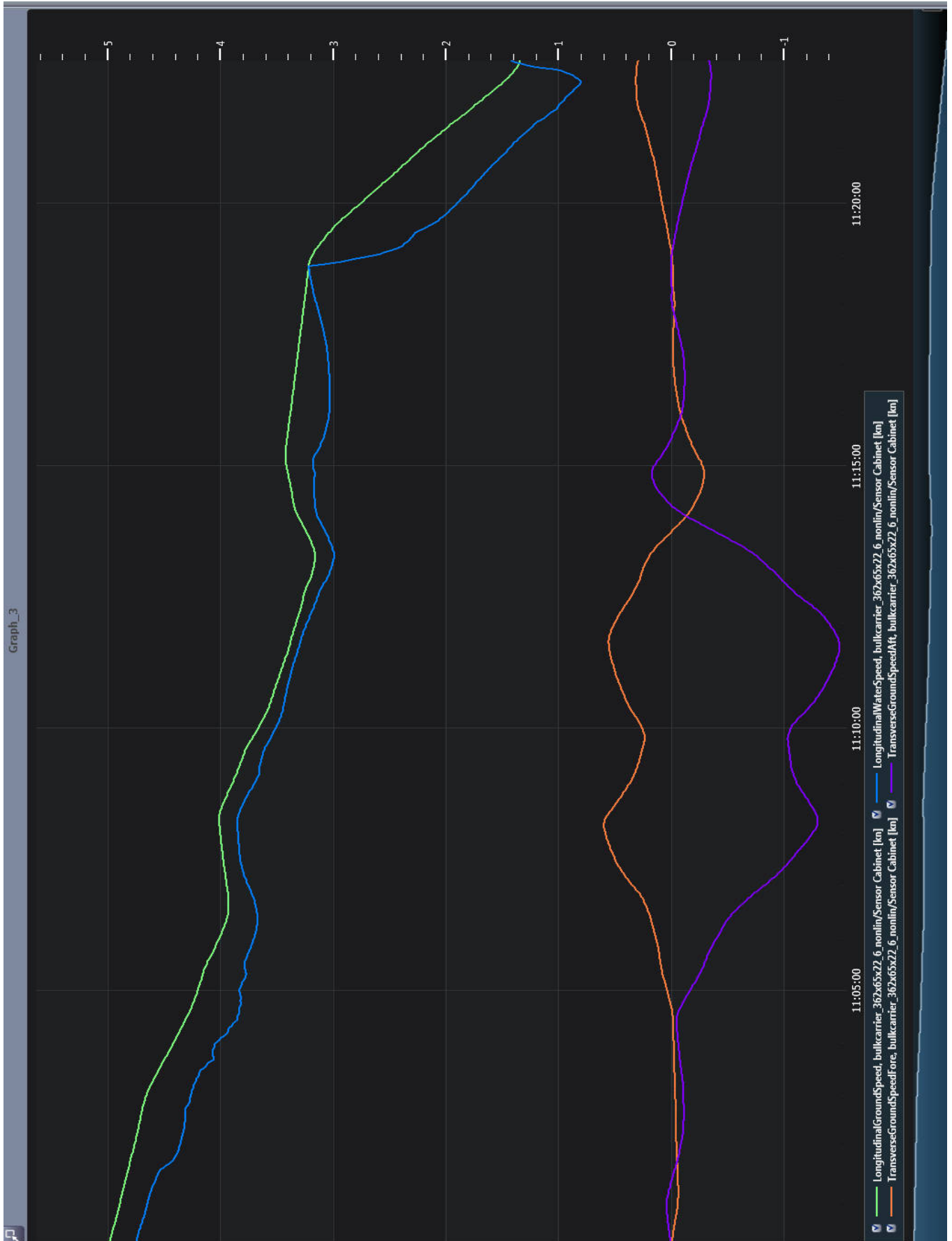

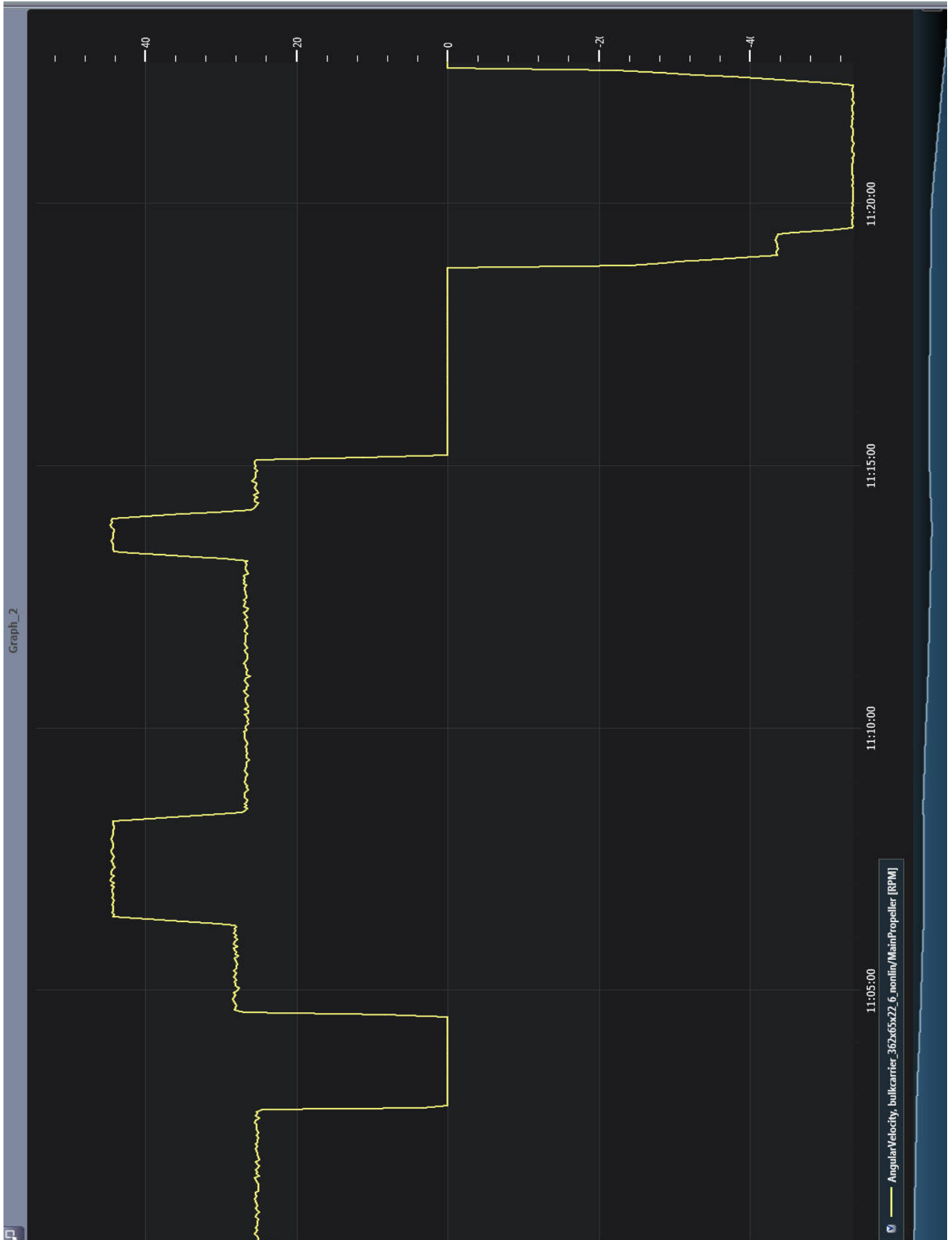

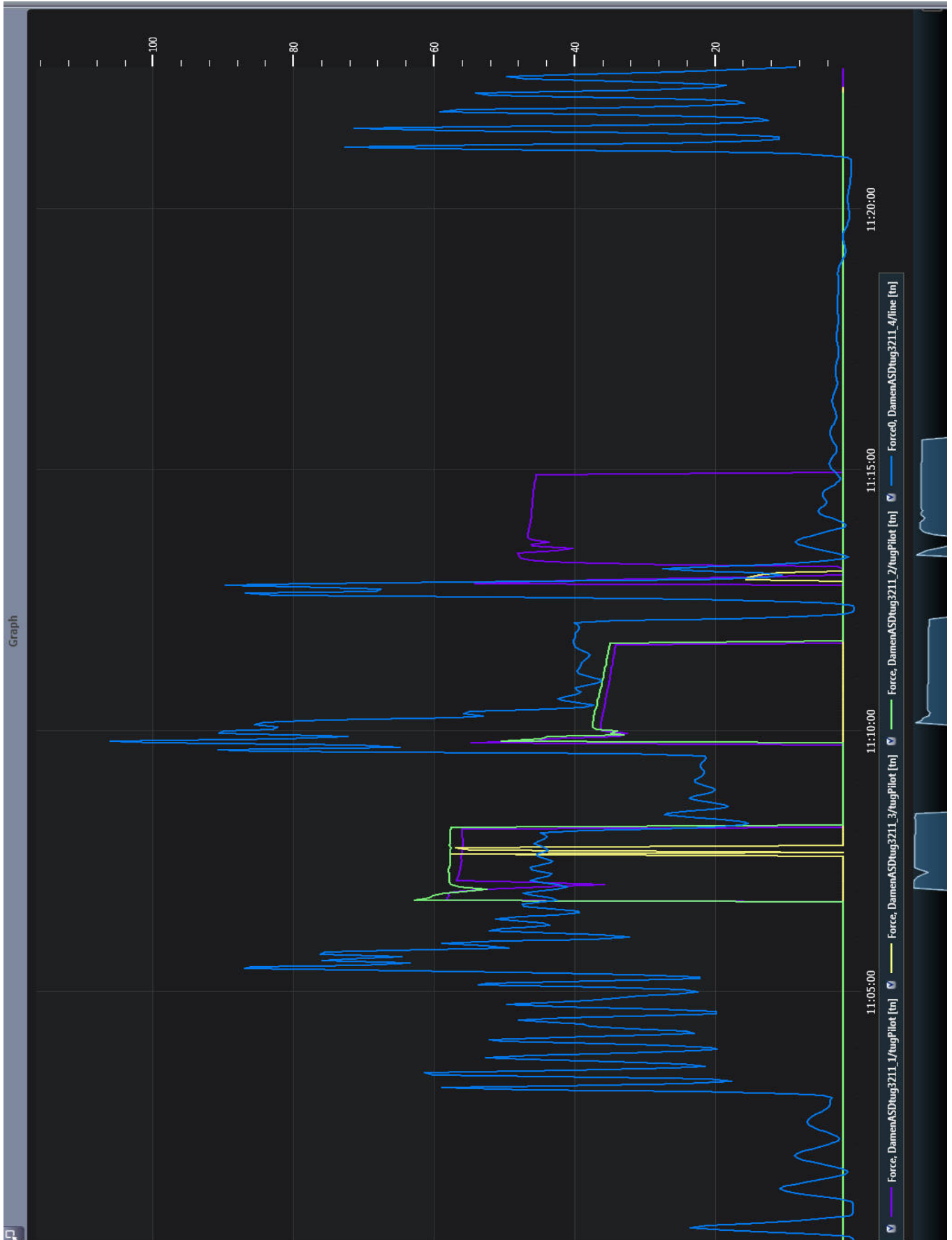

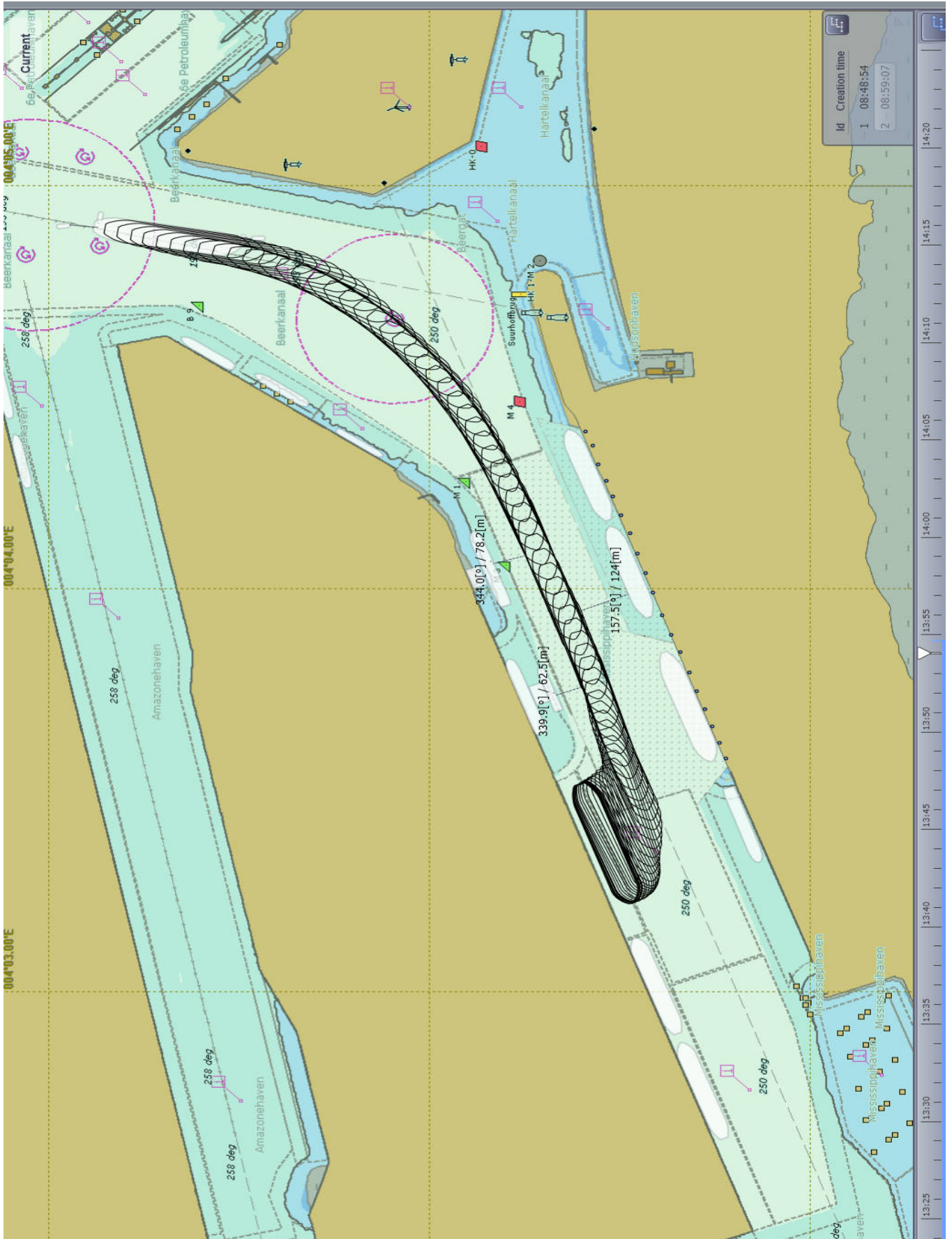

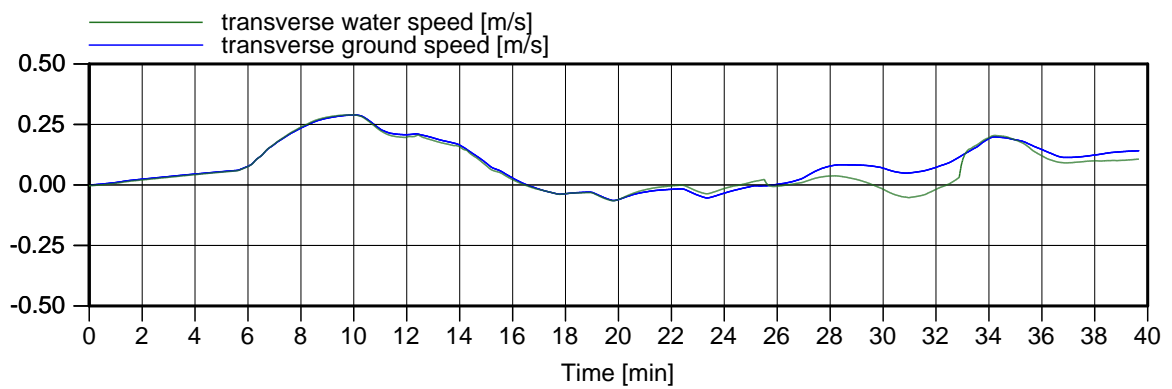
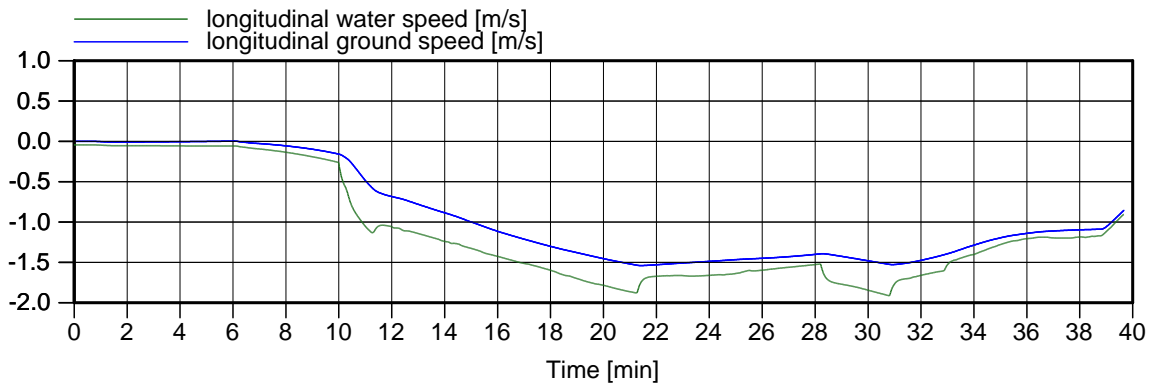
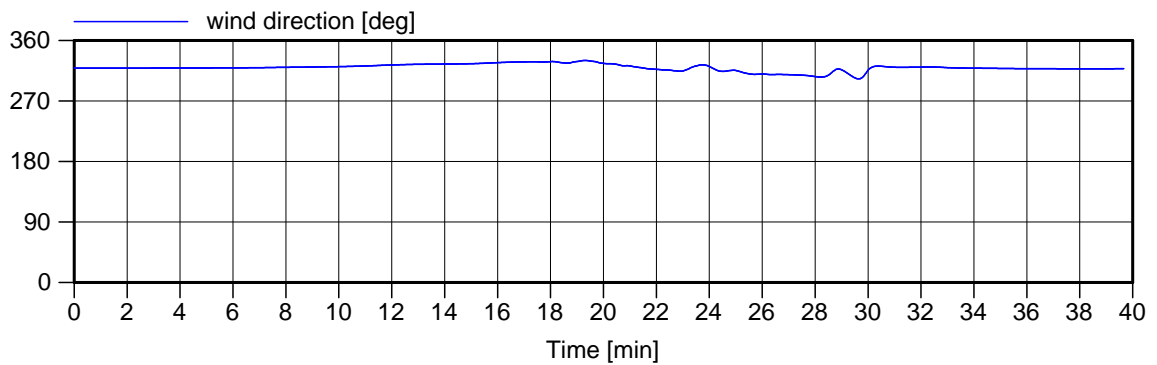
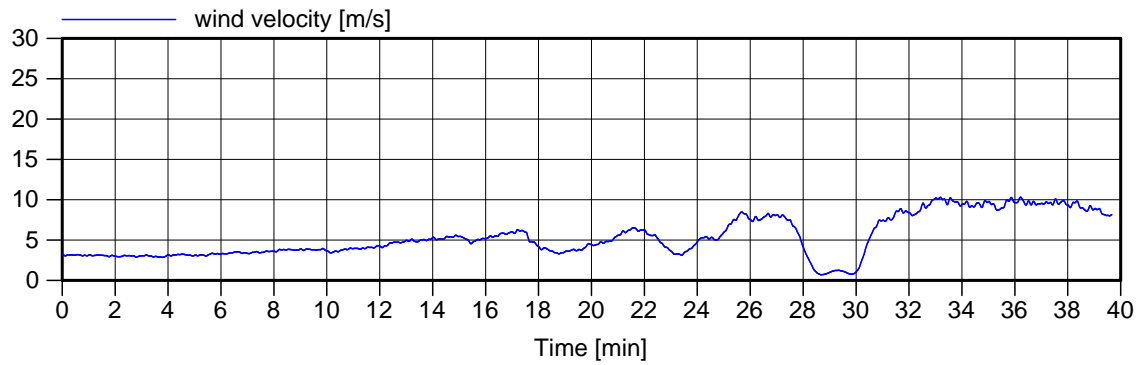

Environment

Run: 17-10 Dep

Ship: Valemax 362x65x14.0

Wind: NW 15.5 m/s

Current: Slack HW

Figure: 10.b

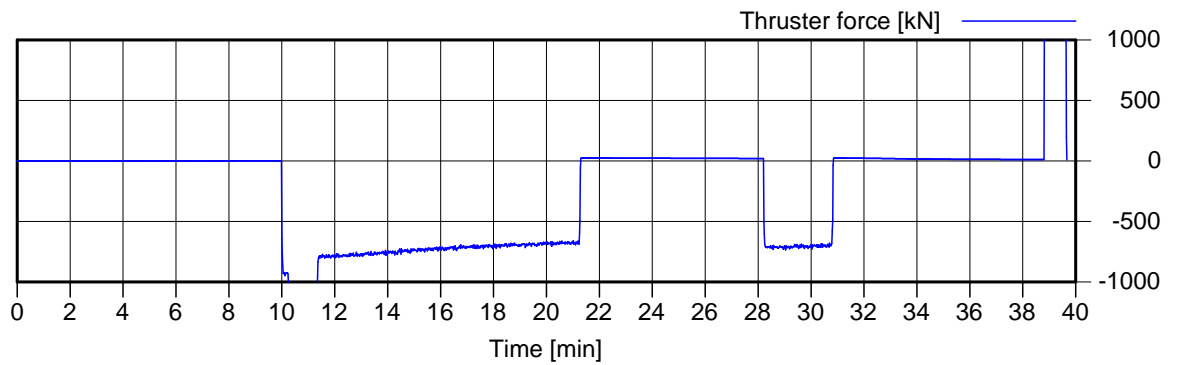
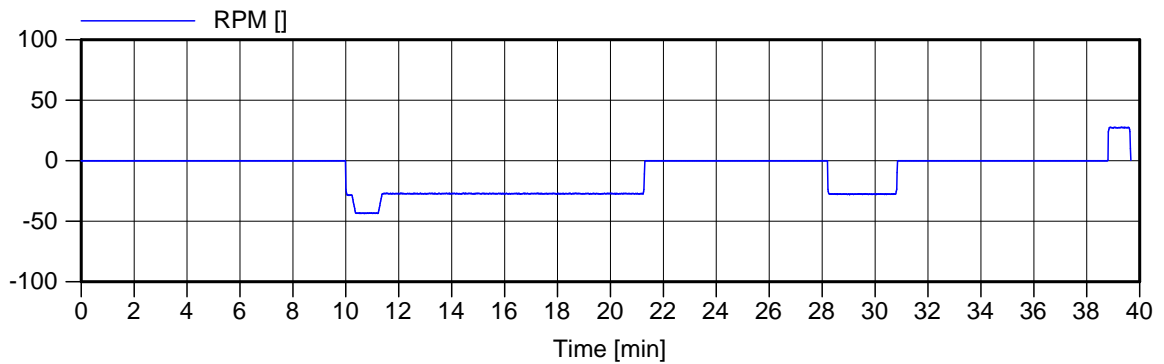
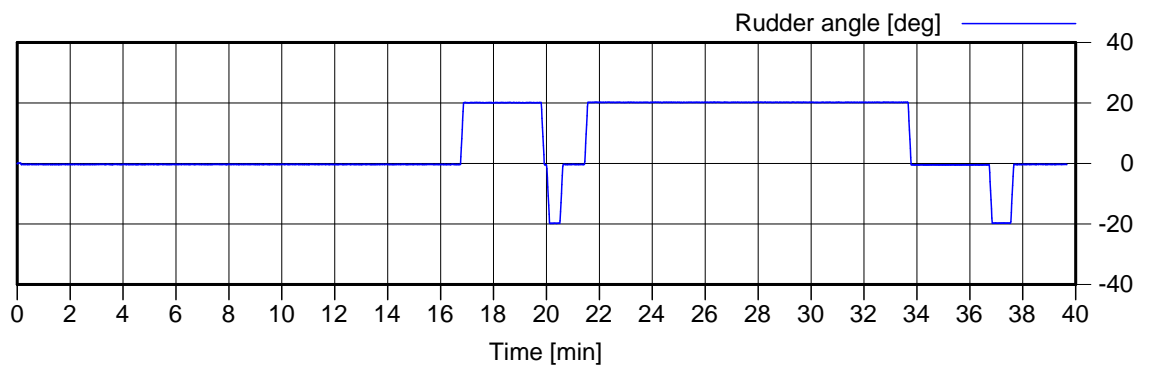
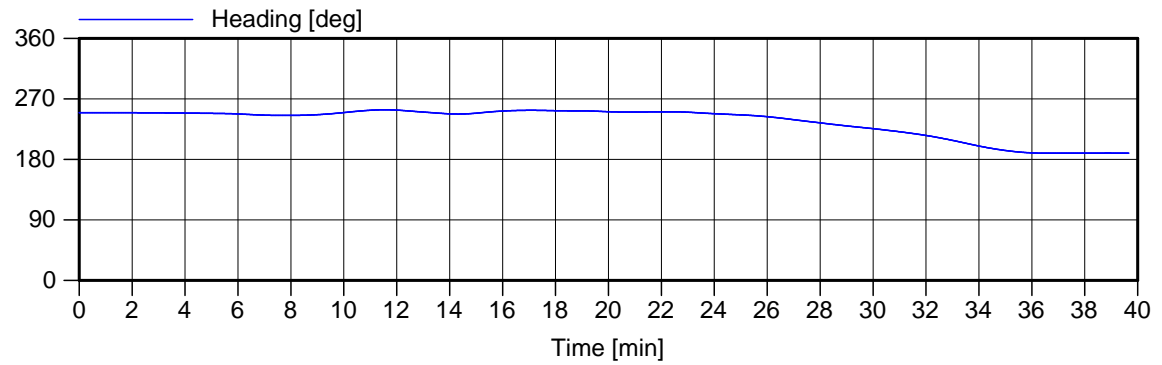

Ship data 1

Ship: Valemax 362x65x14.0

Current: Slack HW

Run: 17-10 Dep

Wind: NW 15.5 m/s

Figure: 10.c

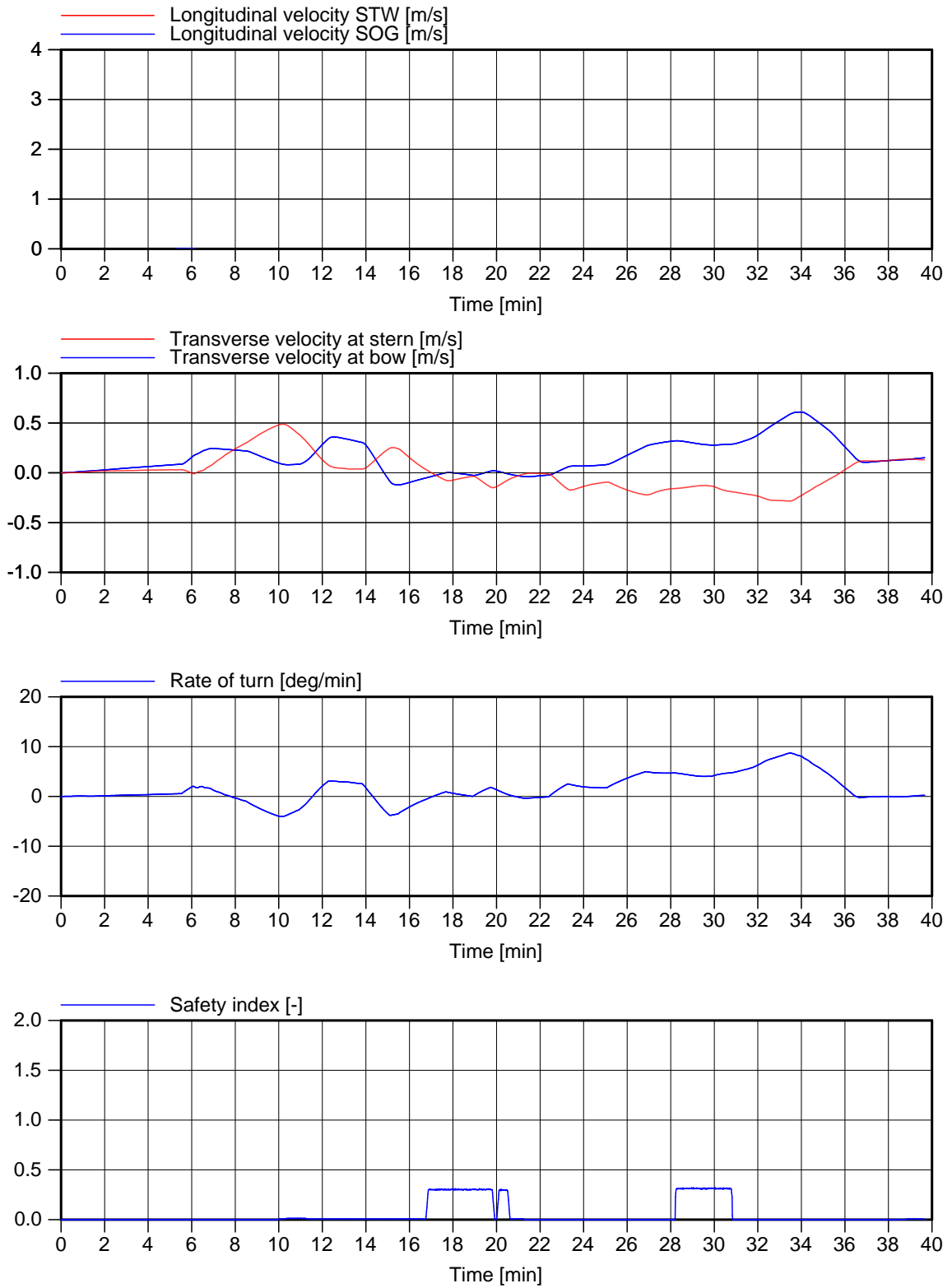

Ship data 2

Ship: Valemax 362x65x14.0

Current: Slack HW

Run: 17-10 Dep

Wind: NW 15.5 m/s

Figure: 10.d

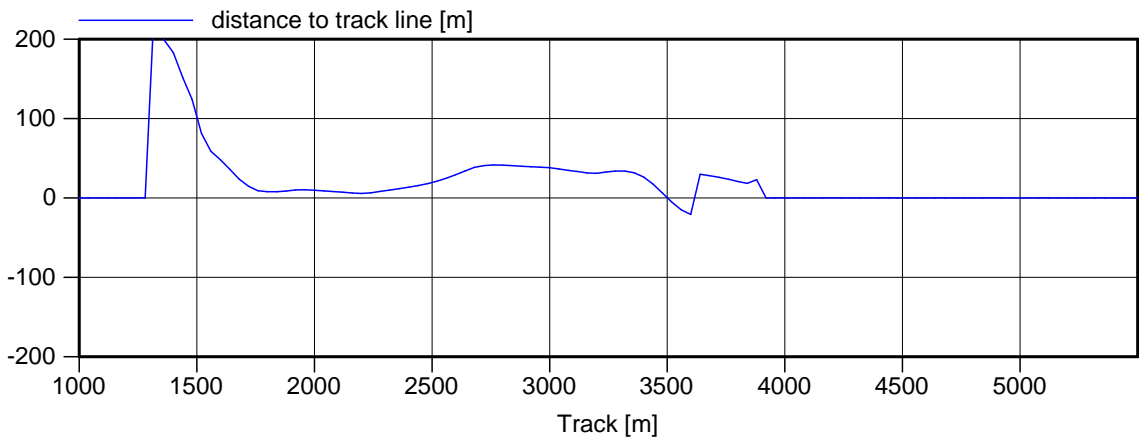
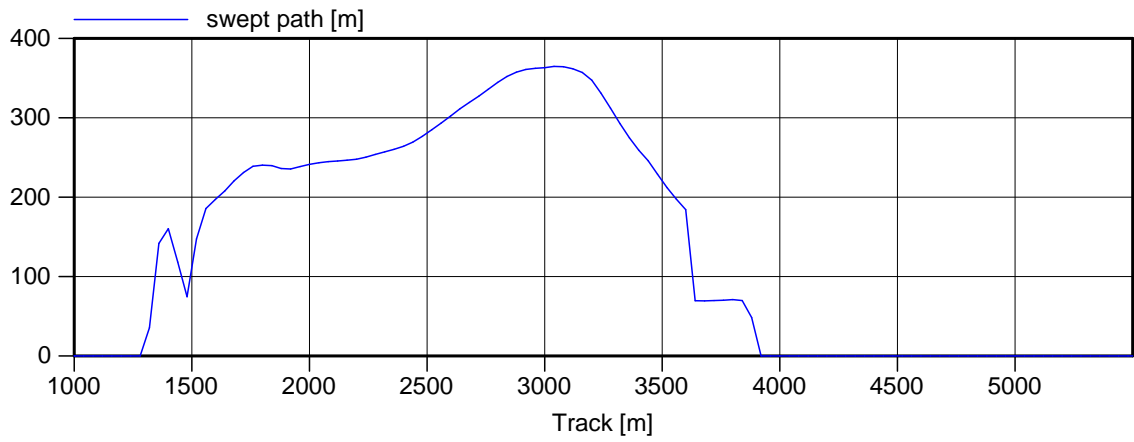

Space used	Run: 17-10 Dep
Ship: Valemax 362x65x14.0	Wind: NW 15.5 m/s
Current: Slack HW	Figure: 10.e

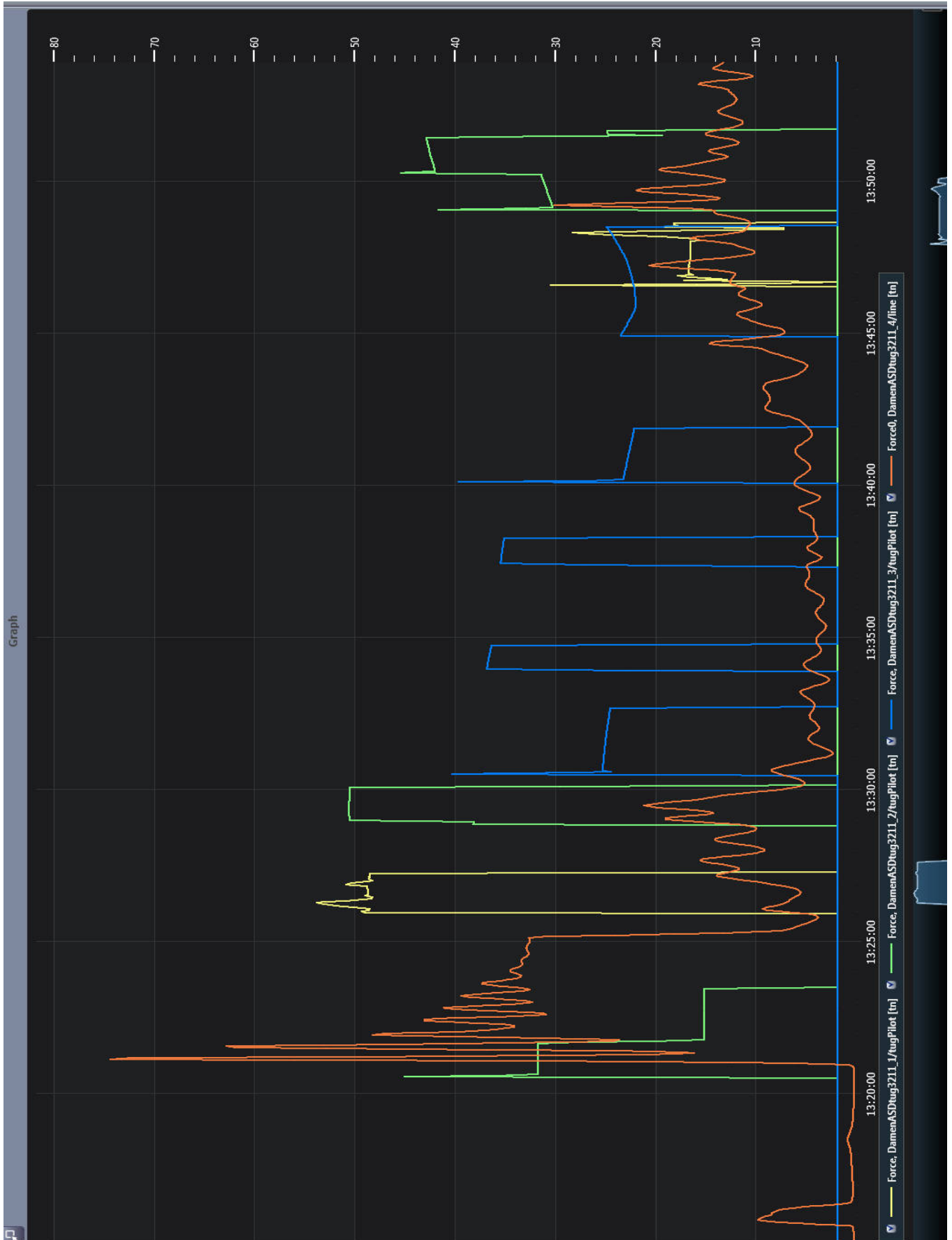

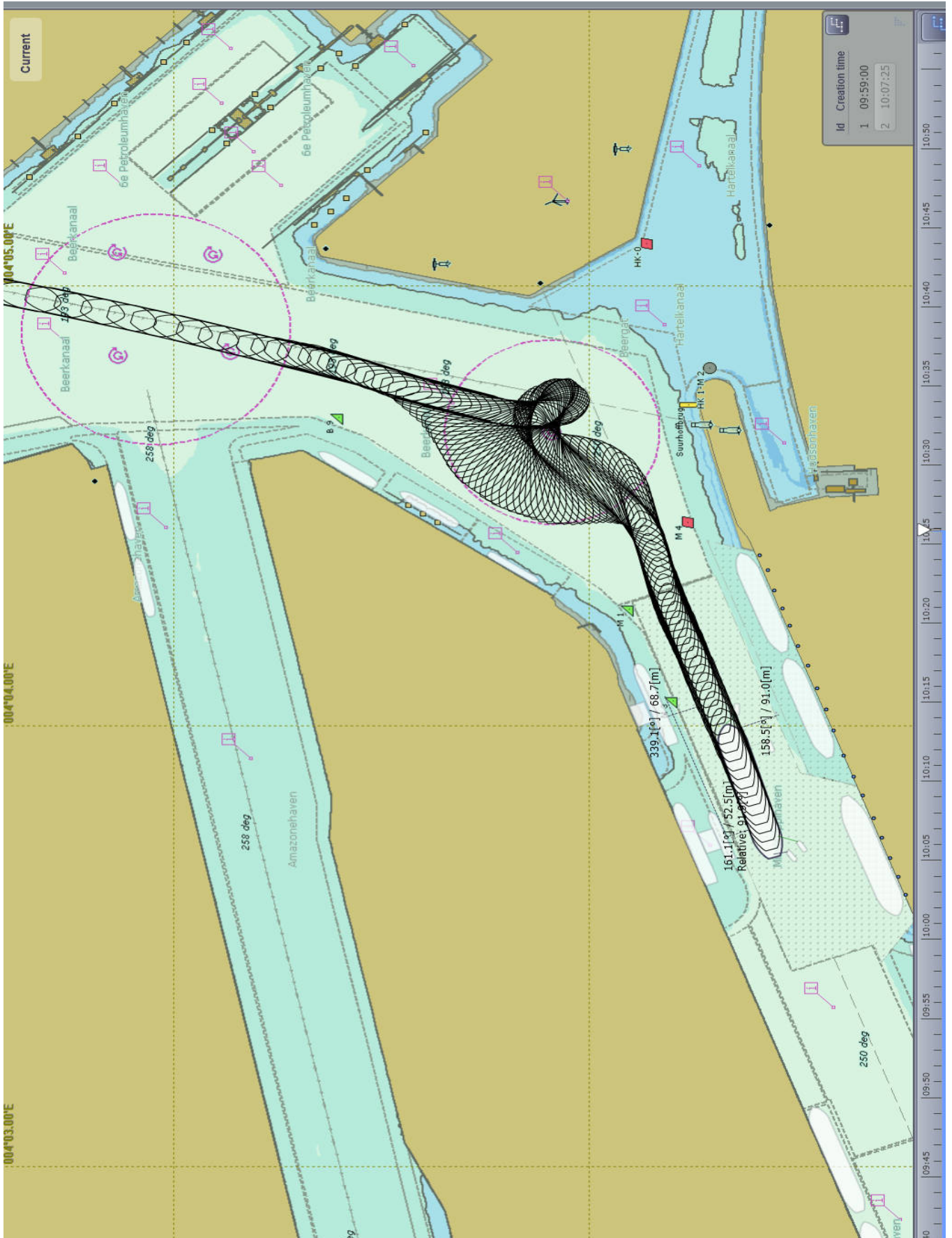

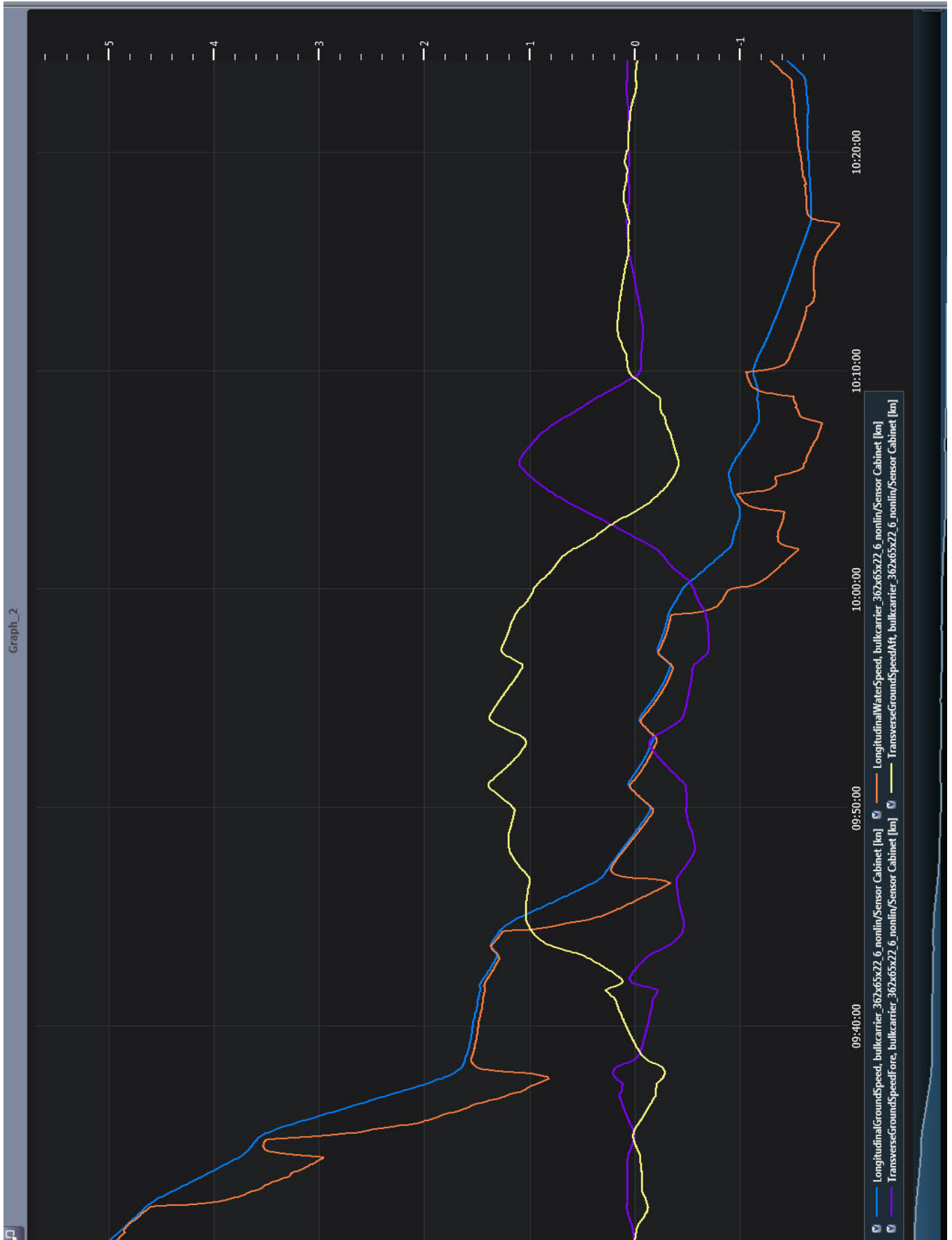

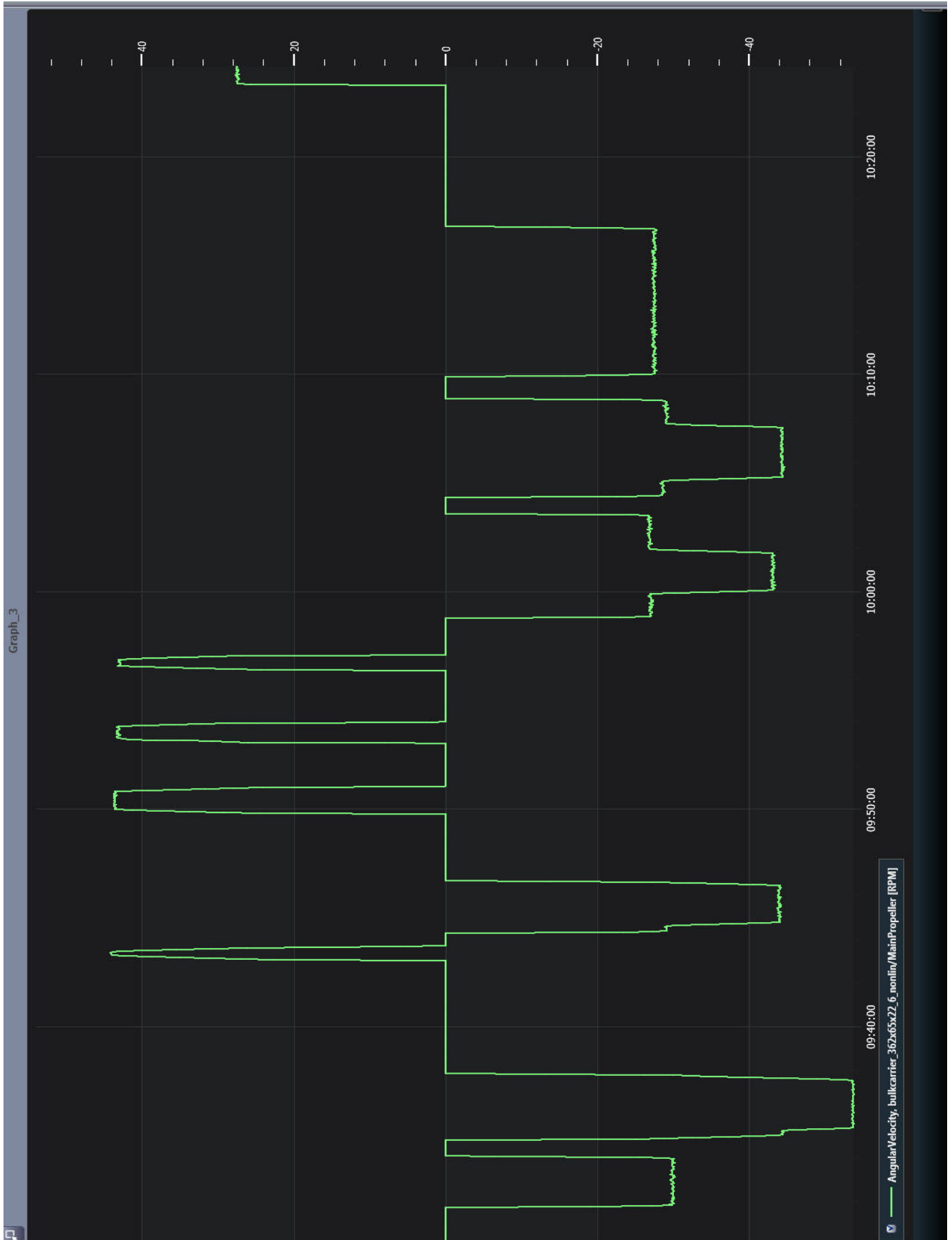

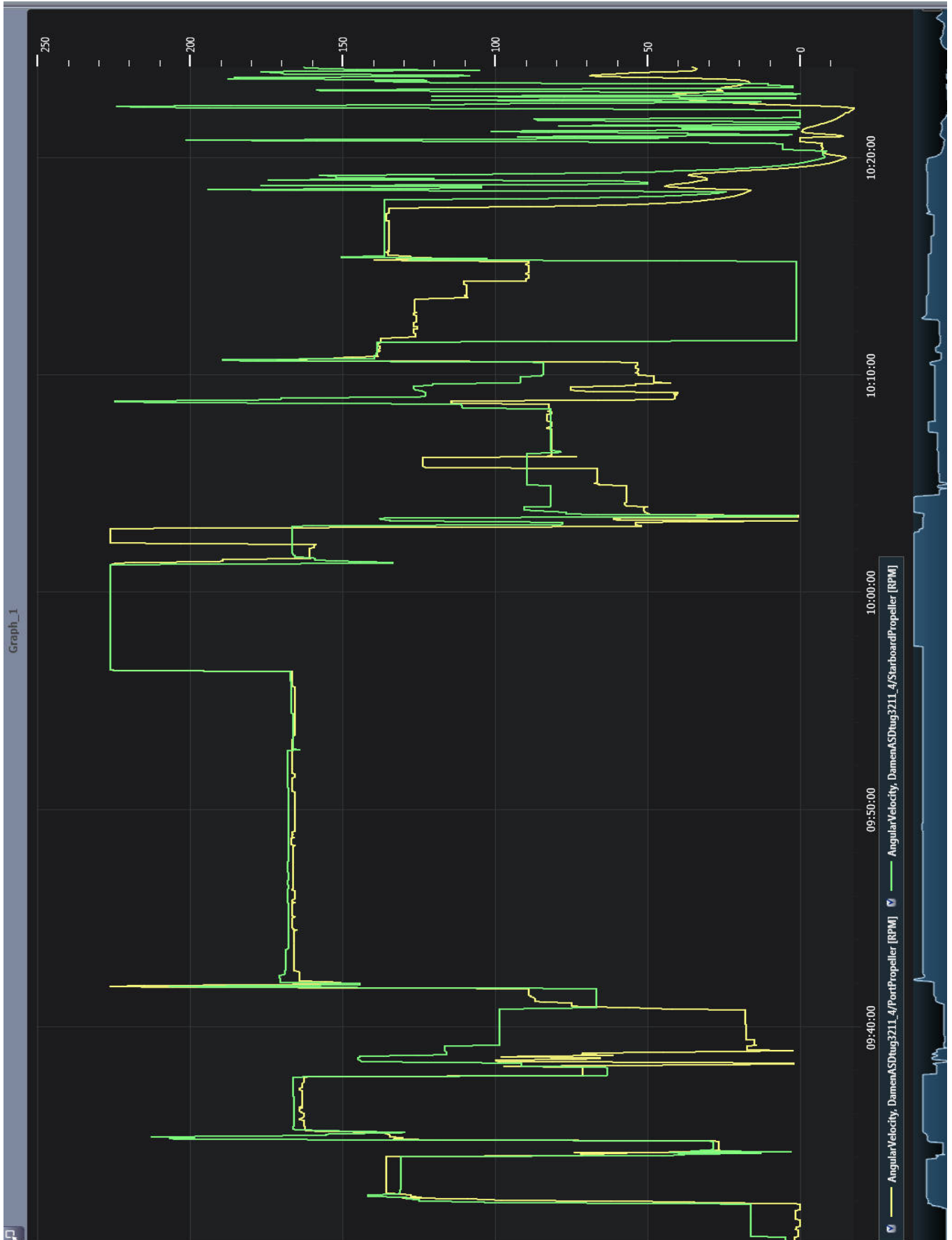

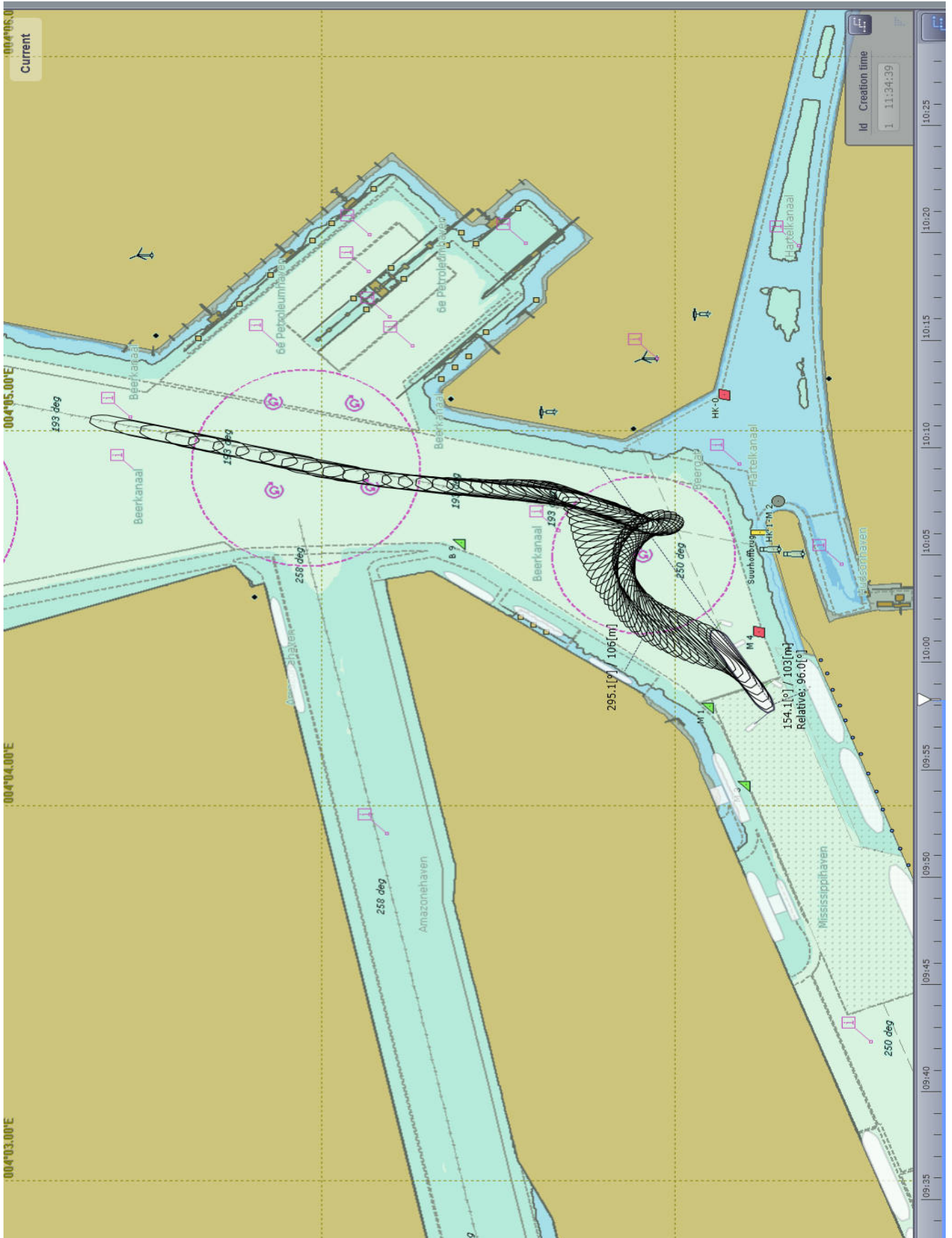

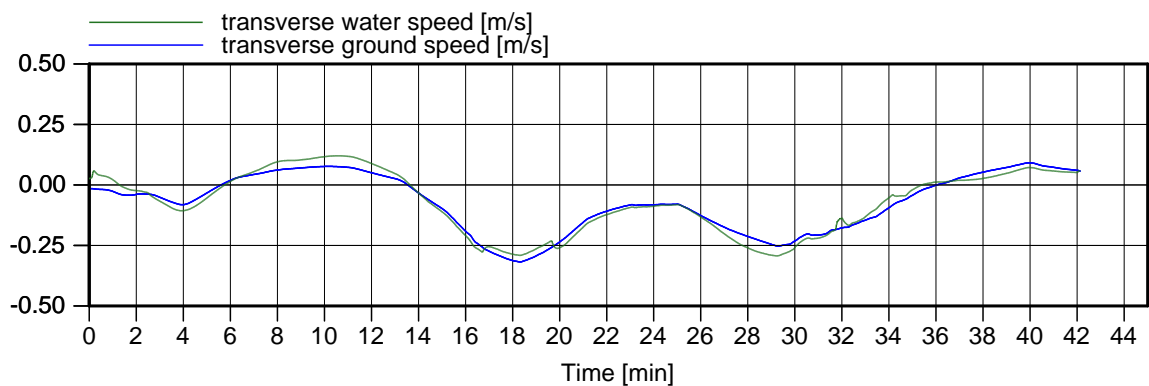
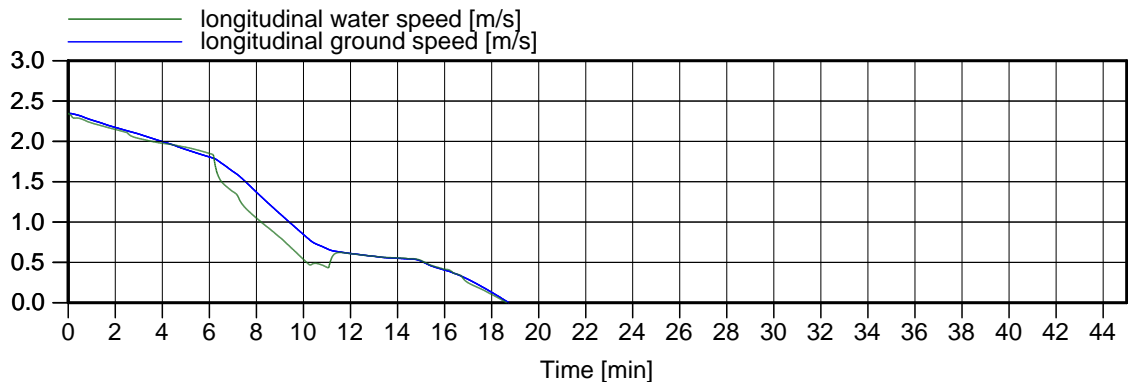
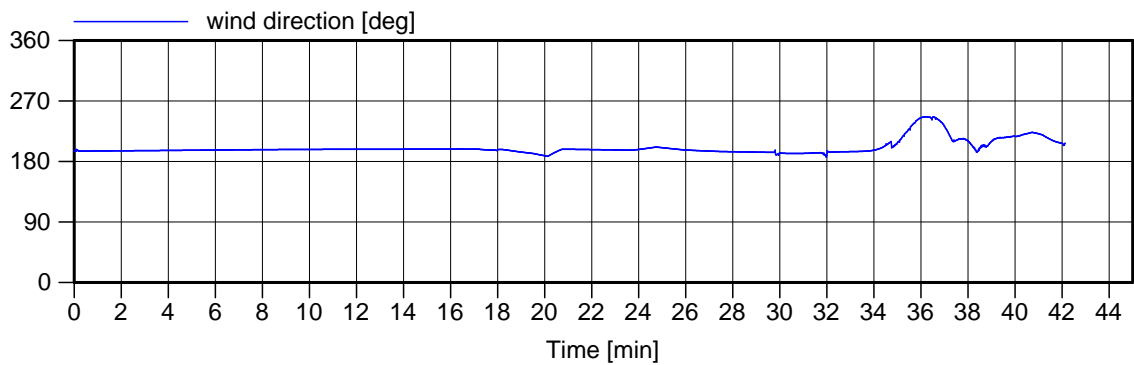
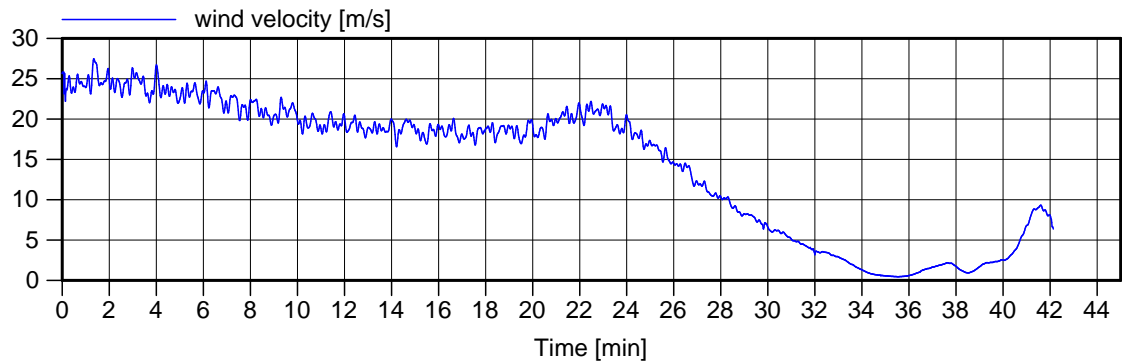

Environment	Run: 17-12 Arr
Ship: Capesize 292x45x18.5	Wind: SSW 15.5 m/s
Current: Slack LW	Figure: 12.b

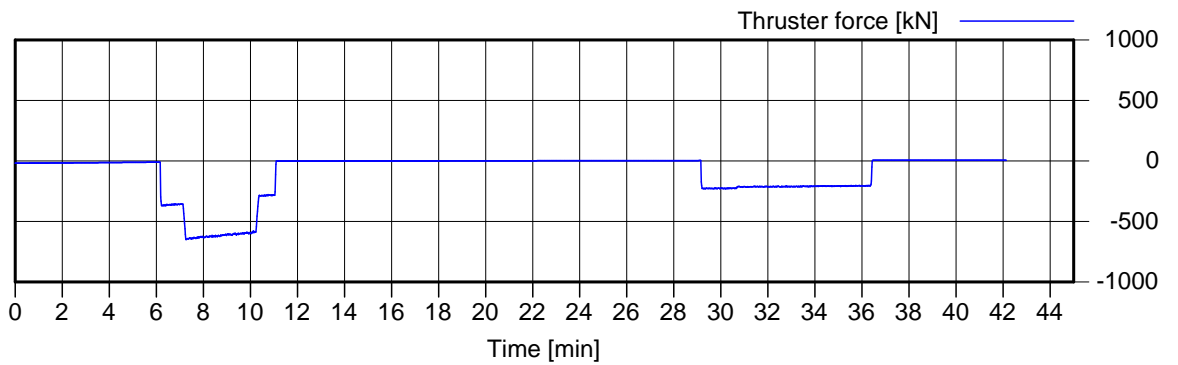
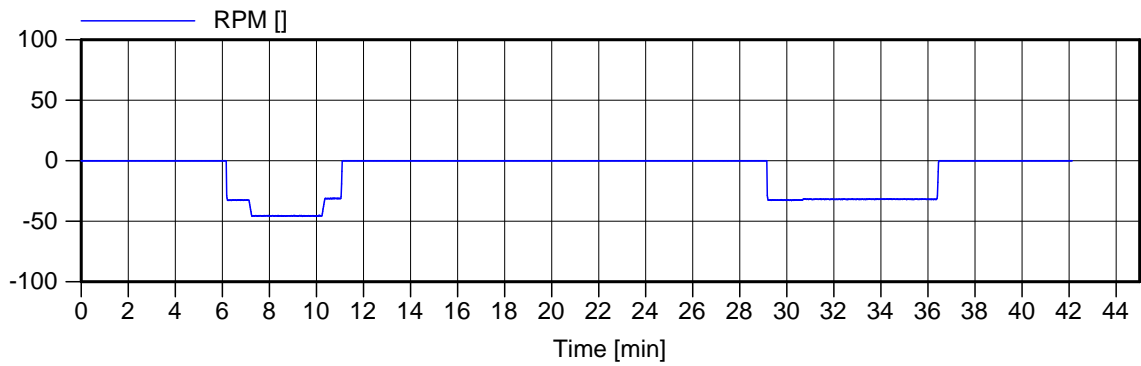
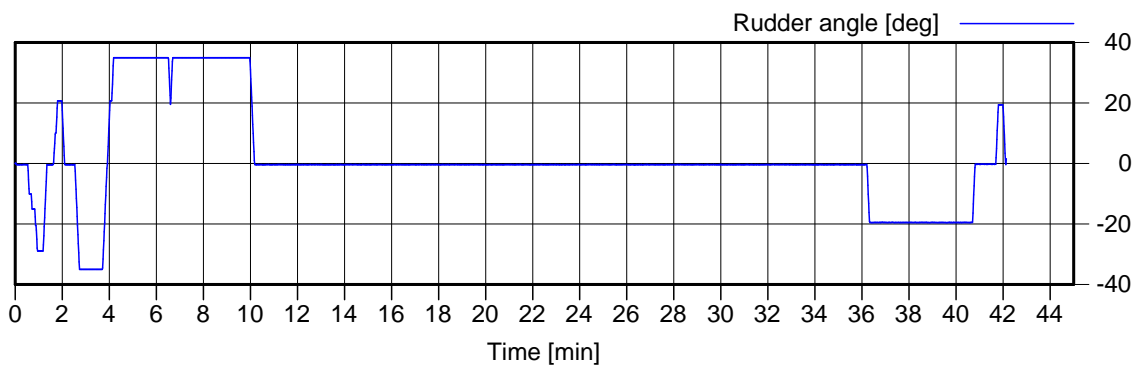
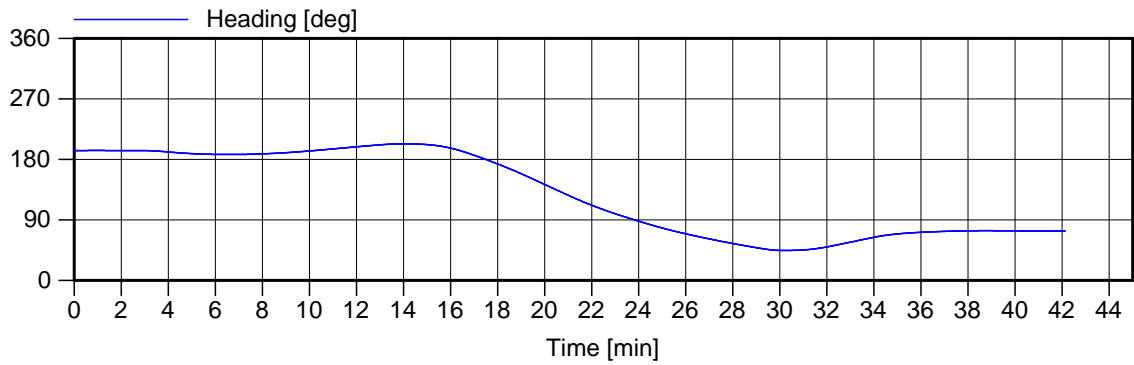

Ship data 1

Ship: Capesize 292x45x18.5

Current: Slack LW

Run: 17-12 Arr

Wind: SSW 15.5 m/s

Figure: 12.c

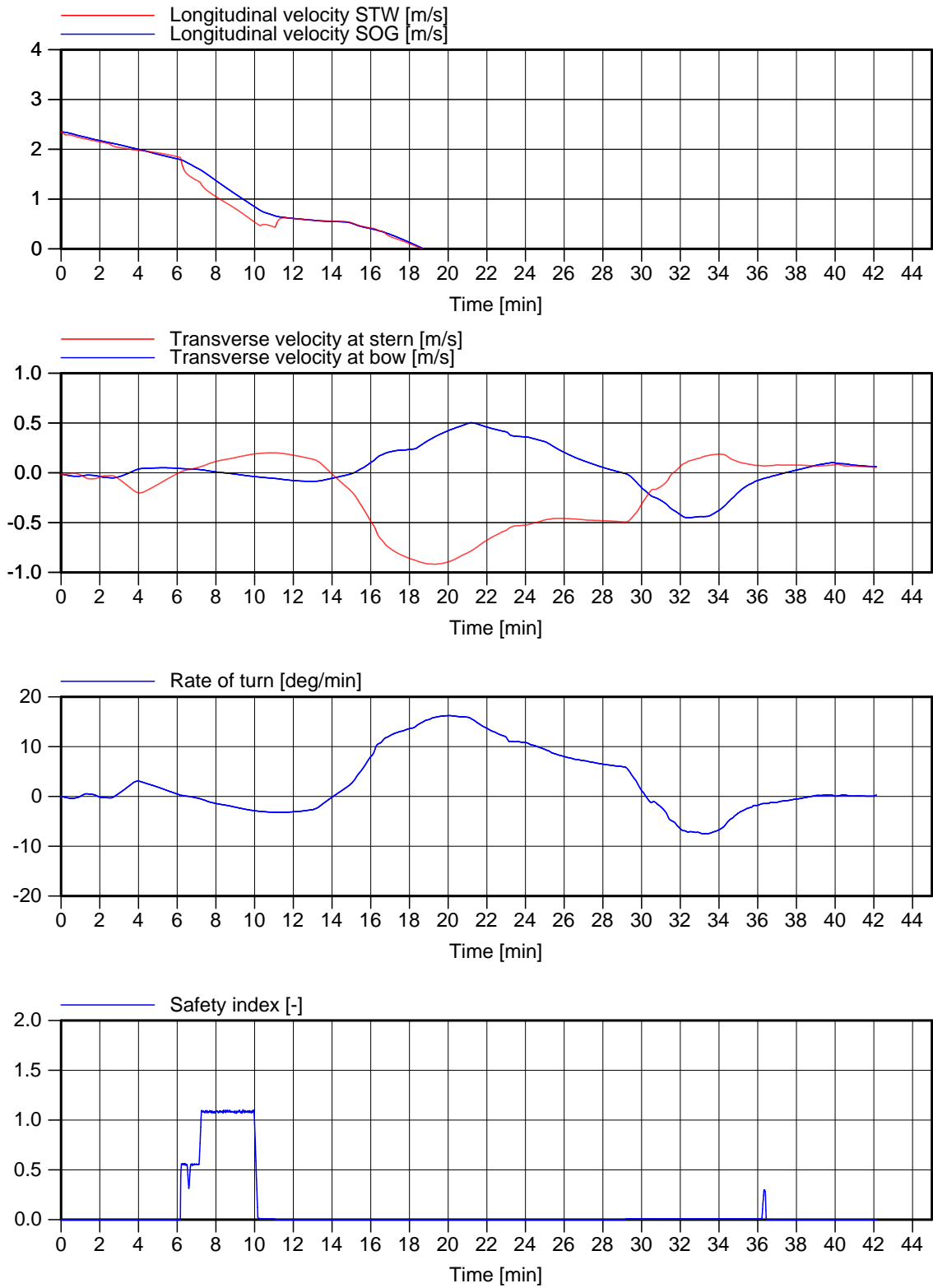

Ship data 2

Ship: Capesize 292x45x18.5

Current: Slack LW

Run: 17-12 Arr

Wind: SSW 15.5 m/s

Figure: 12.d

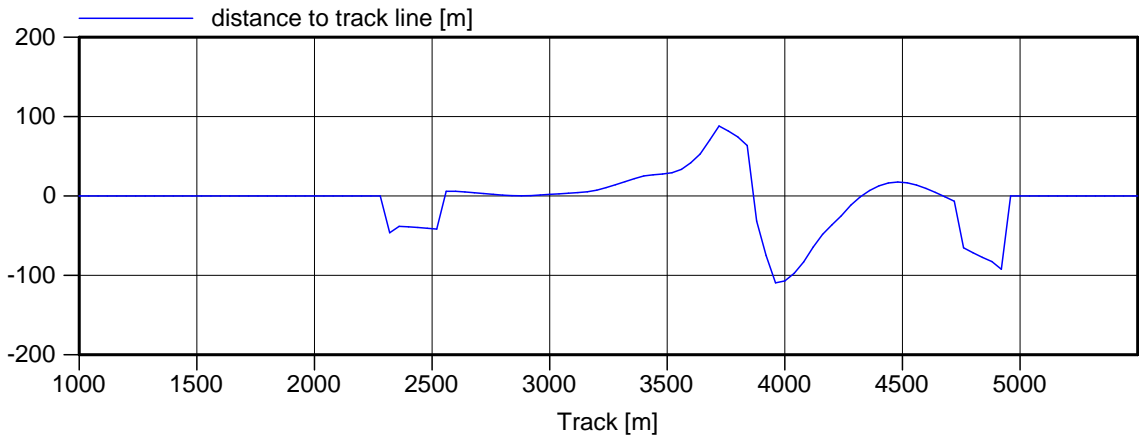
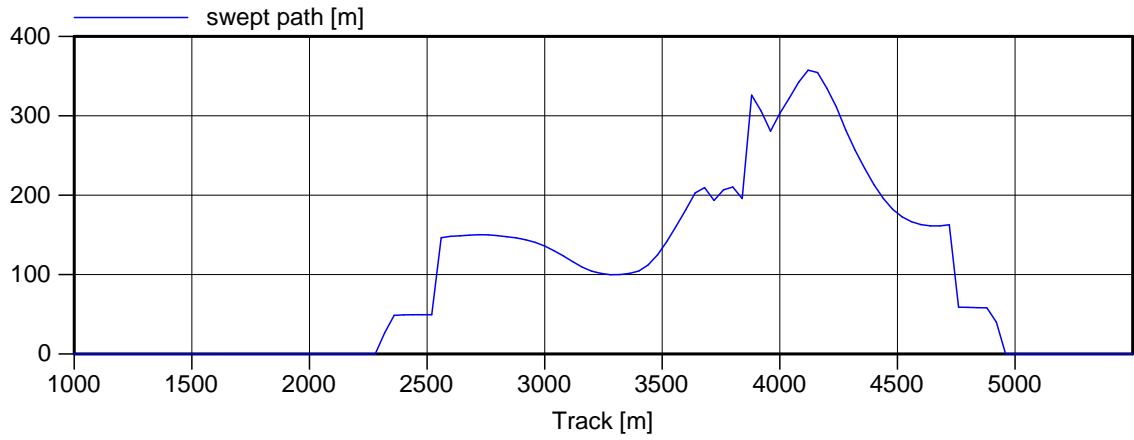

Space used	Run: 17-12 Arr
Ship: Capesize 292x45x18.5	Wind: SSW 15.5 m/s
Current: Slack LW	Figure: 12.e

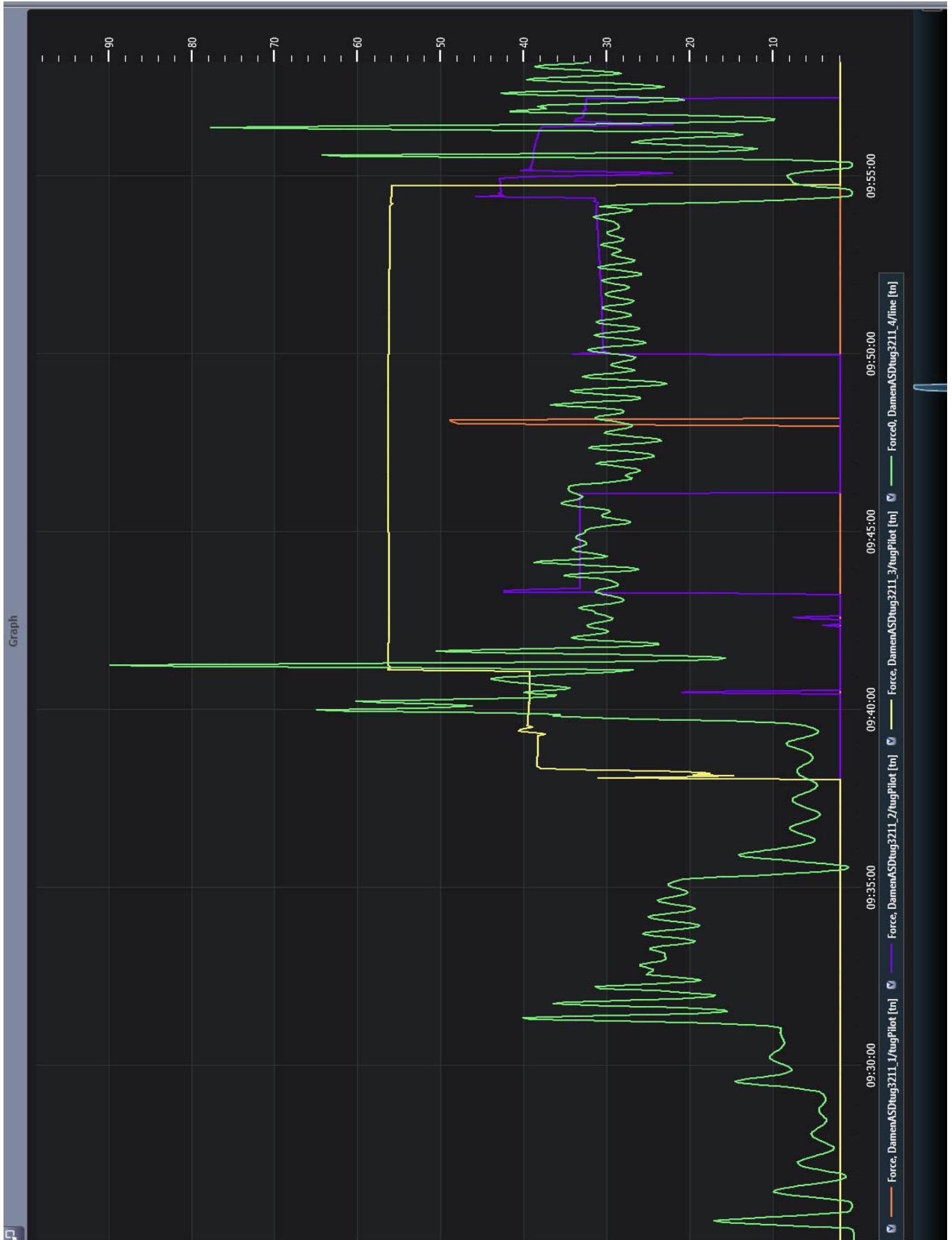

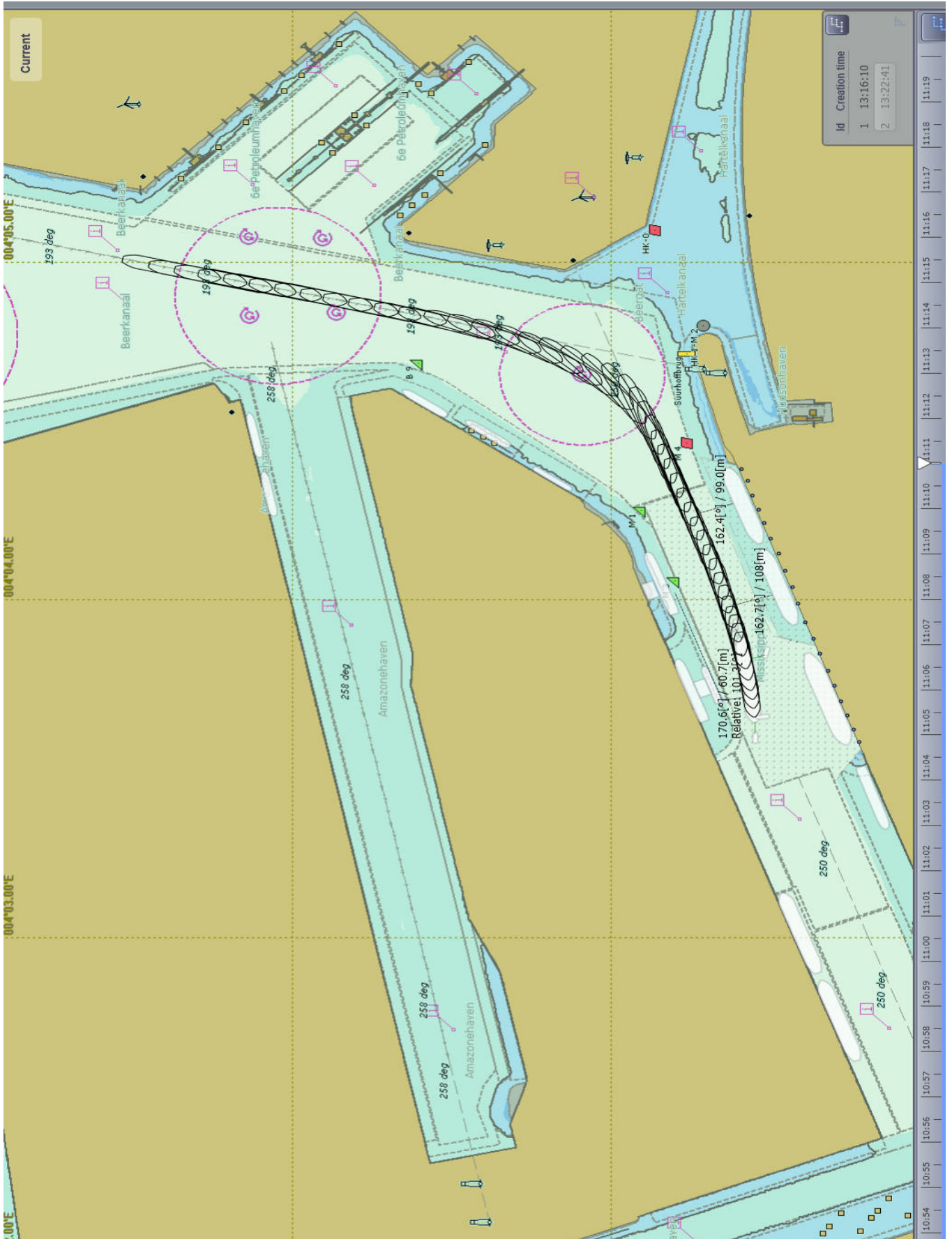

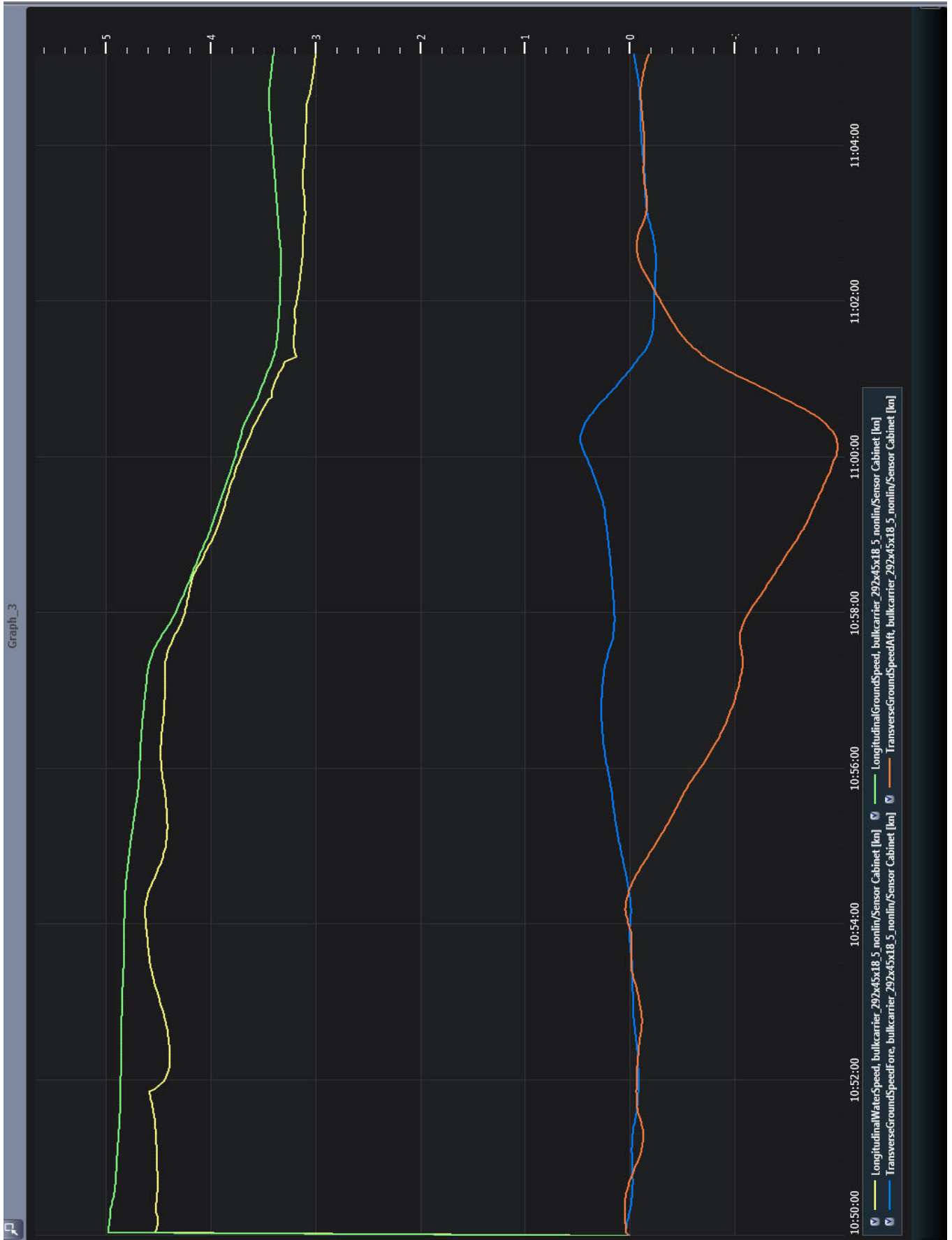



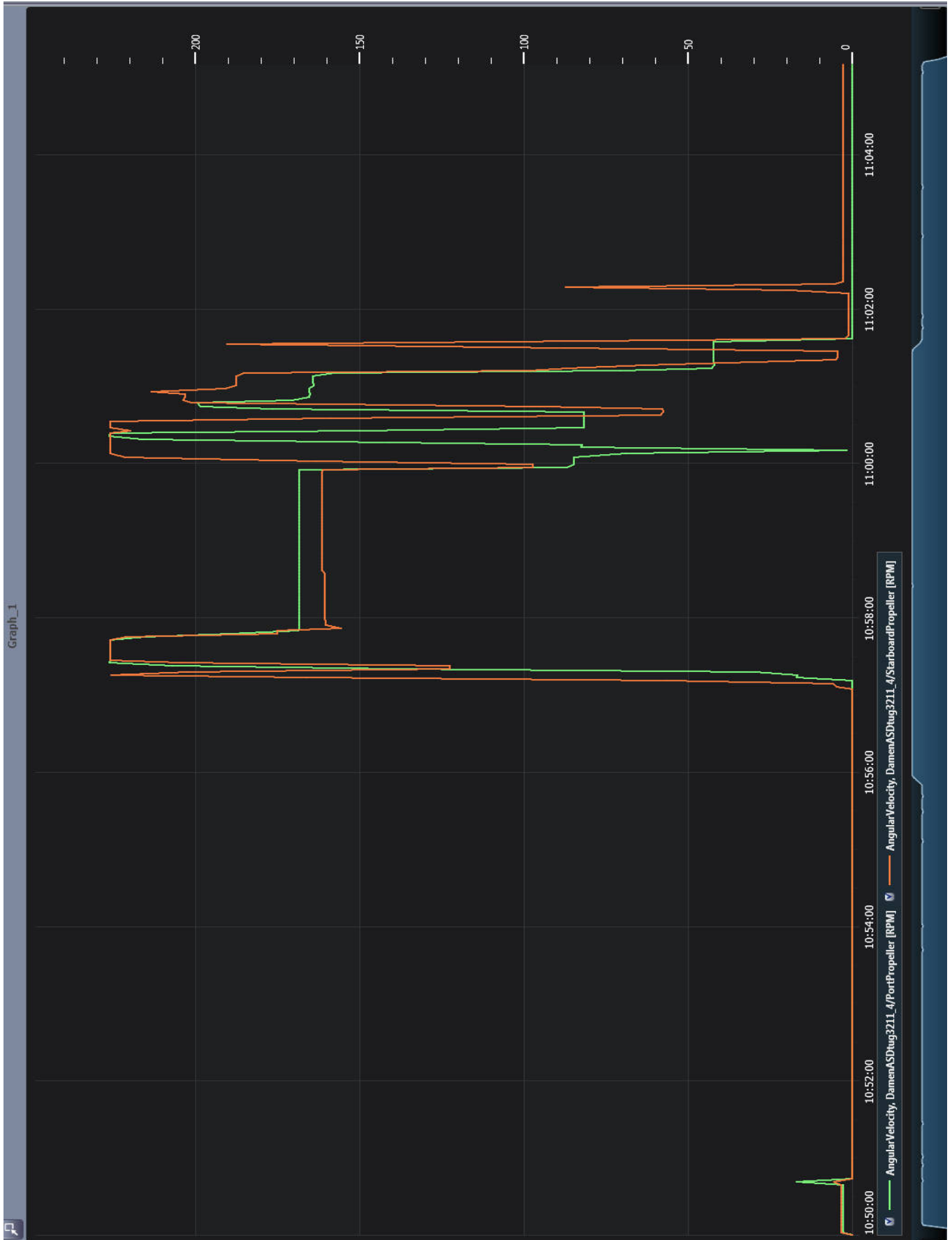

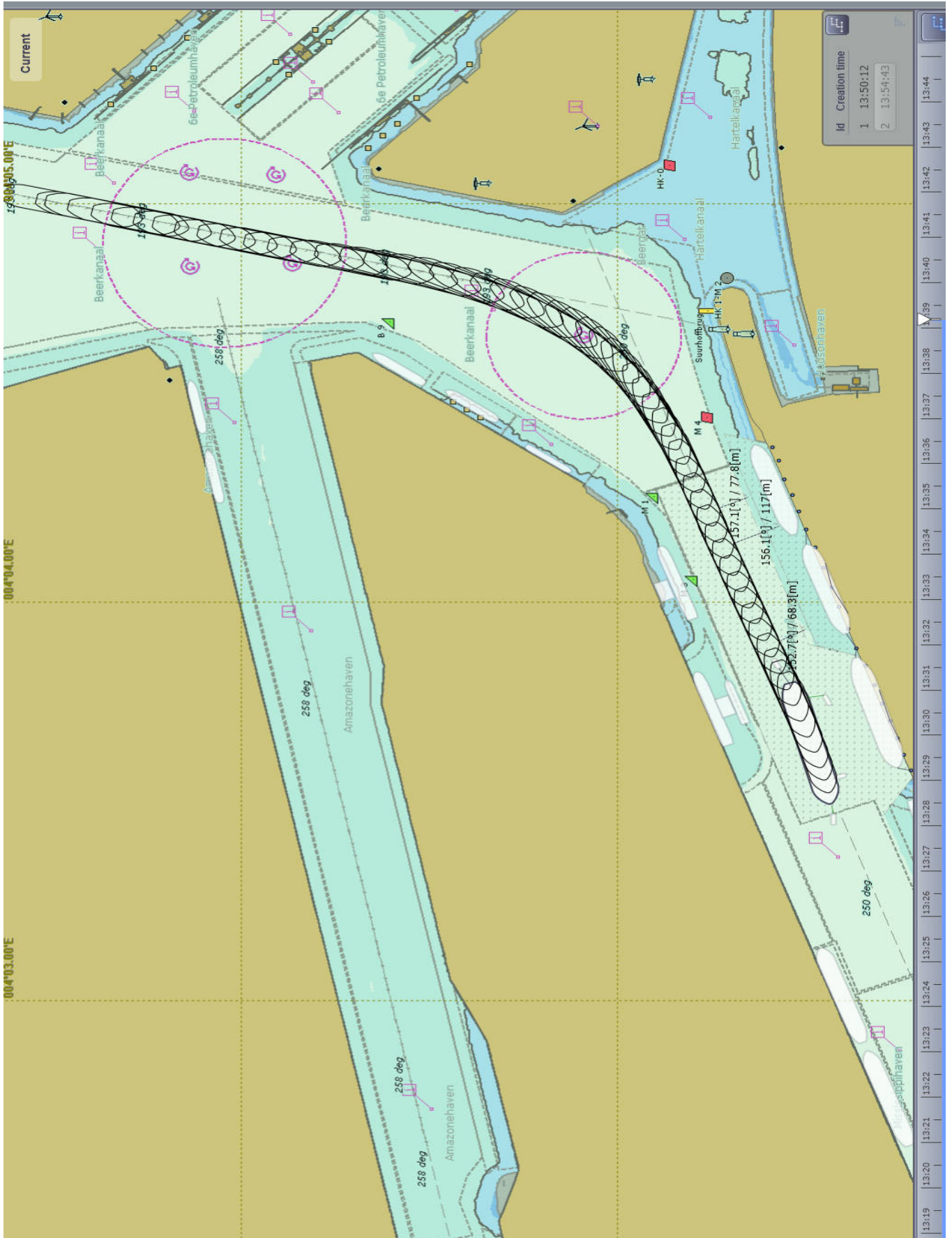

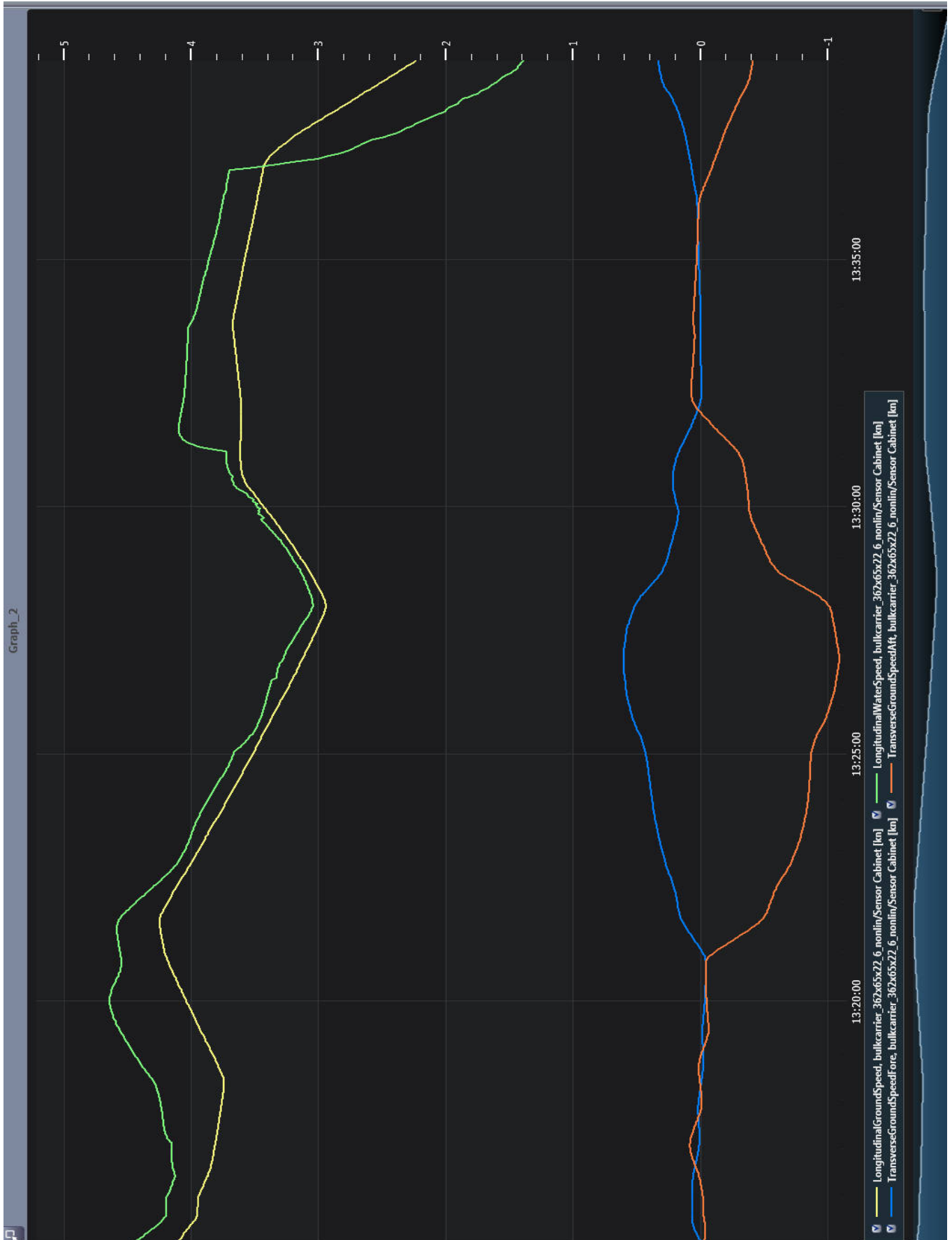

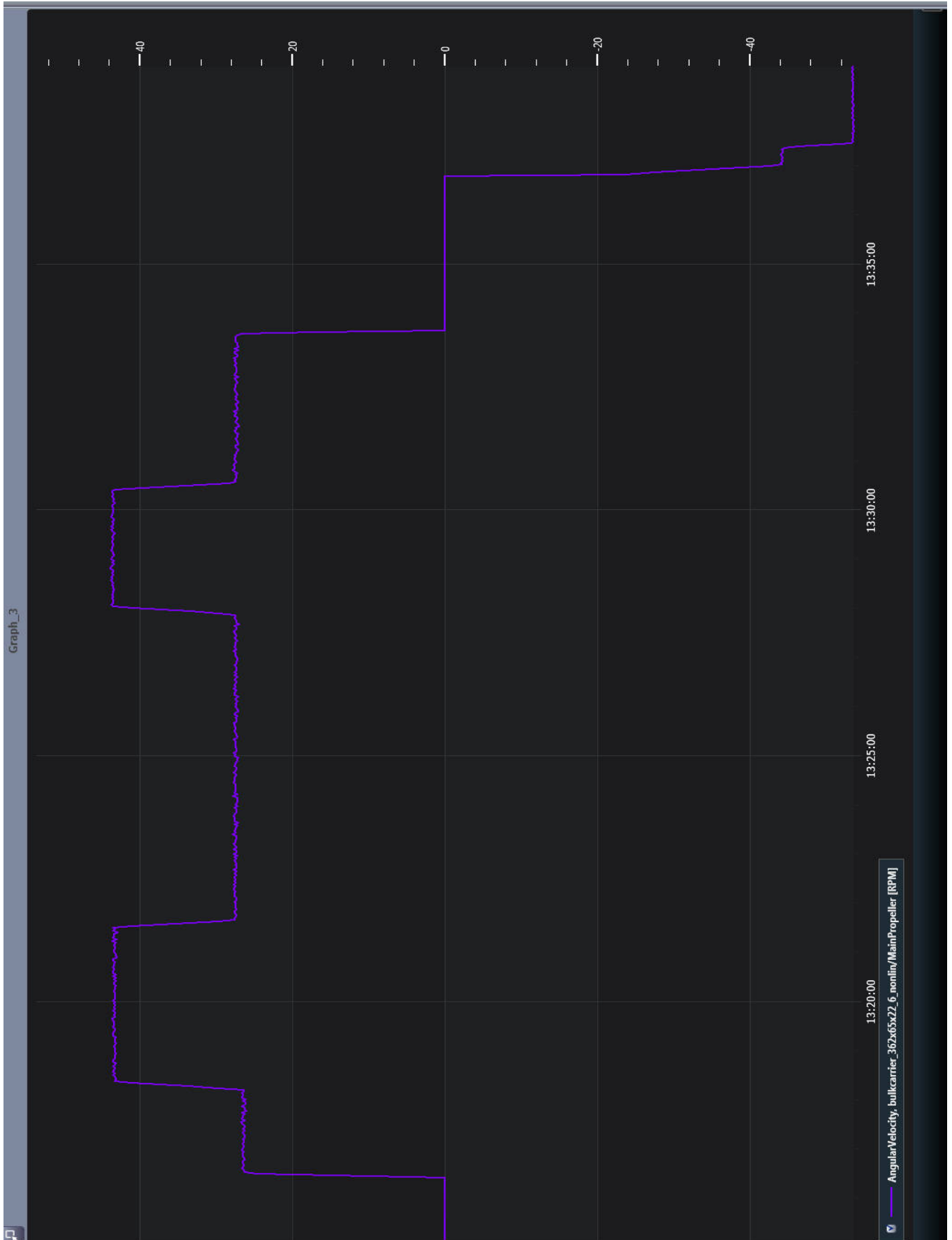

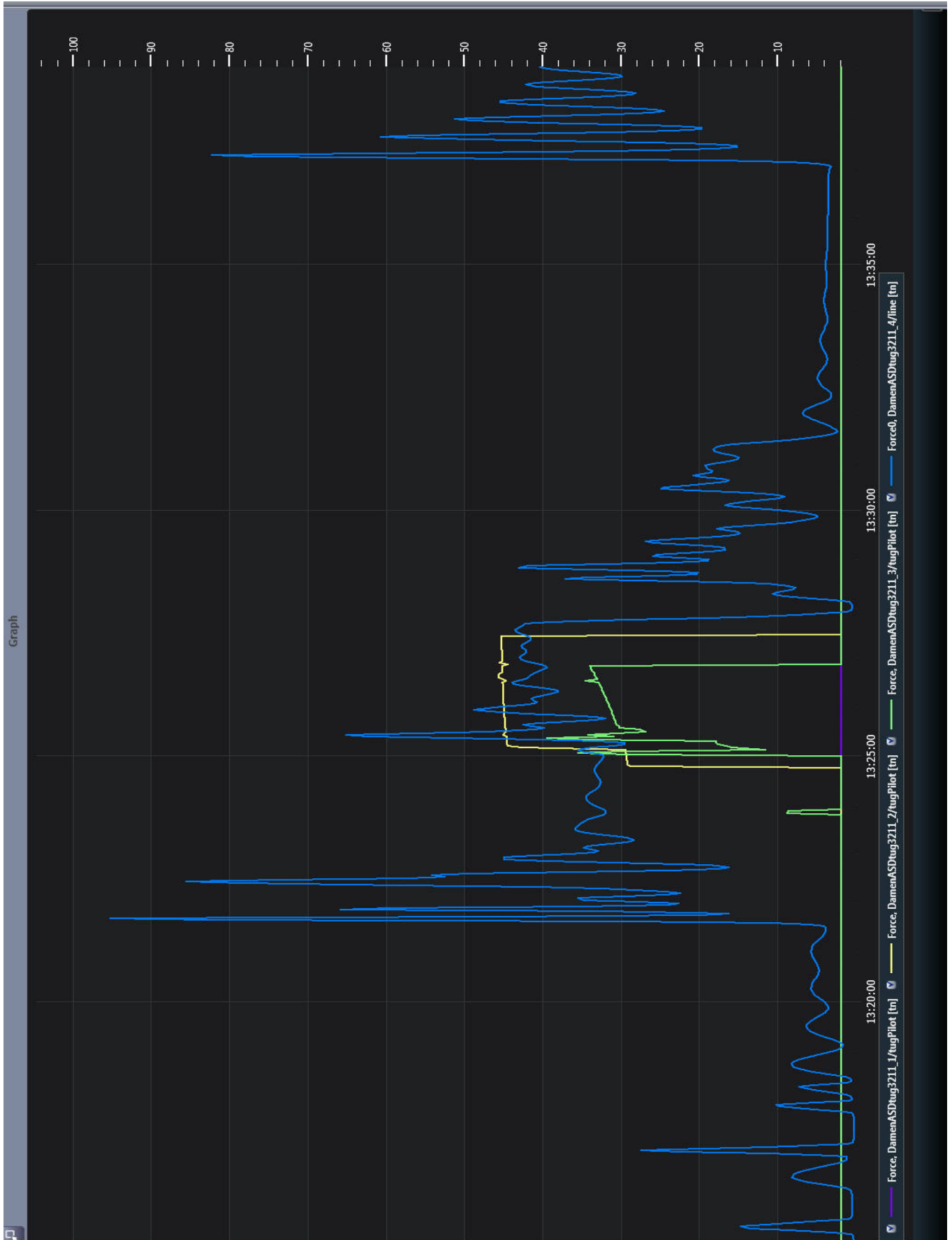

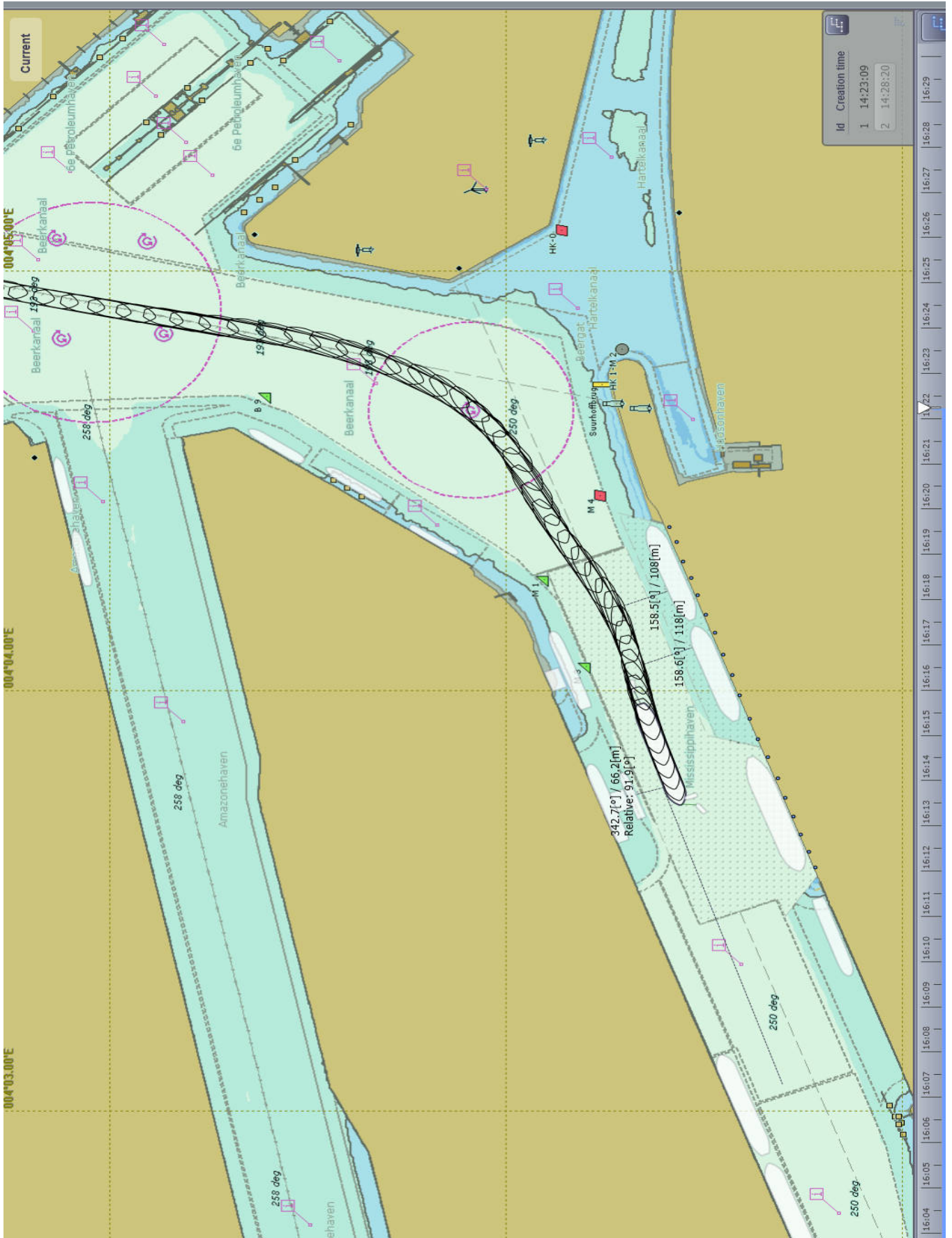

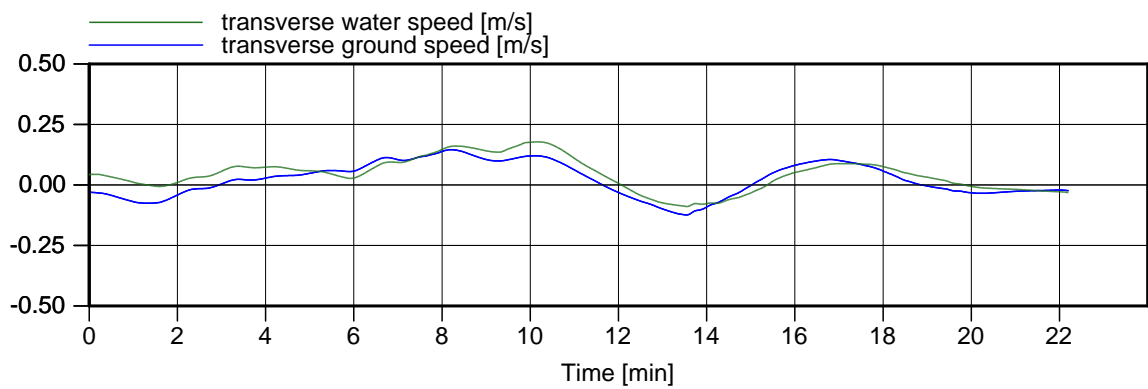
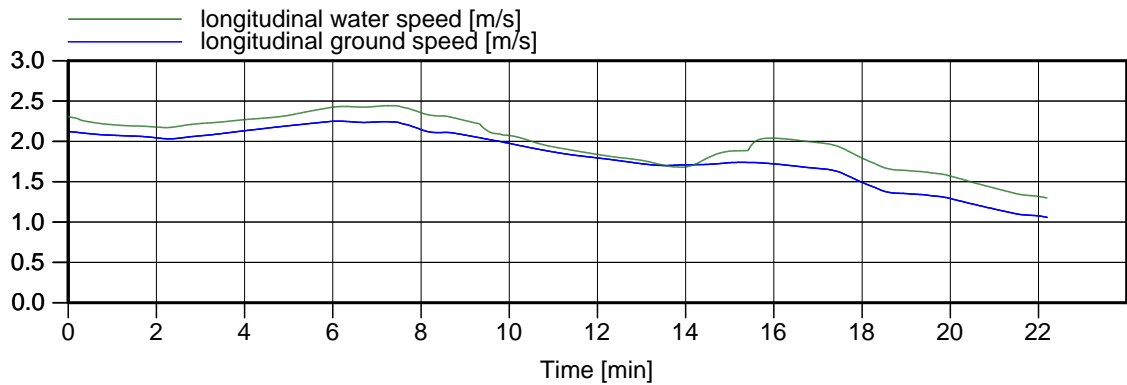
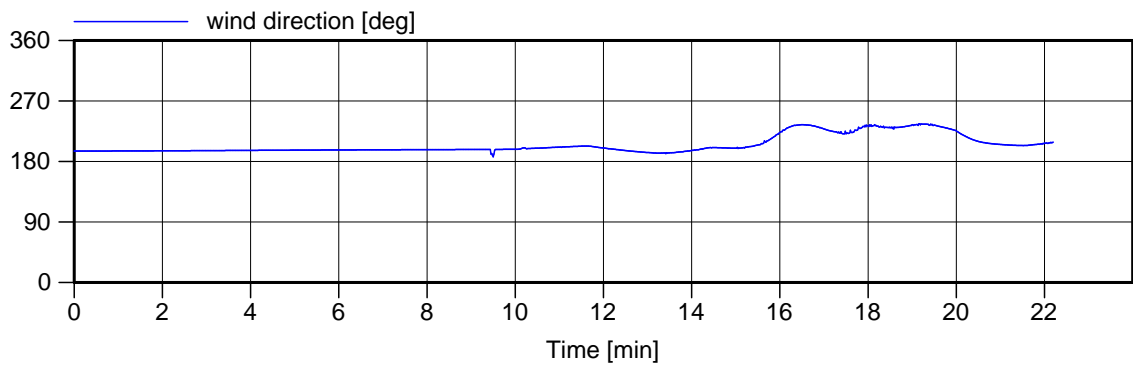
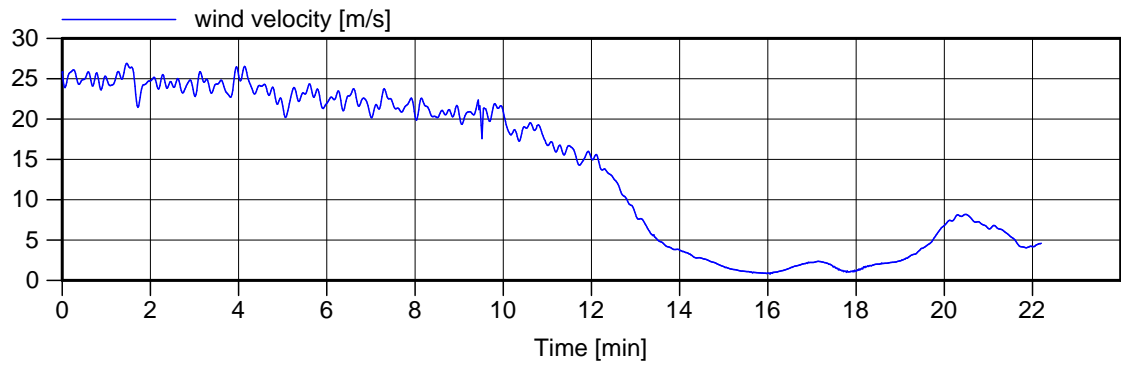

Environment

Run: 17-15 Arr

Ship: Capesize 292x45x18.5

Wind: SSW 15.5 m/s

Current: Ebb max

Figure: 15.b

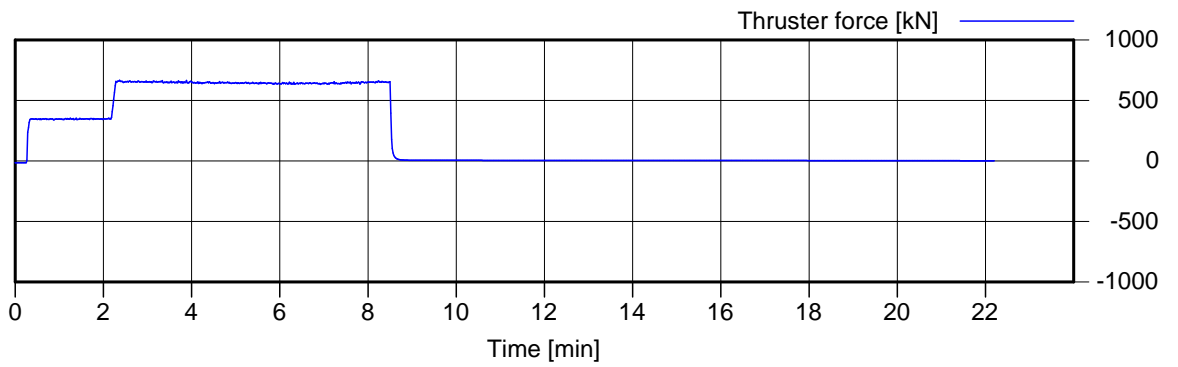
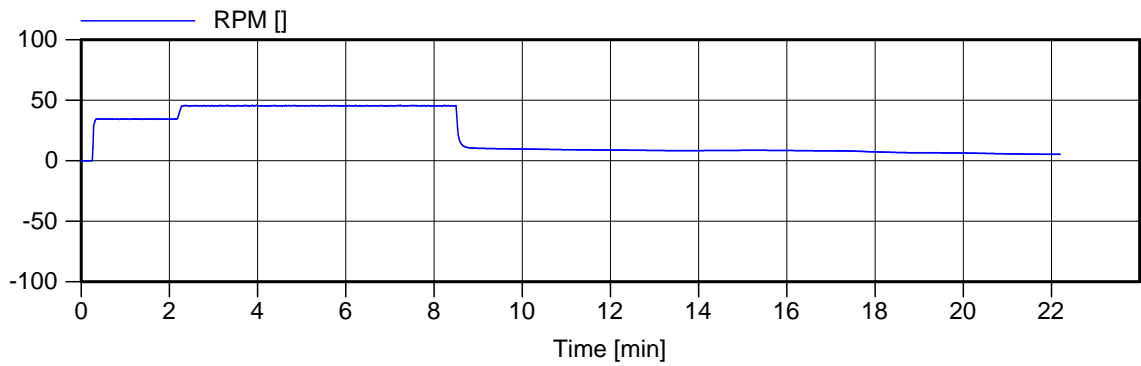
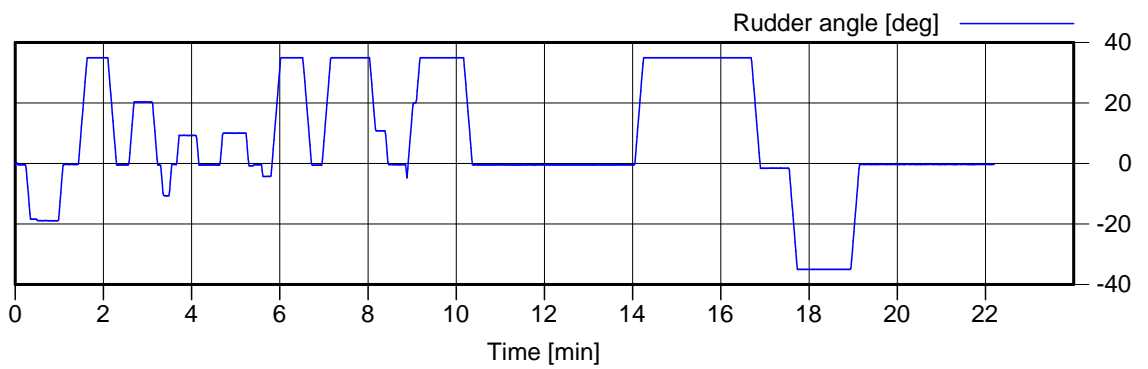
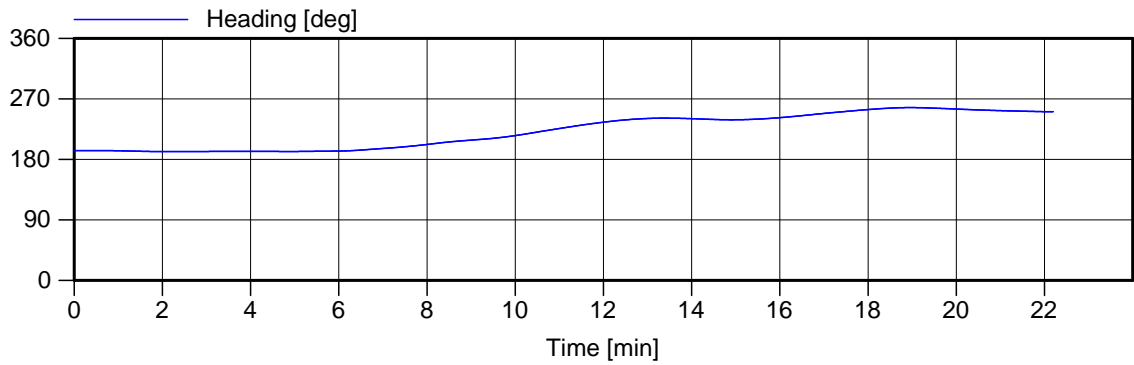

Ship data 1

Ship: Capesize 292x45x18.5

Current: Ebb max

Run: 17-15 Arr

Wind: SSW 15.5 m/s

Figure: 15.c

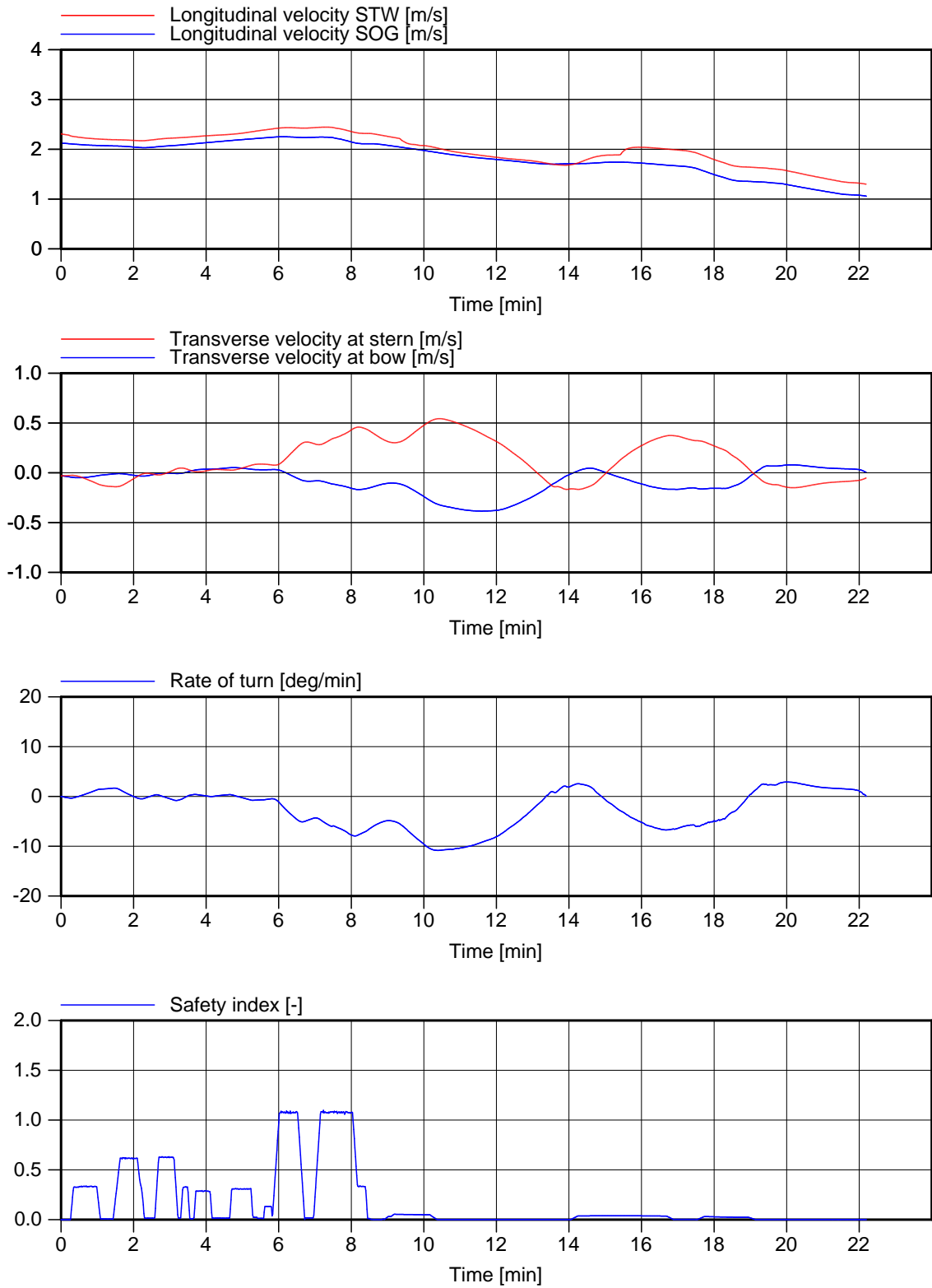

Ship data 2

Ship: Capesize 292x45x18.5

Current: Ebb max

Run: 17-15 Arr

Wind: SSW 15.5 m/s

Figure: 15.d

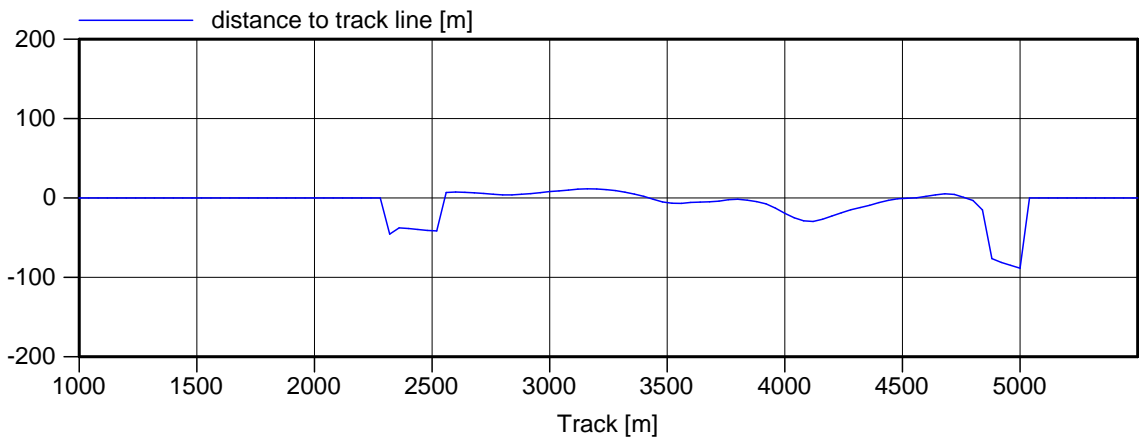
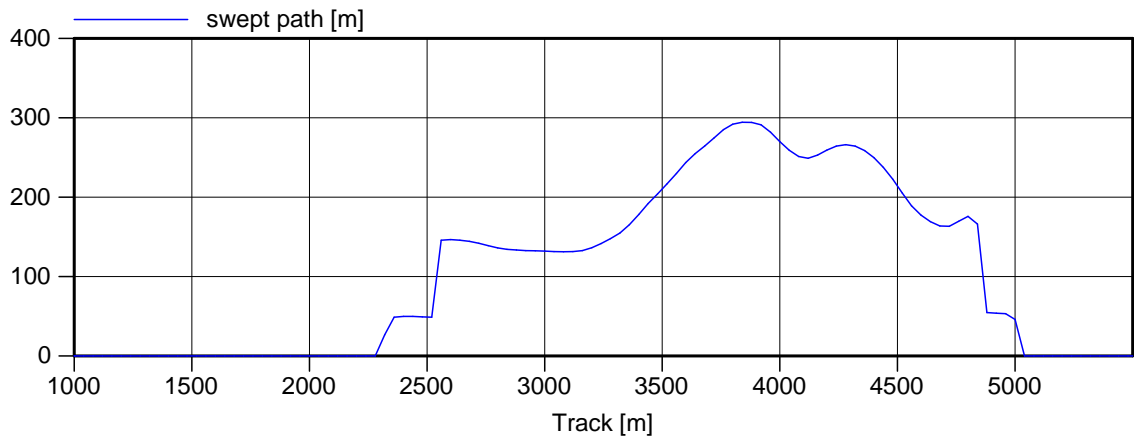

Space used	Run: 17-15 Arr
Ship: Capesize 292x45x18.5	Wind: SSW 15.5 m/s
Current: Ebb max	Figure: 15.e

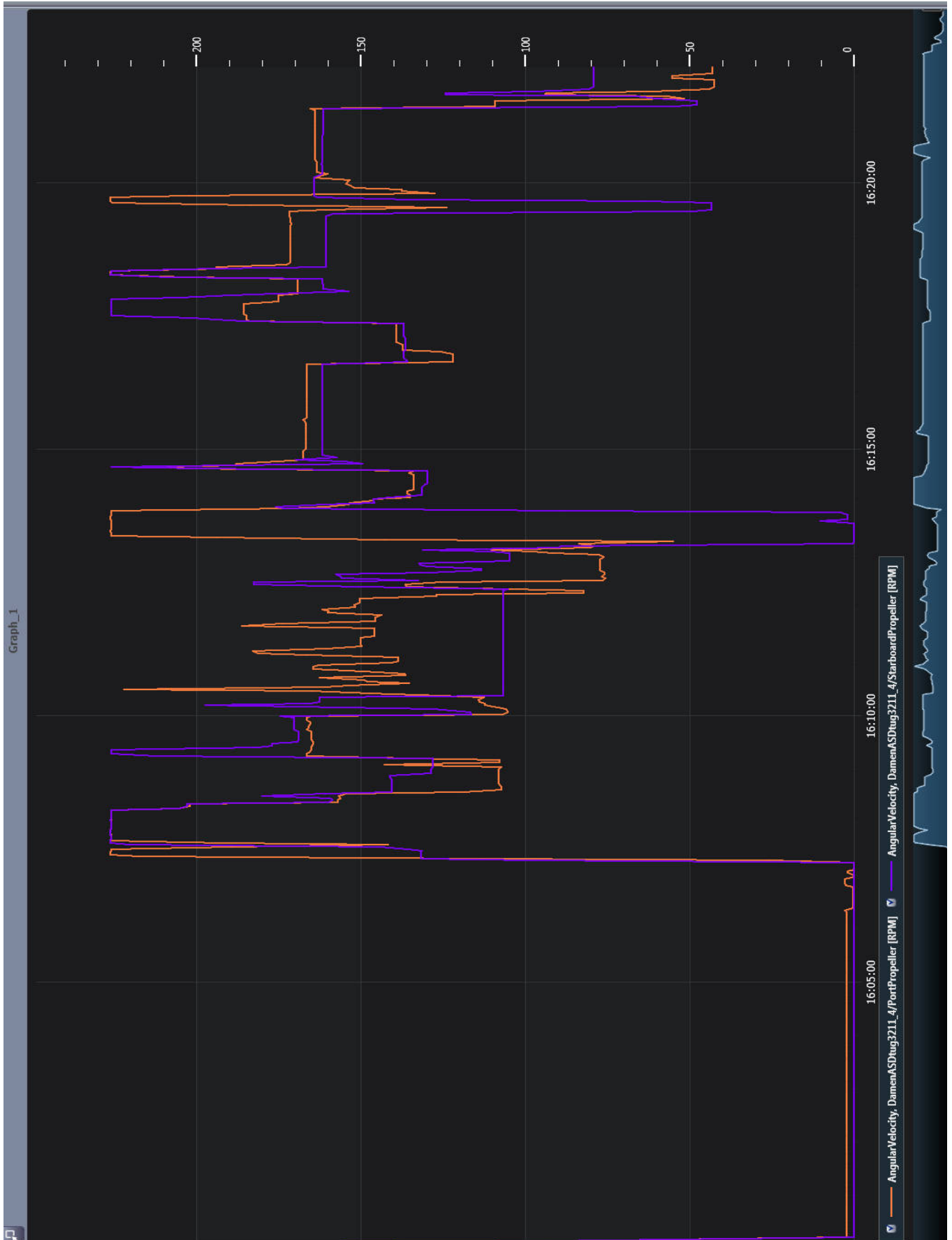

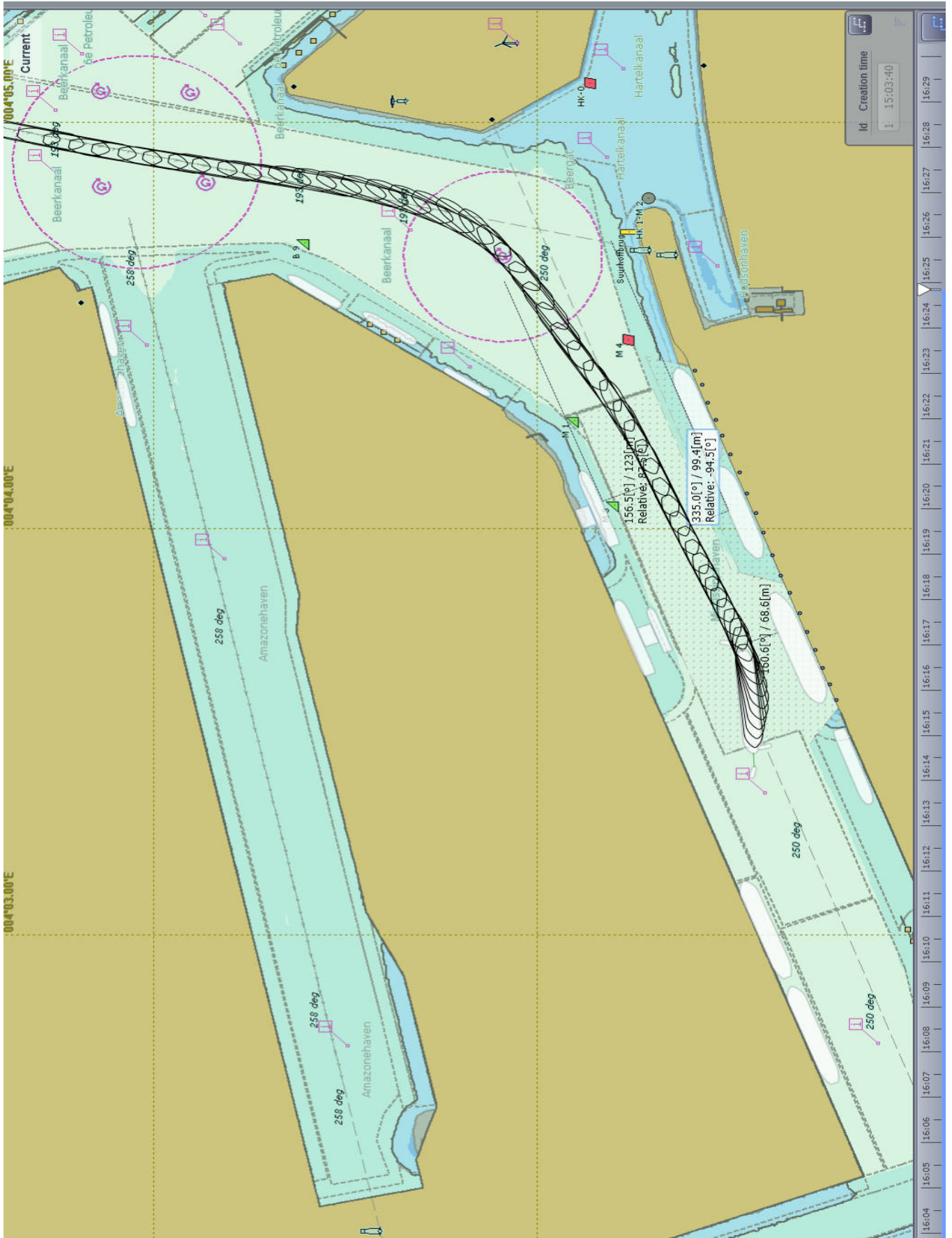

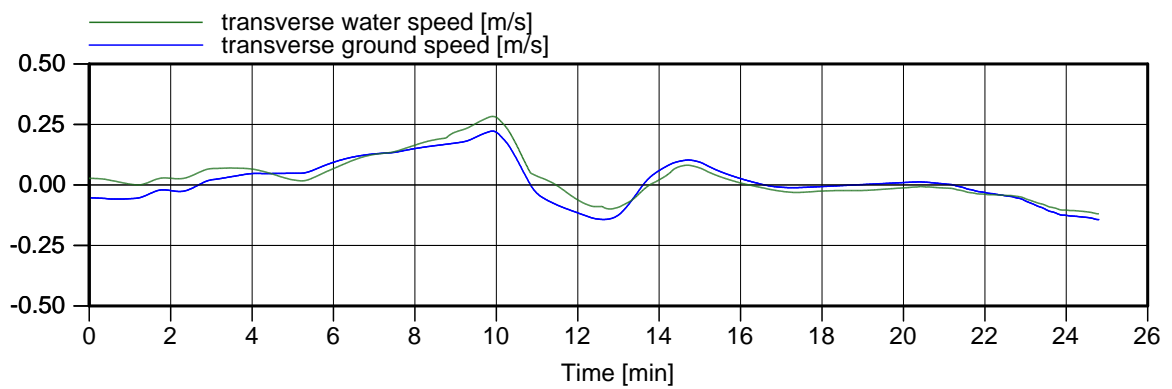
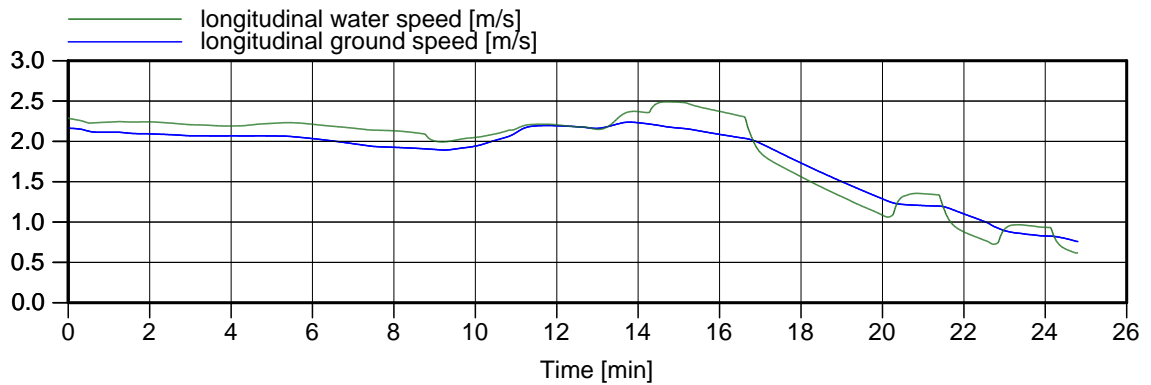
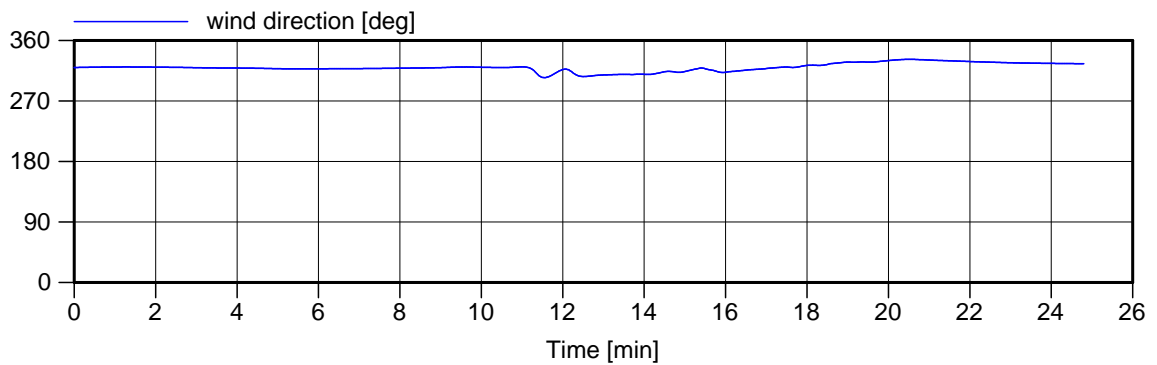
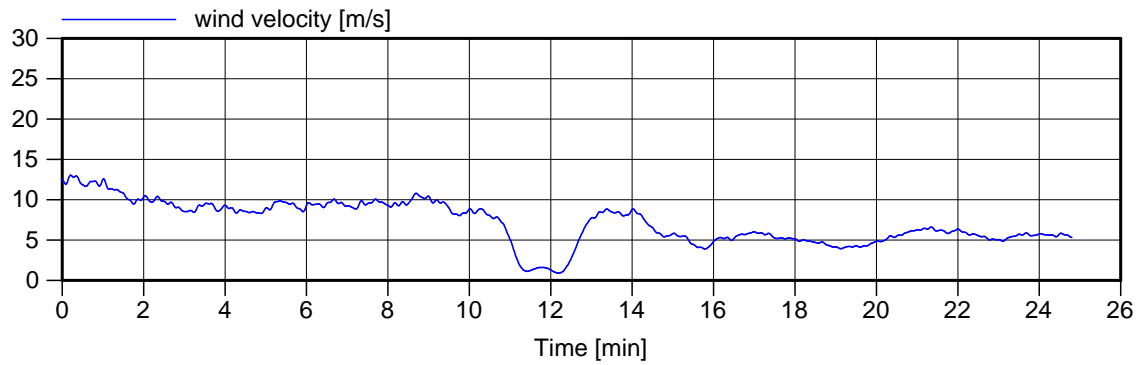

Environment

Run: 17-16 Arr

Ship: Capesize 292x45x18.5

Wind: NW 15.5 m/s

Current: Ebb max

Figure: 16.b

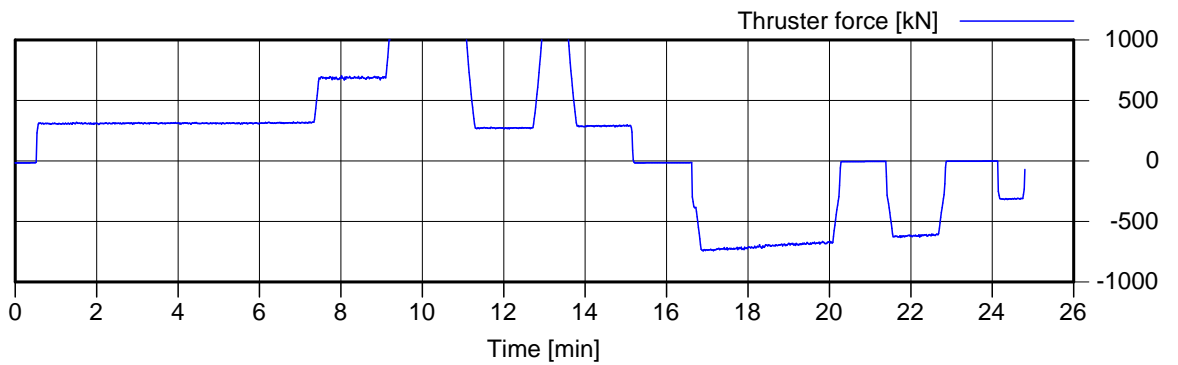
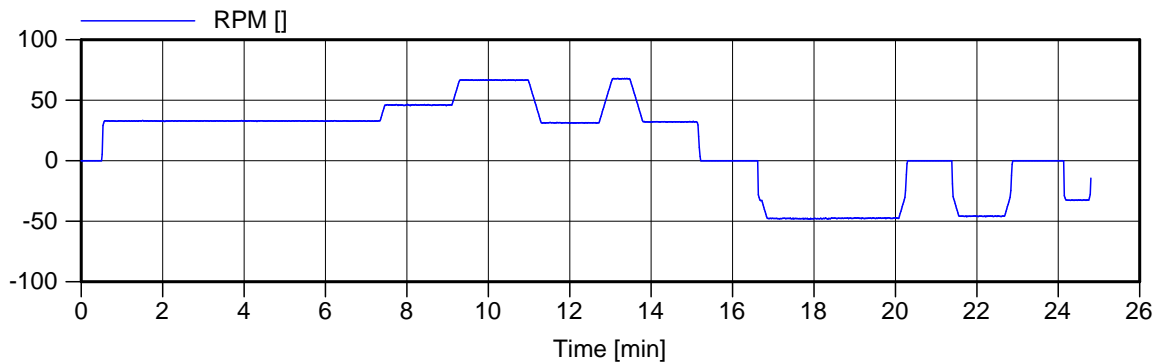
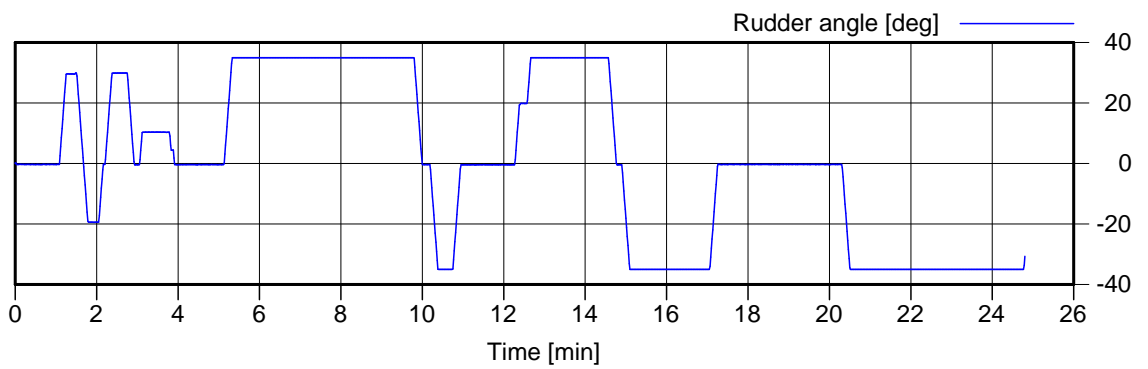
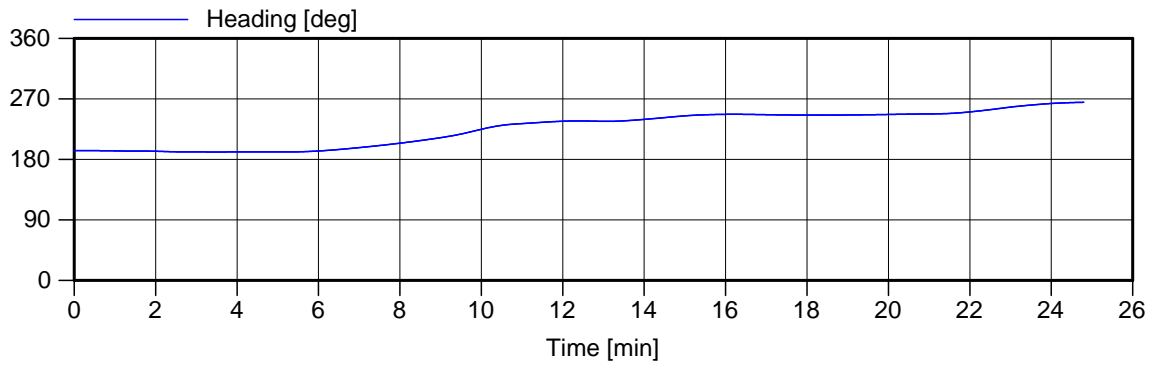

Ship data 1

Run: 17-16 Arr

Ship: Capesize 292x45x18.5

Wind: NW 15.5 m/s

Current: Ebb max

Figure: 16.c

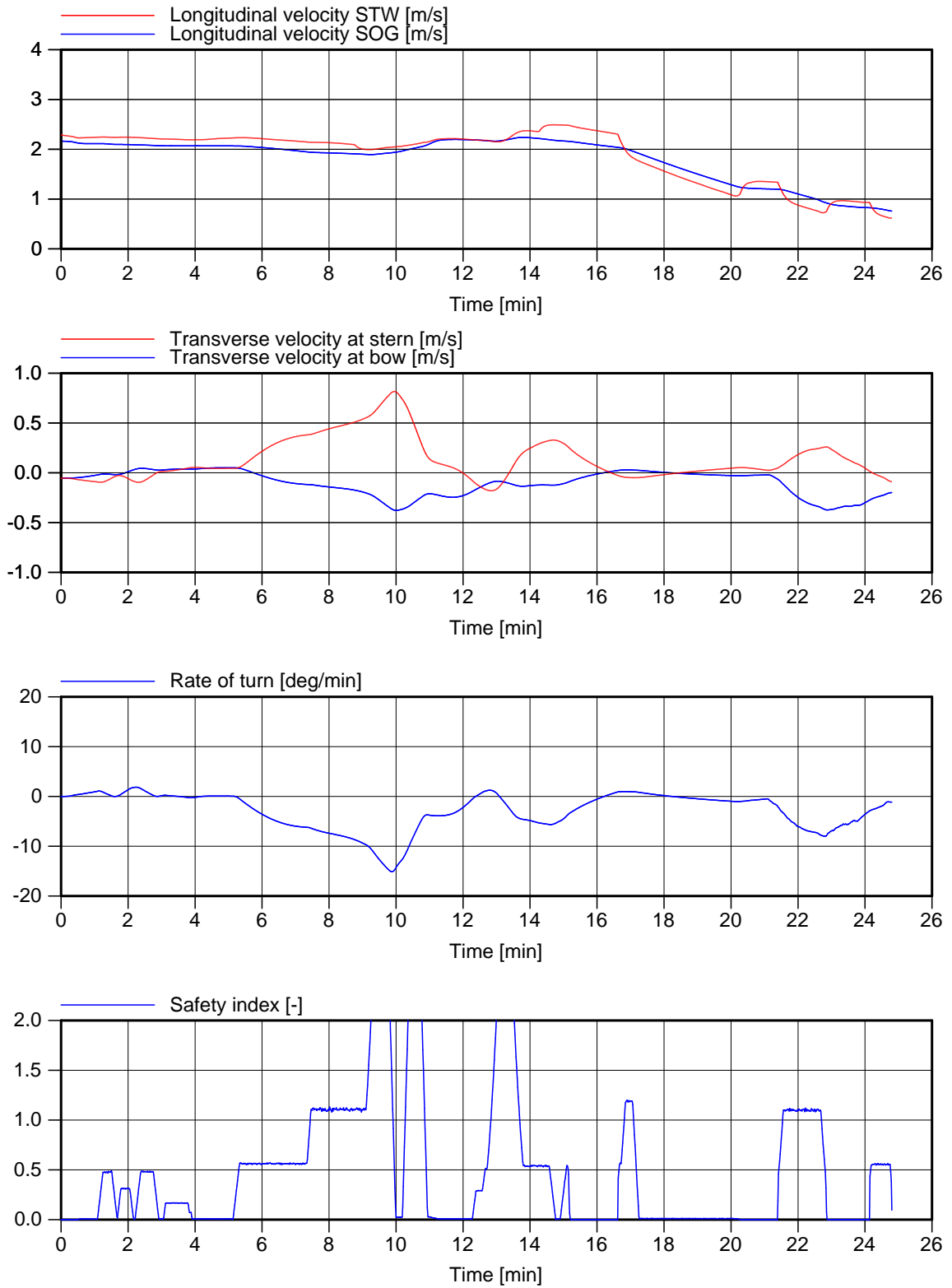

Ship data 2

Ship: Capesize 292x45x18.5

Current: Ebb max

Run: 17-16 Arr

Wind: NW 15.5 m/s

Figure: 16.d

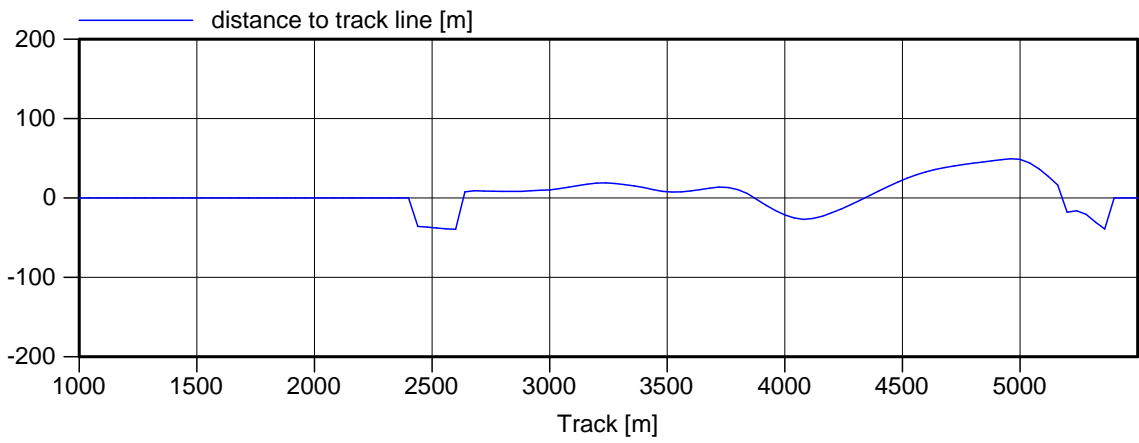
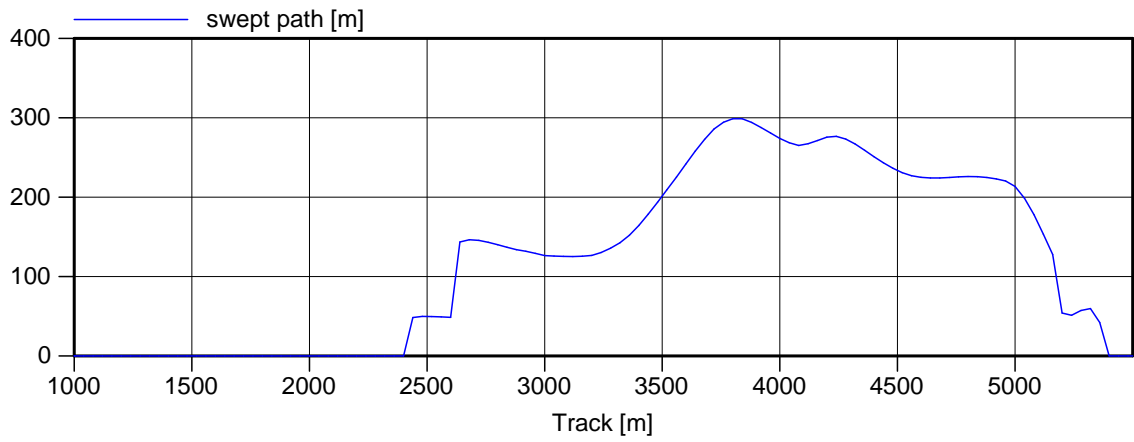

Space used	Run: 17-16 Arr
Ship: Capesize 292x45x18.5	Wind: NW 15.5 m/s
Current: Ebb max	Figure: 16.e

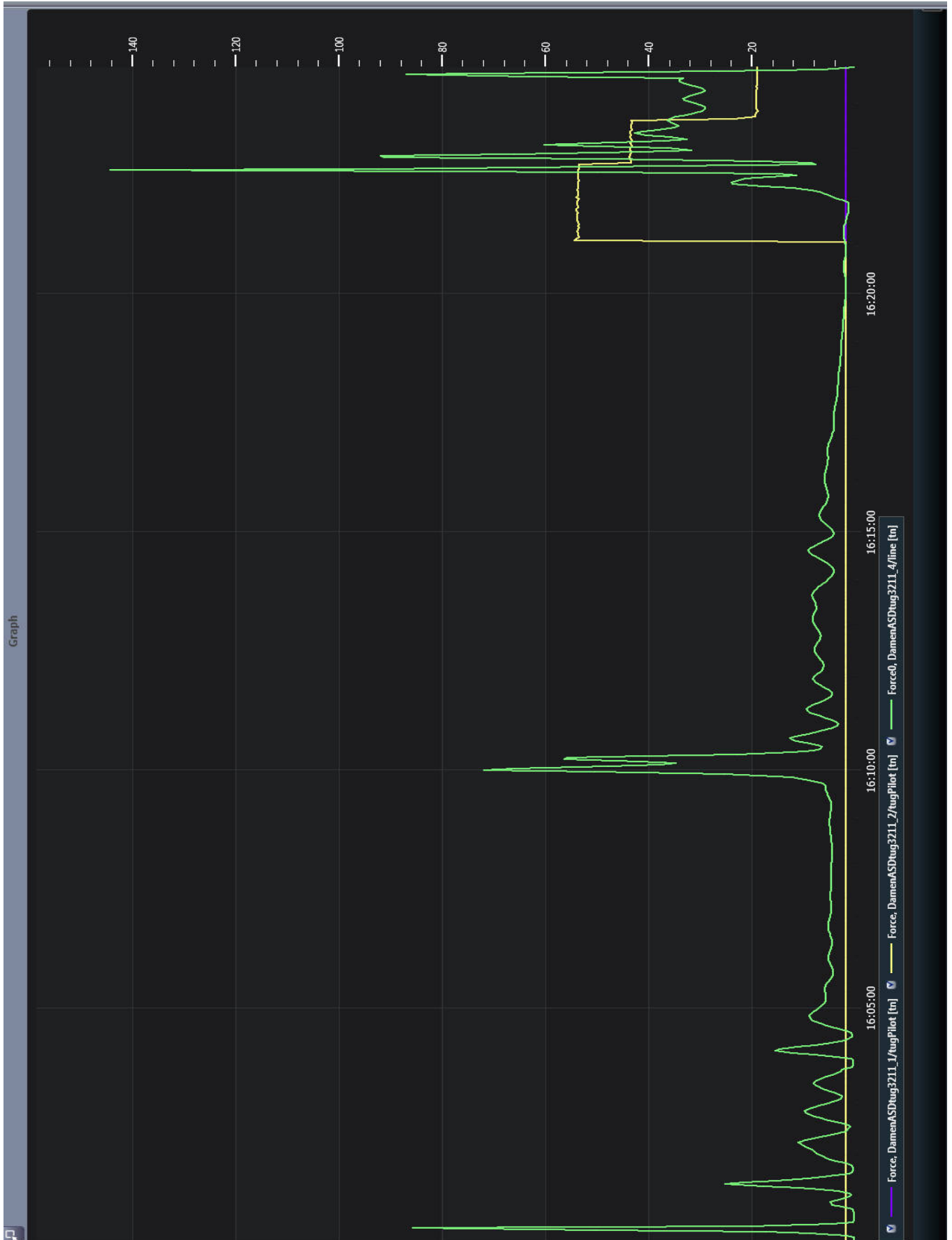

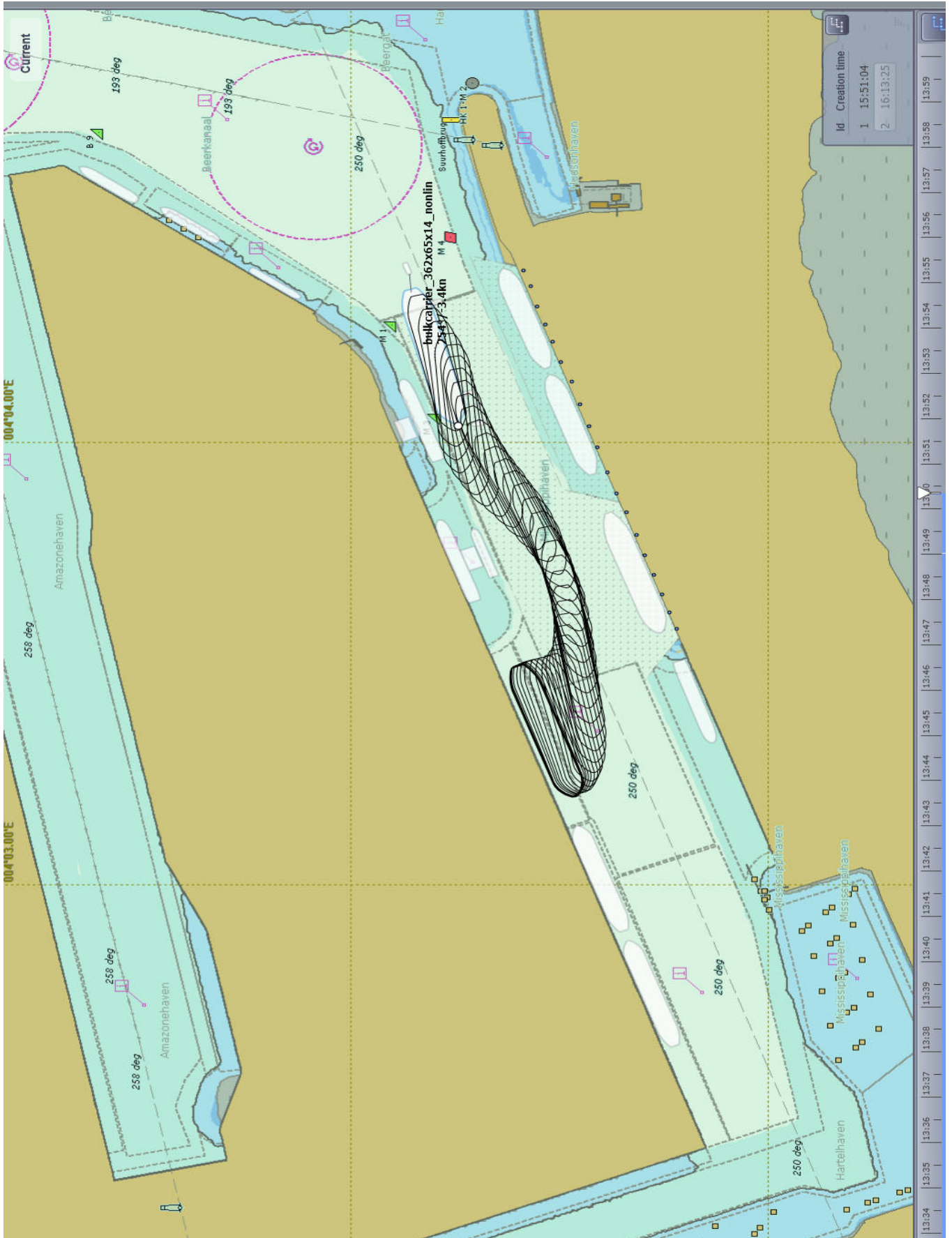

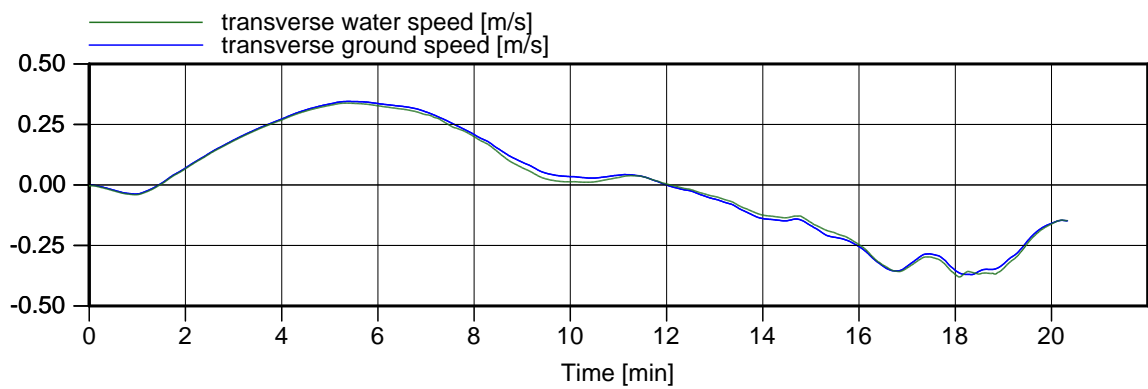
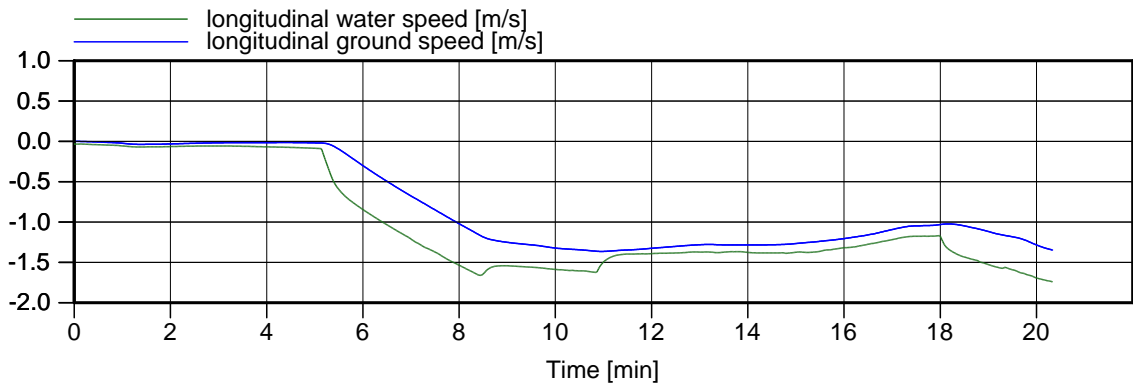
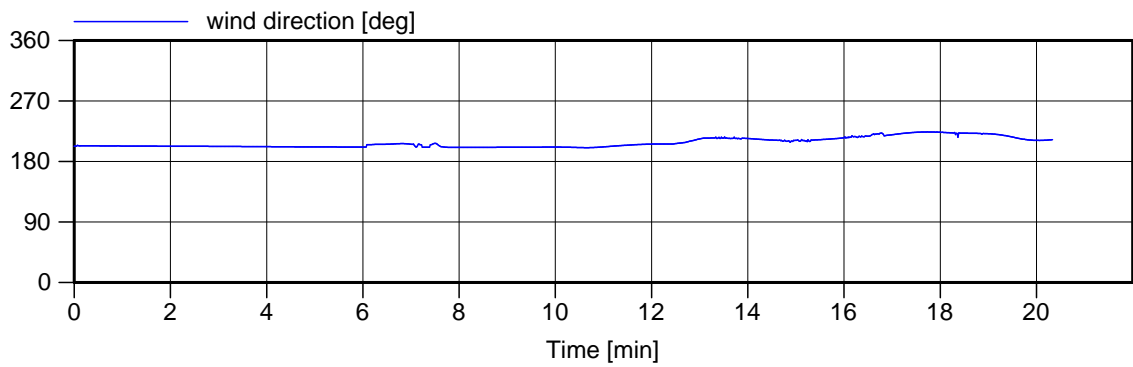
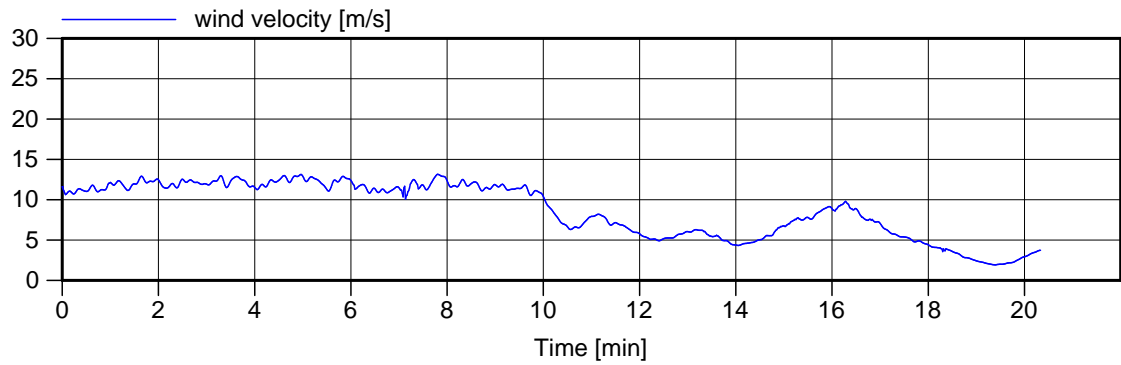

Environment

Run: 17-17 Dep

Ship: Valemax 362x65x14.0

Wind: SSW 15.5 m/s

Current: Slack HW

Figure: 17.b

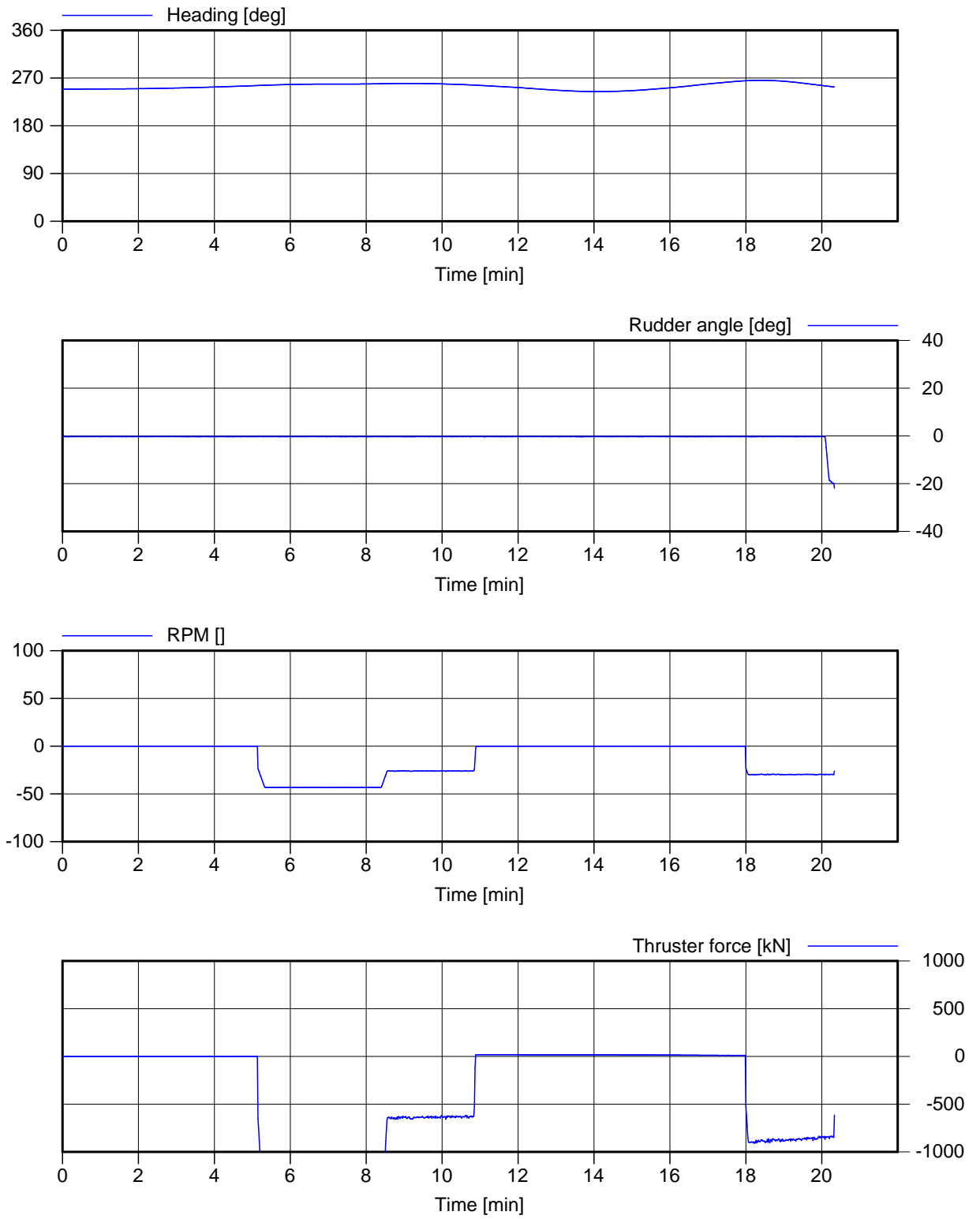

Ship data 1

Ship: Valemax 362x65x14.0

Current: Slack HW

Run: 17-17 Dep

Wind: SSW 15.5 m/s

Figure: 17.c

17_1.c

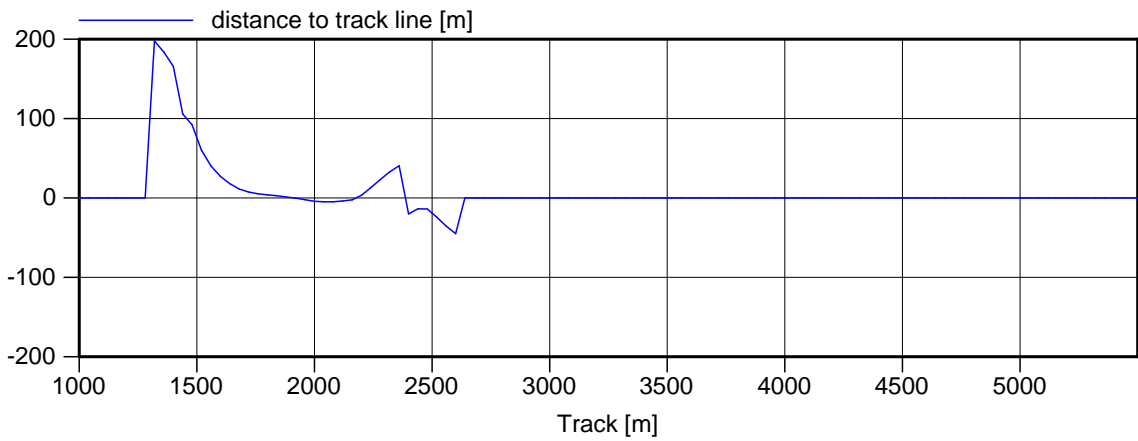
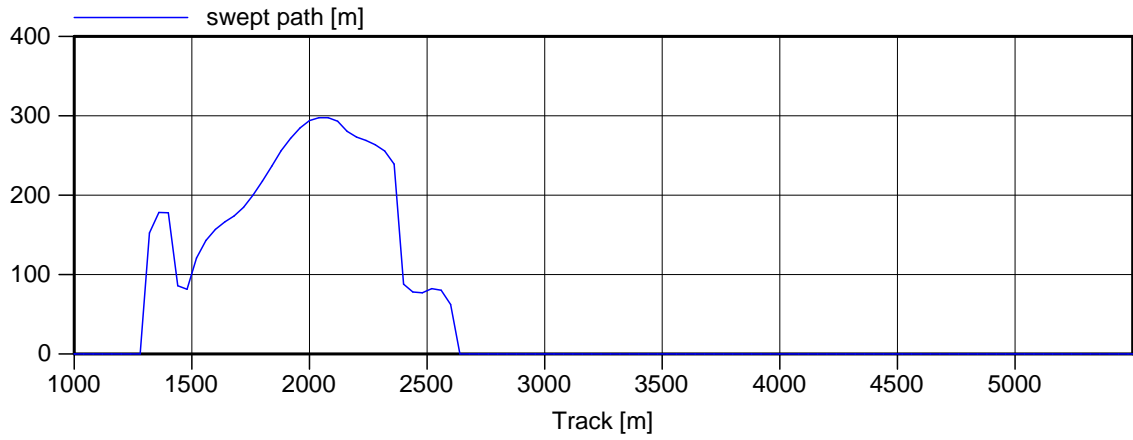

Space used	Run: 17-17 Dep
Ship: Valemax 362x65x14.0	Wind: SSW 15.5 m/s
Current: Slack HW	Figure: 17.e

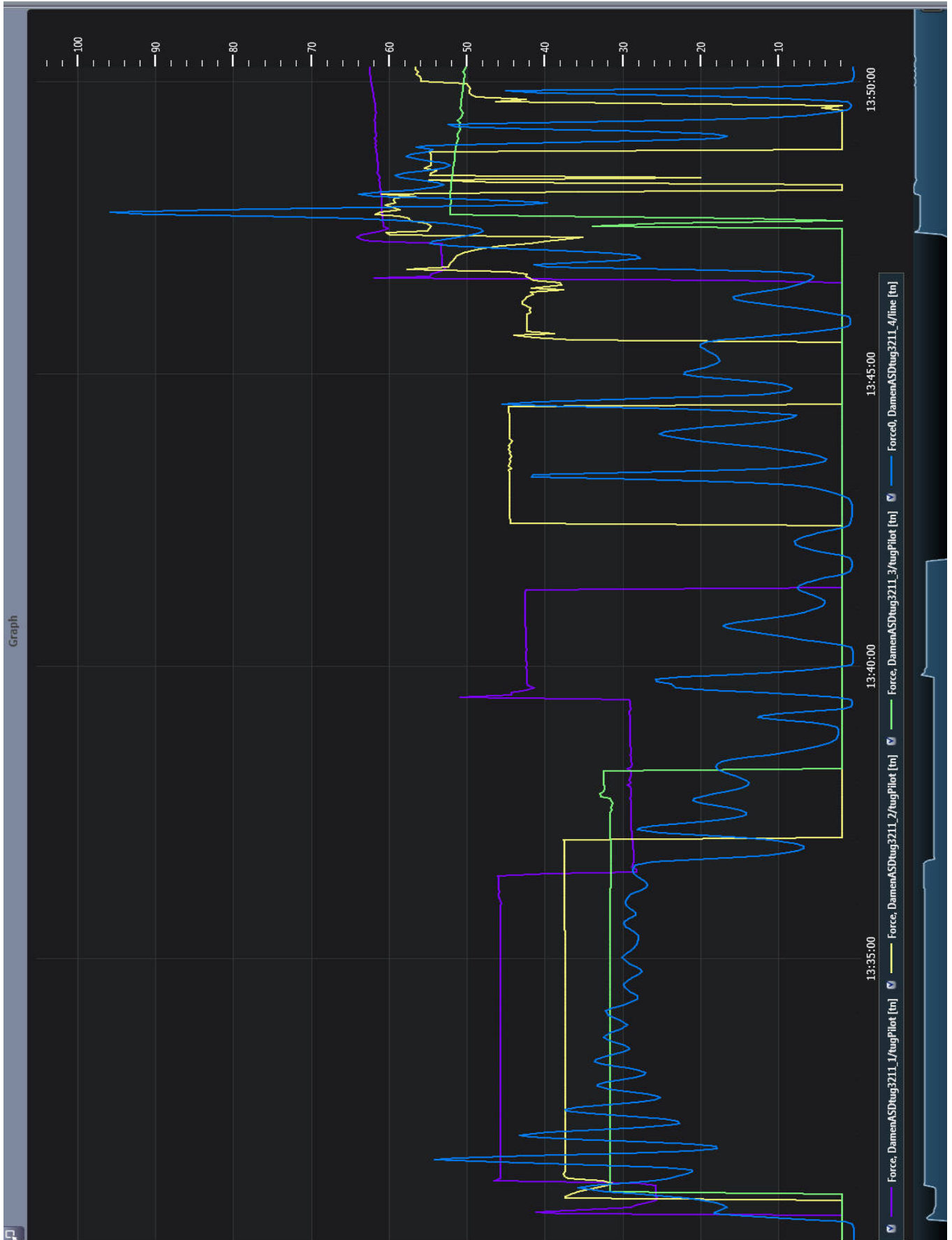

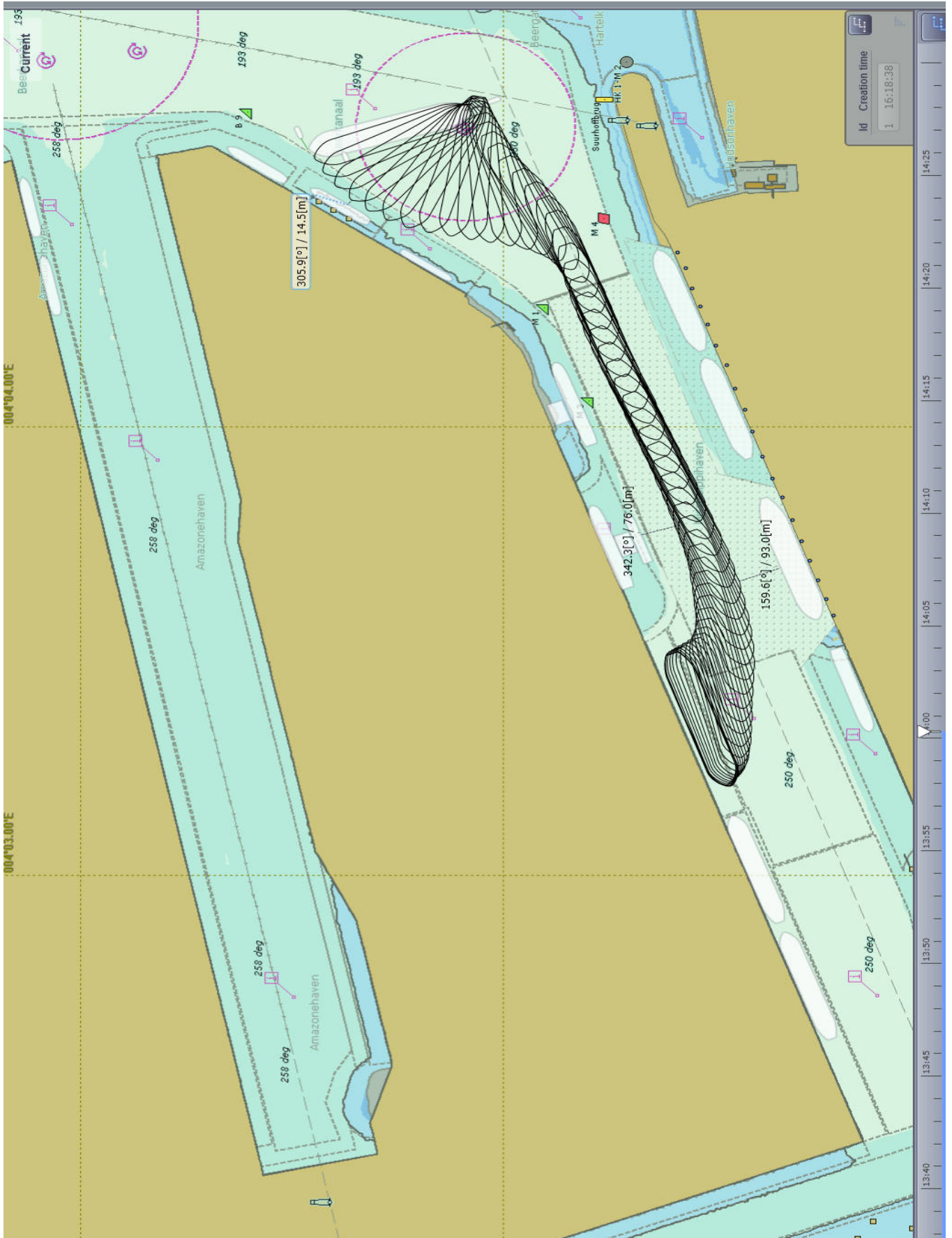

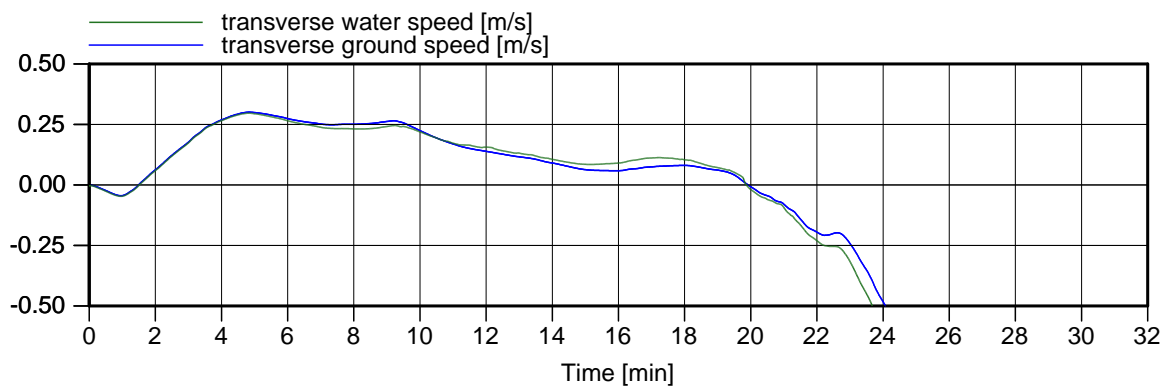
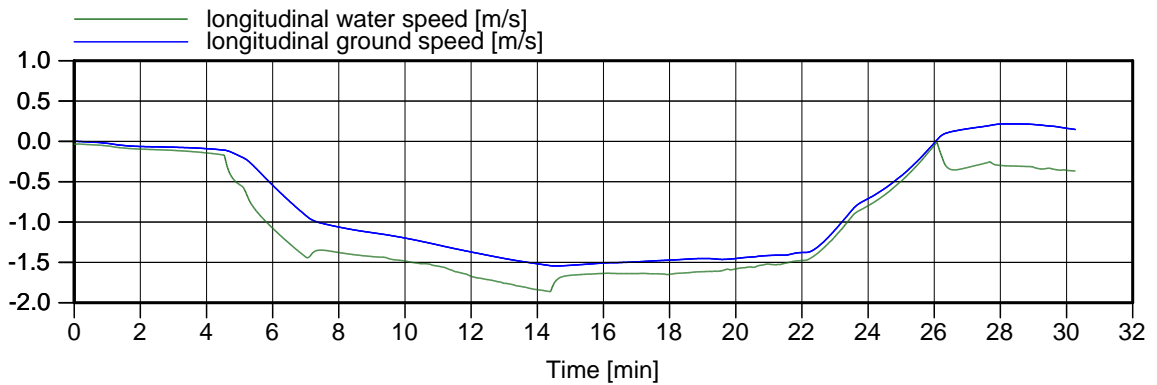
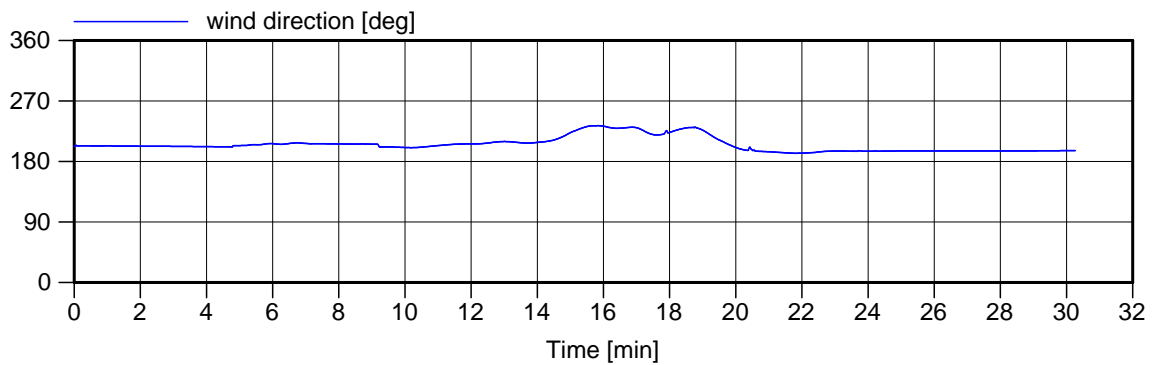
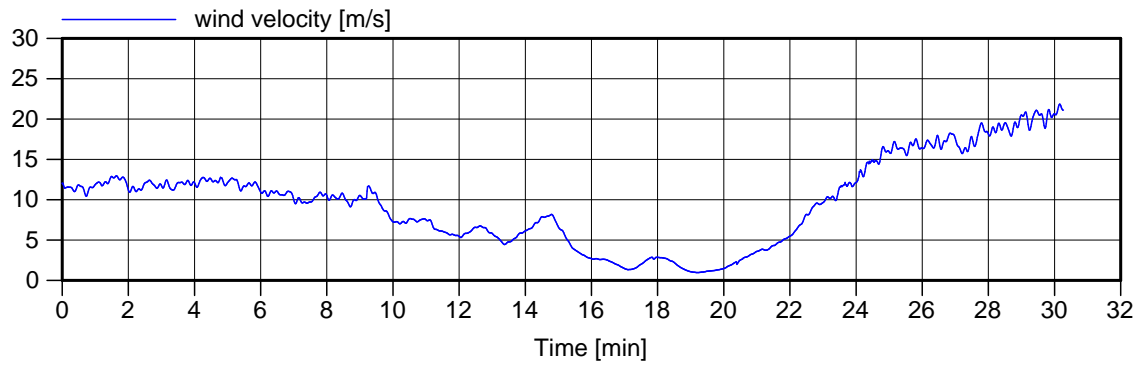

Environment

Run: 17-18 Dep

Ship: Valemax 362x65x14.0

Wind: SSW 15.5 m/s

Current: Slack HW

Figure: 18.b

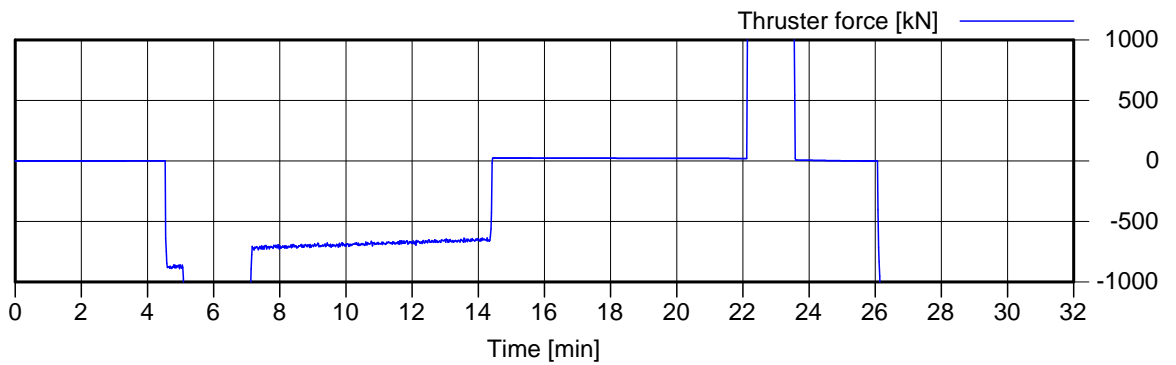
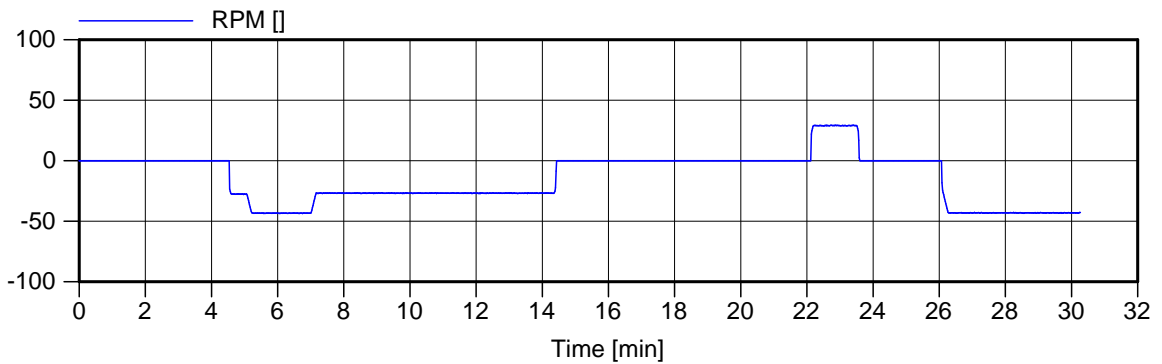
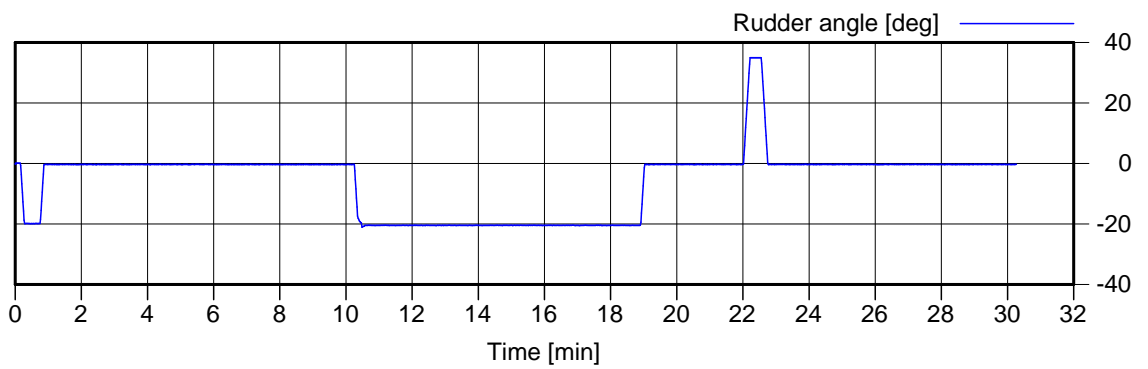
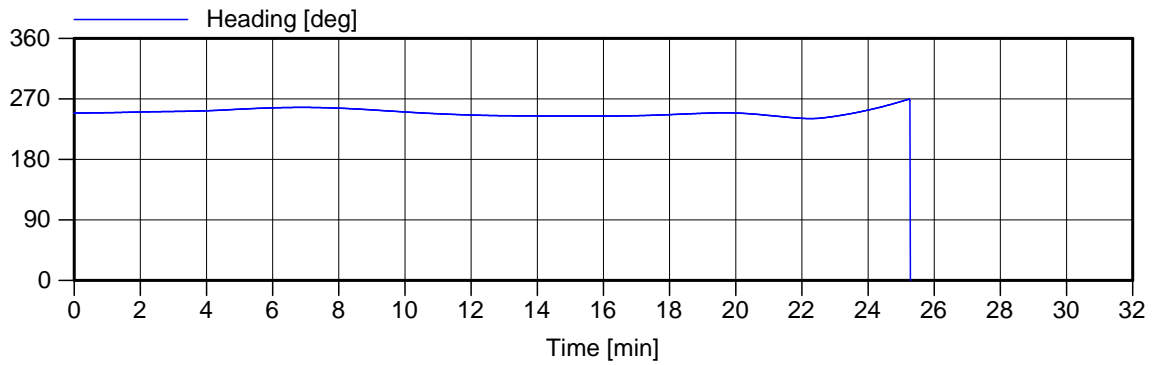

Ship data 1

Ship: Valemax 362x65x14.0

Current: Slack HW

Run: 17-18 Dep

Wind: SSW 15.5 m/s

Figure: 18.c

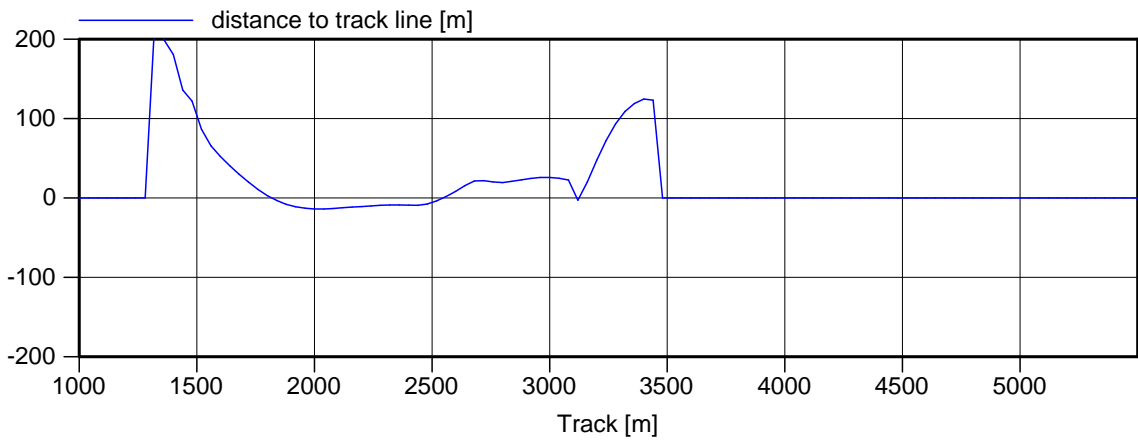
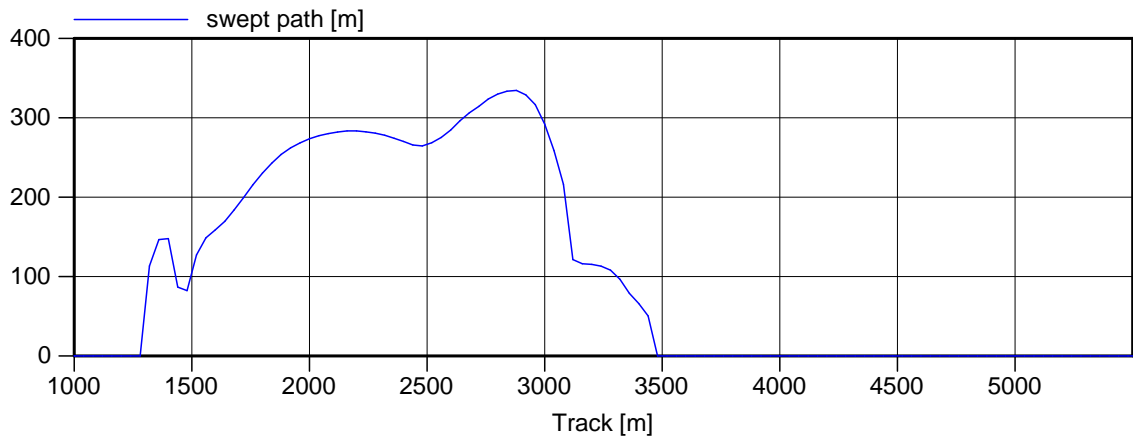

Space used	Run: 17-18 Dep
Ship: Valemax 362x65x14.0	Wind: SSW 15.5 m/s
Current: Slack HW	Figure: 18.e

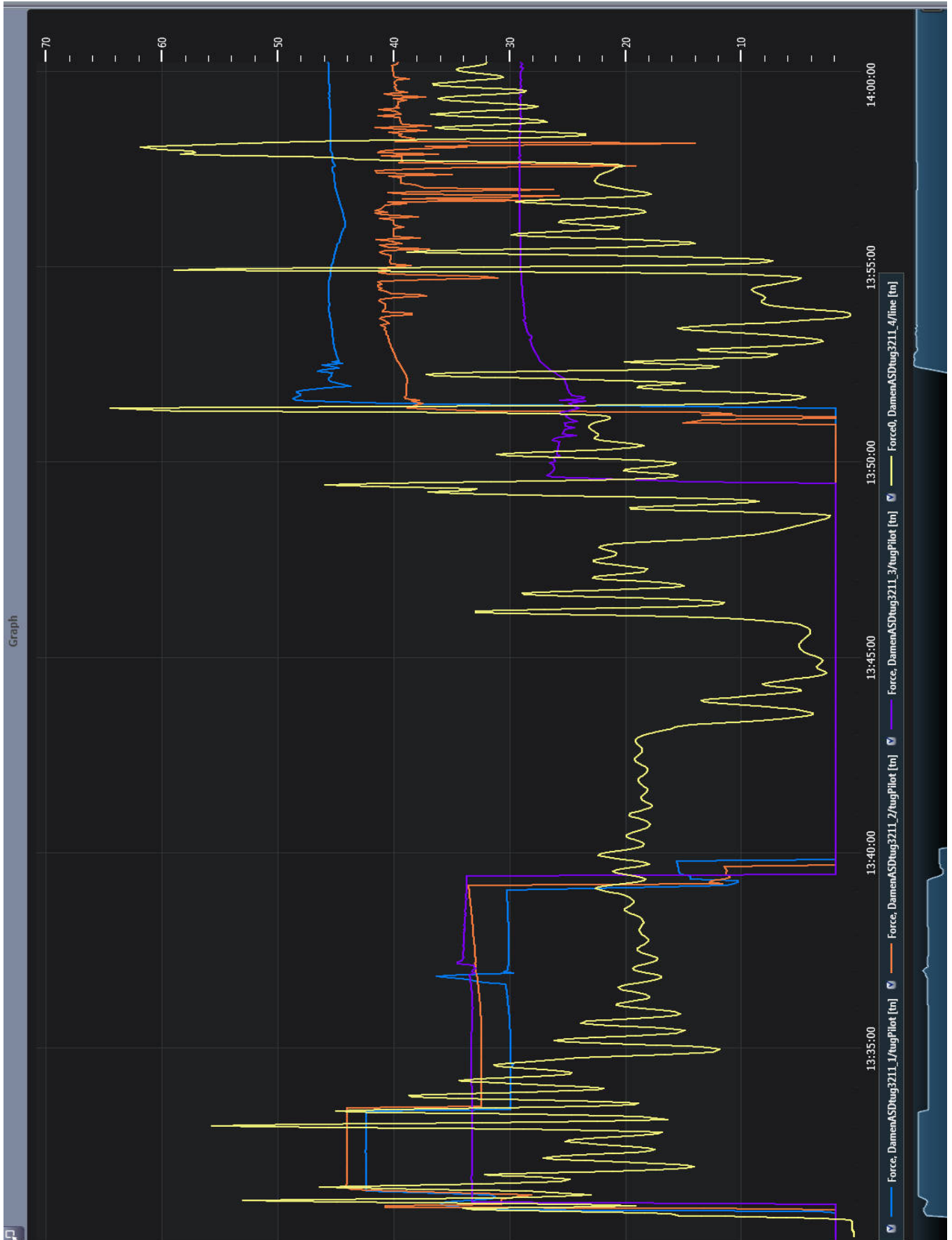

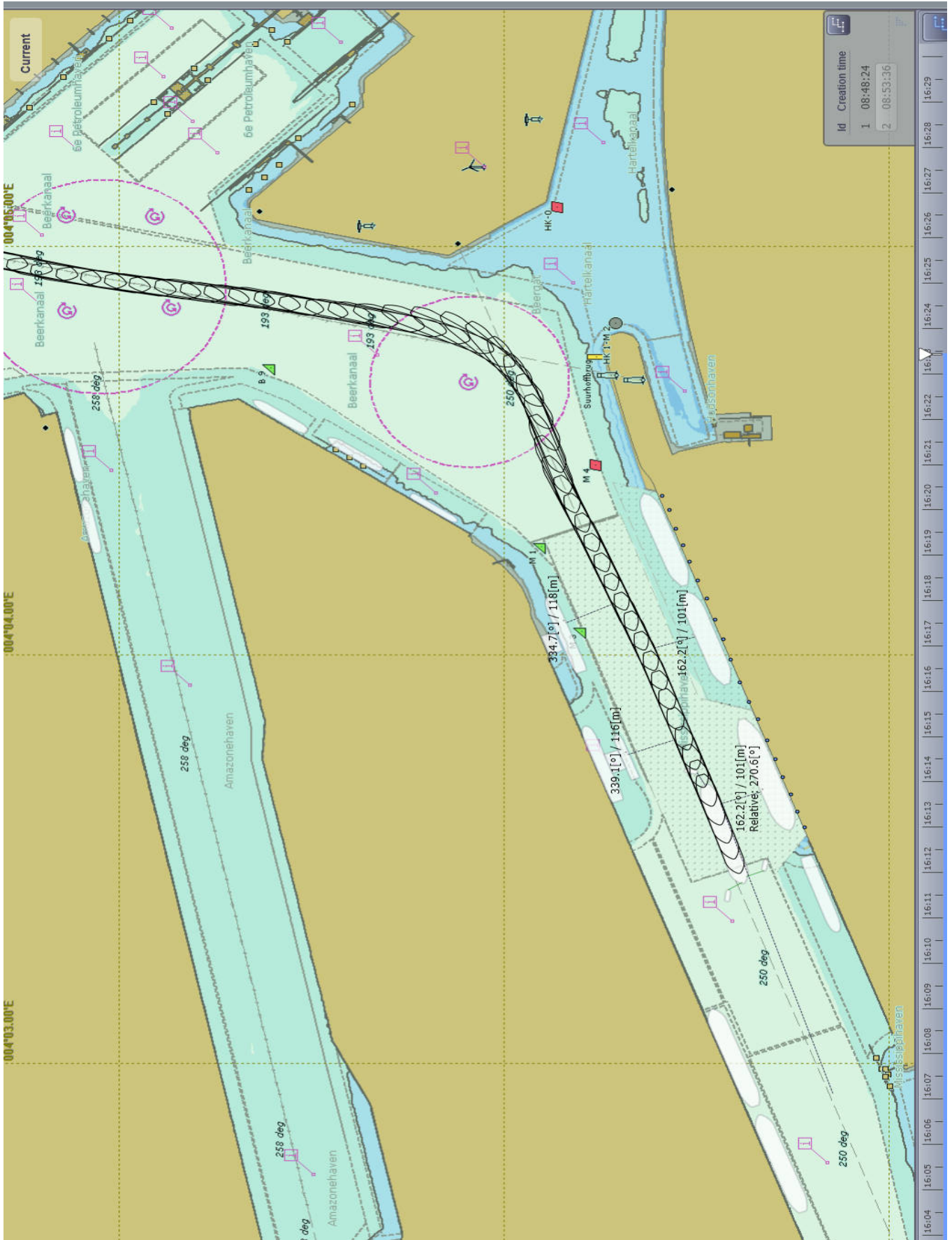

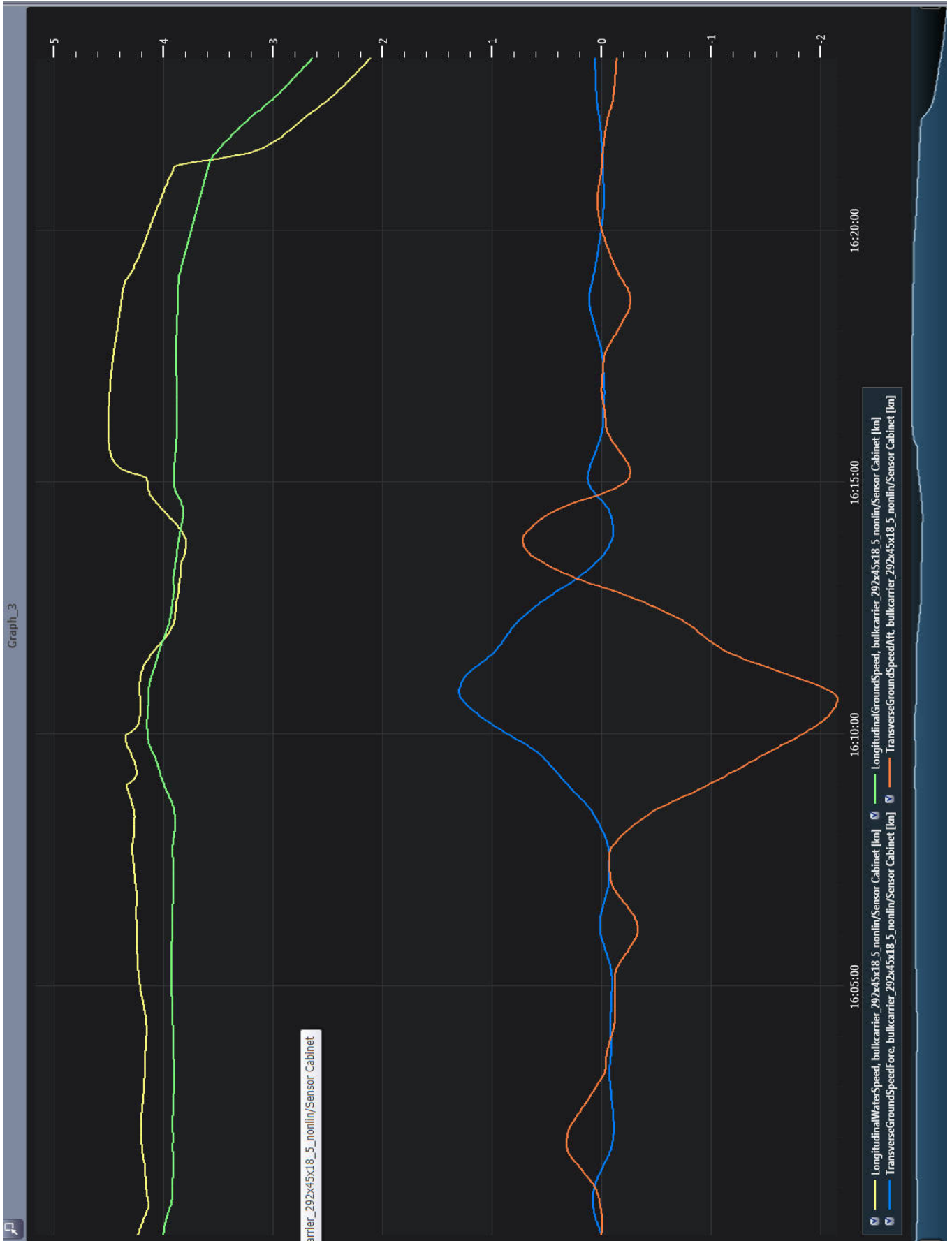

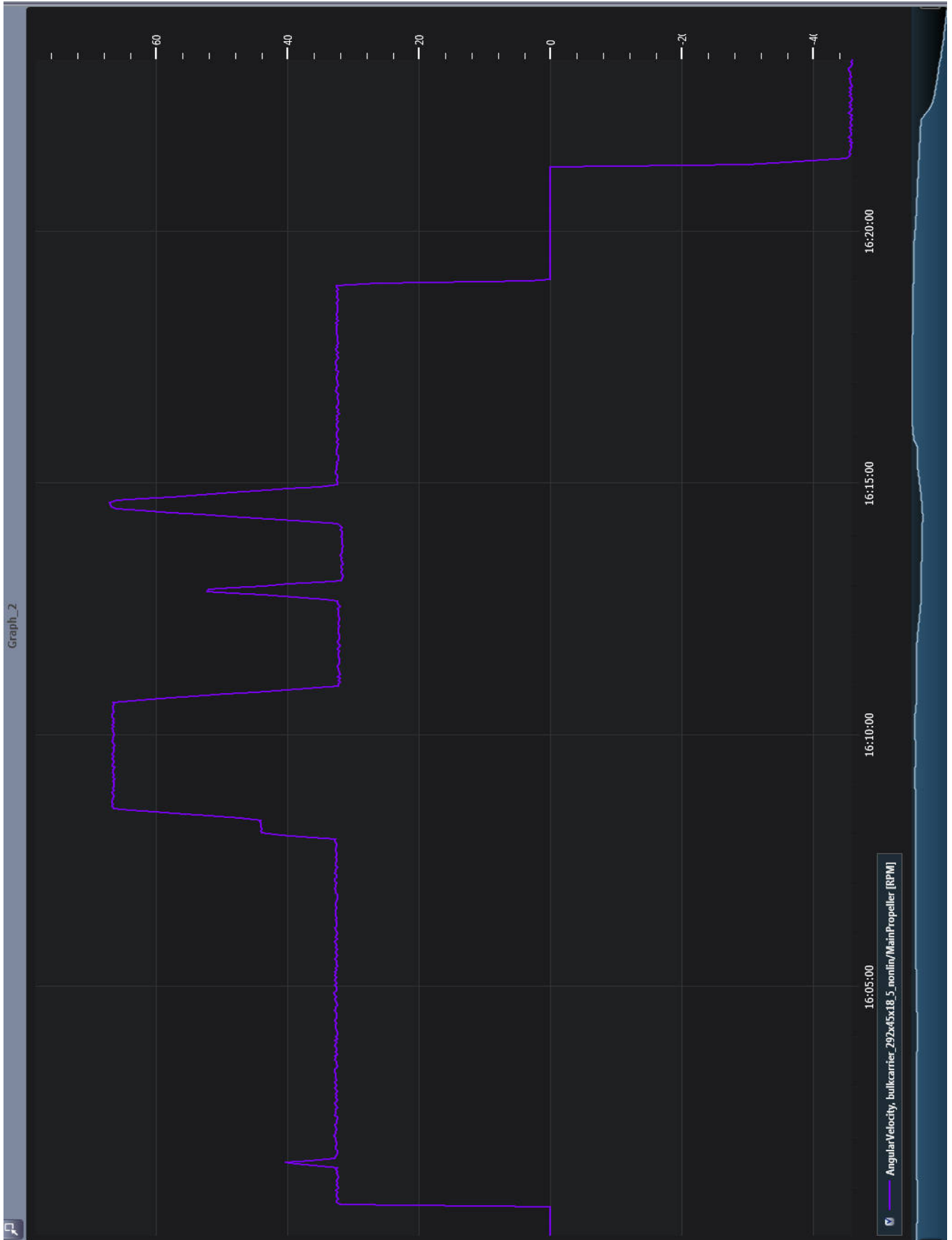

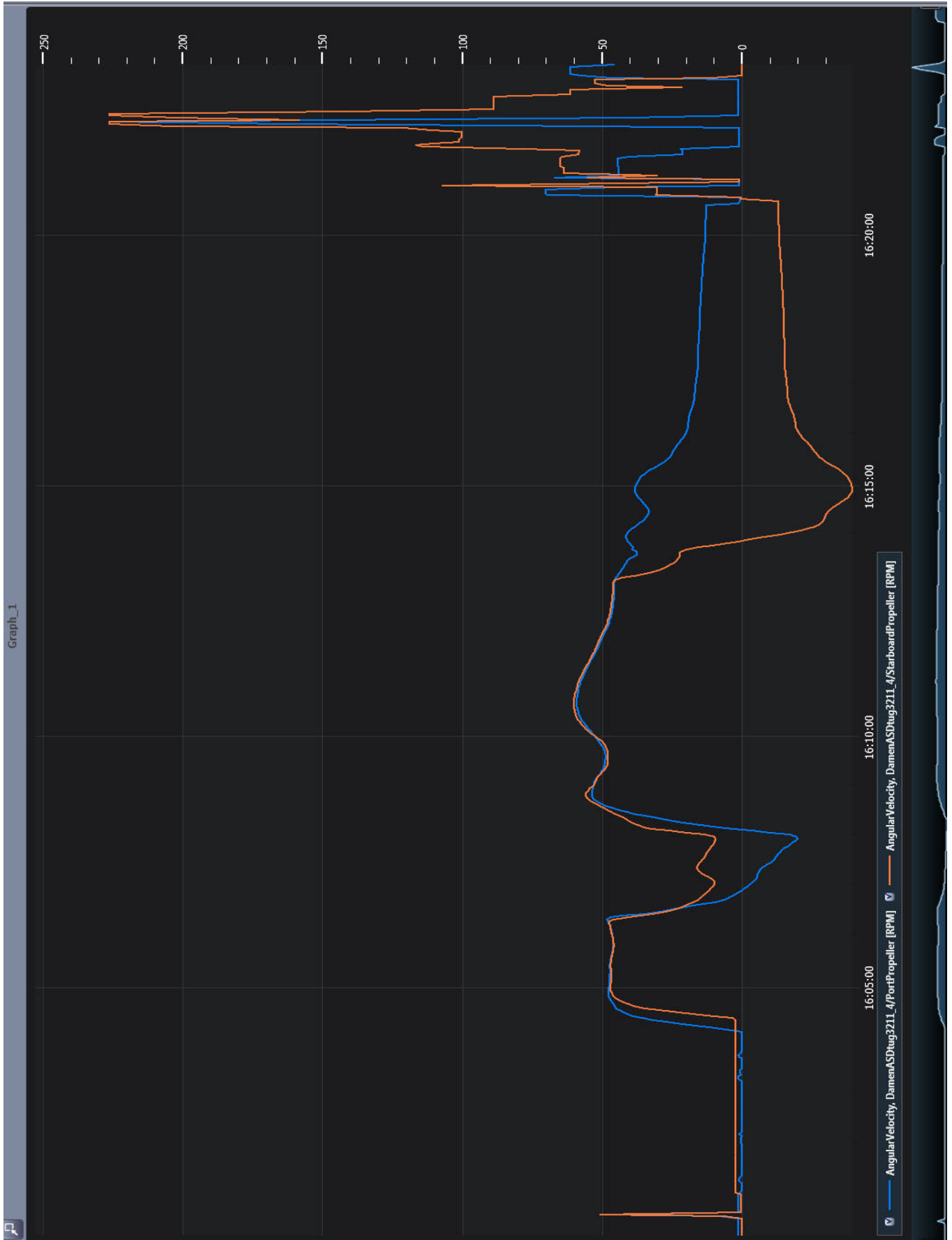

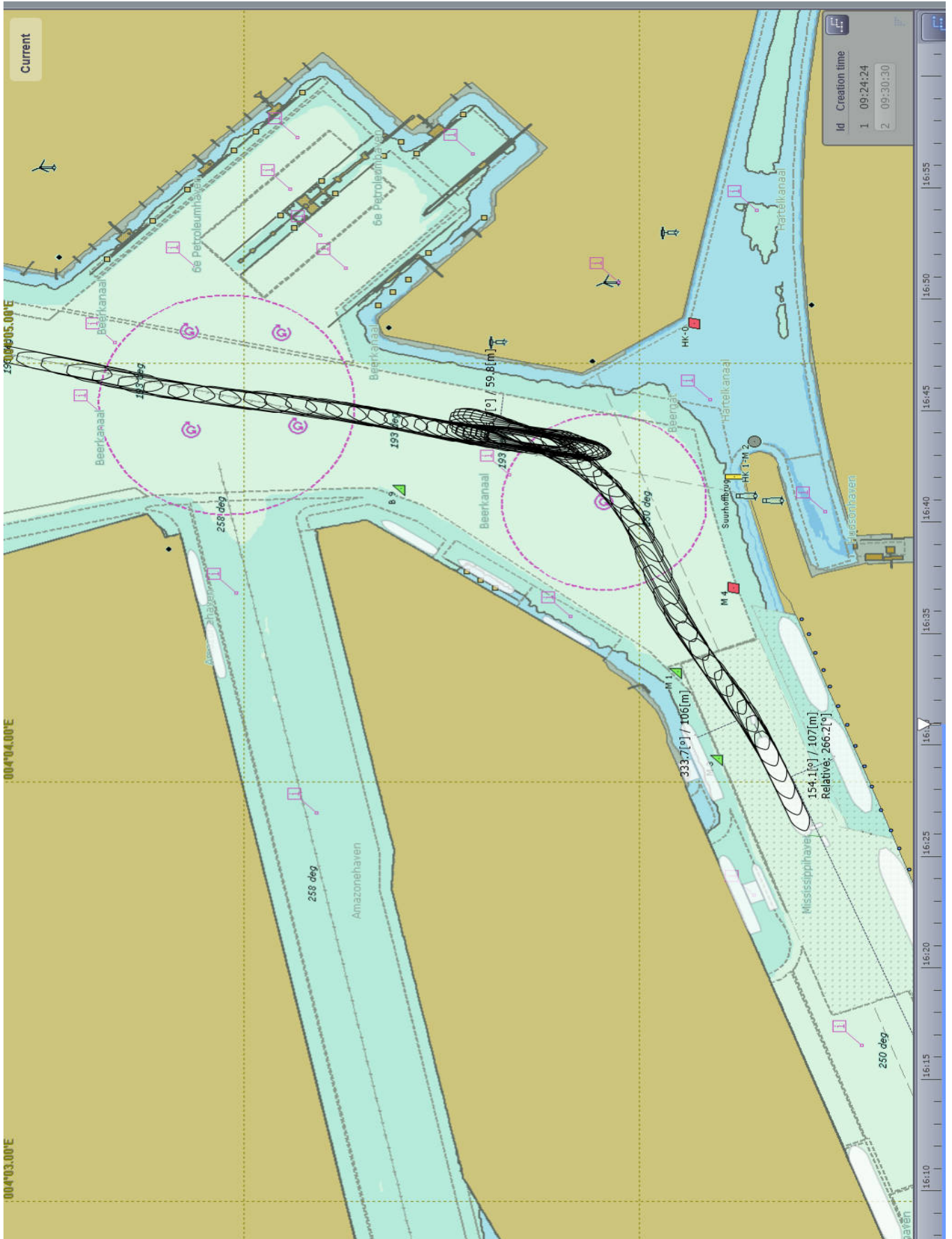

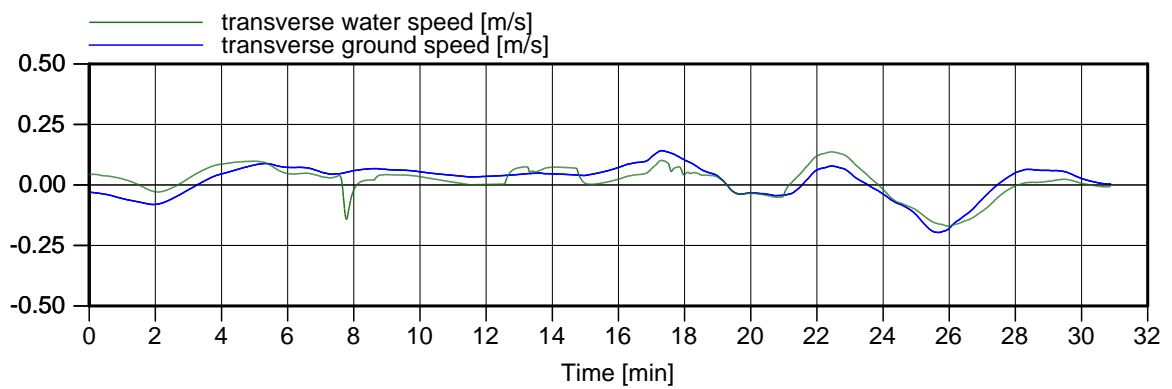
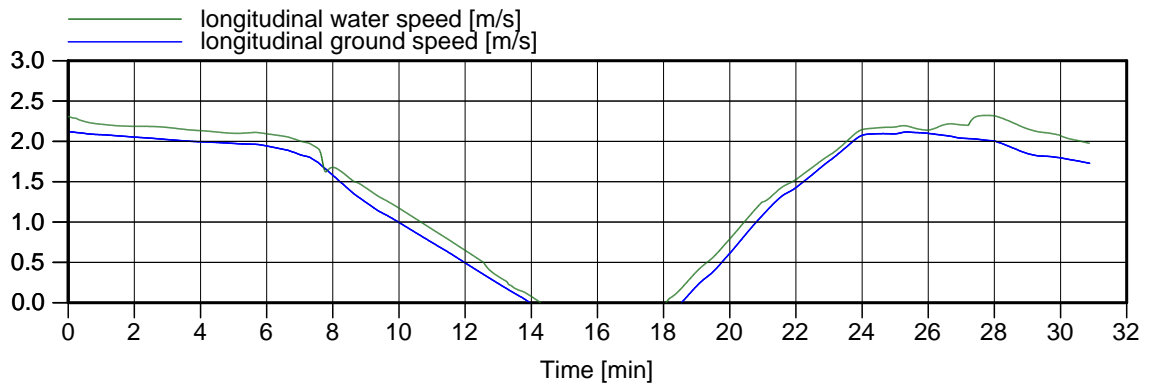
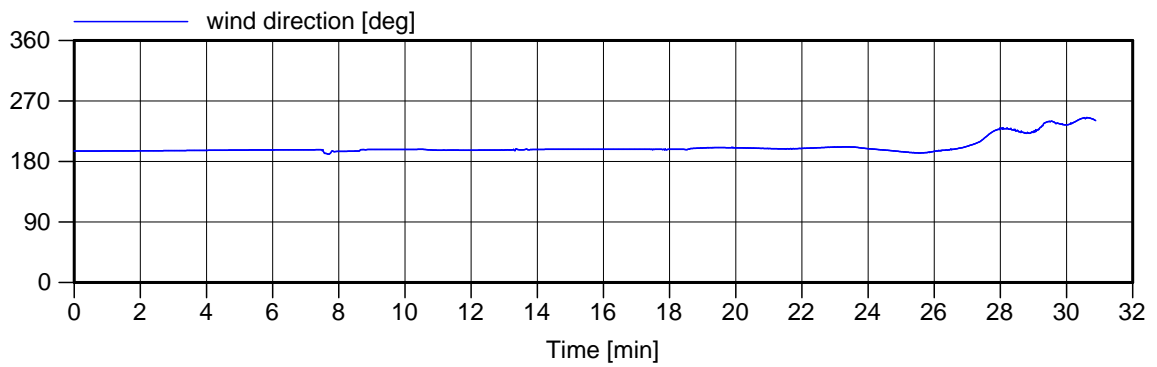
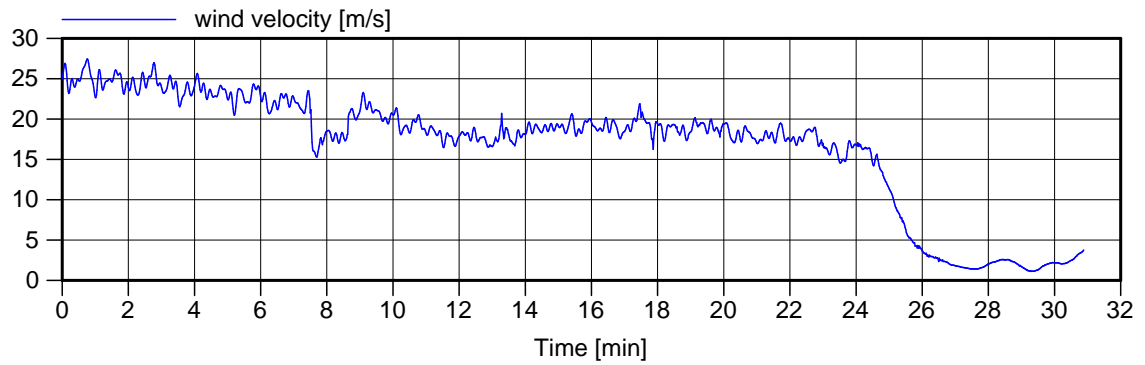

Environment

Run: 18-20 Arr

Ship: Capesize 292x45x18.5

Wind: SSW 15.5 m/s

Current: Ebb max

Figure: 20.b

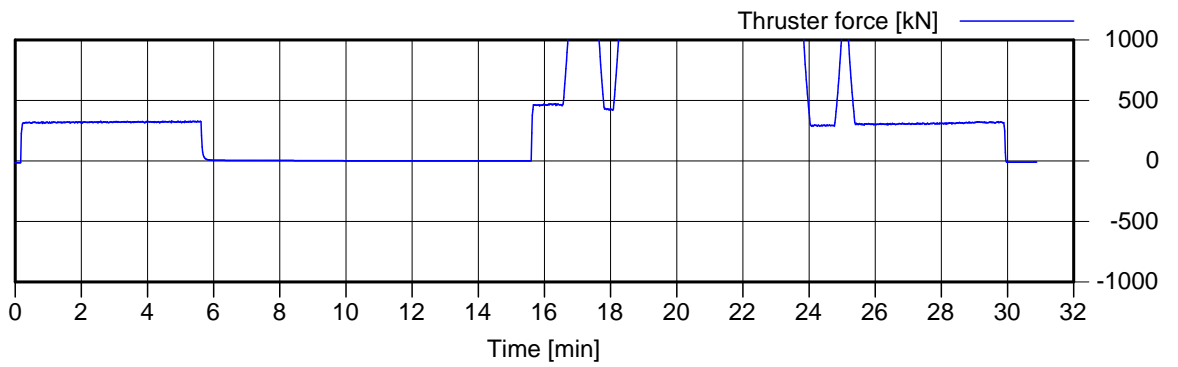
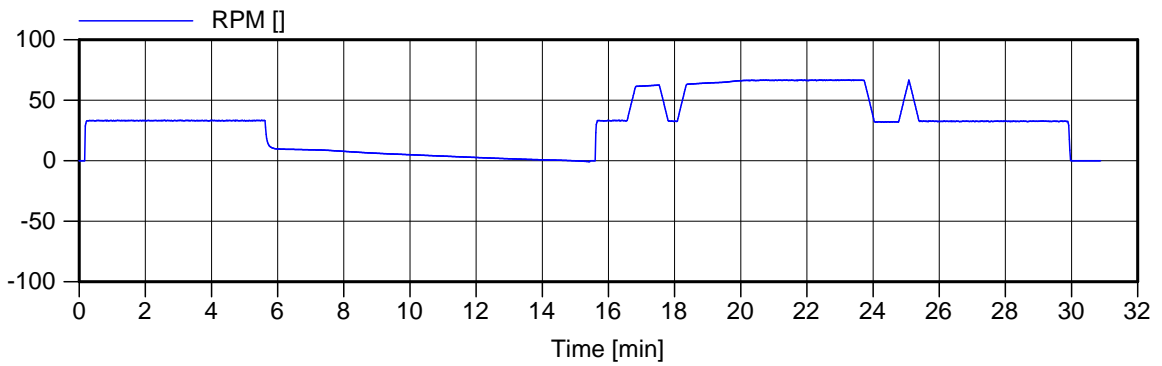
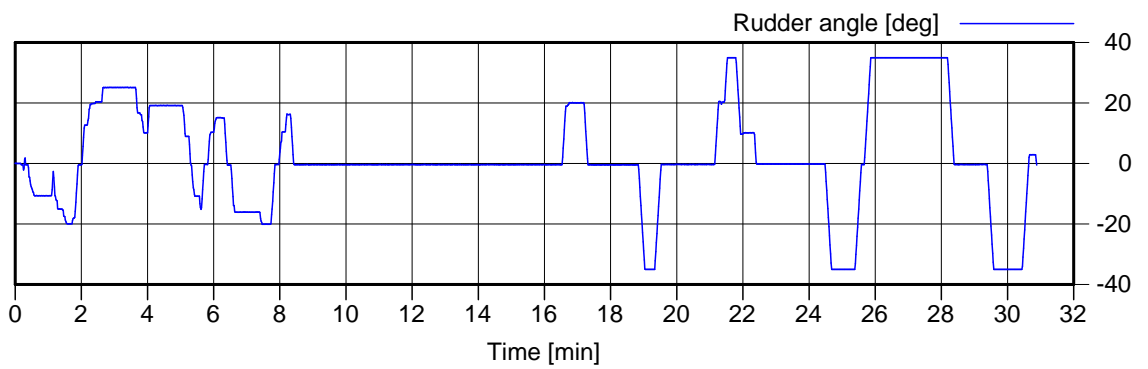
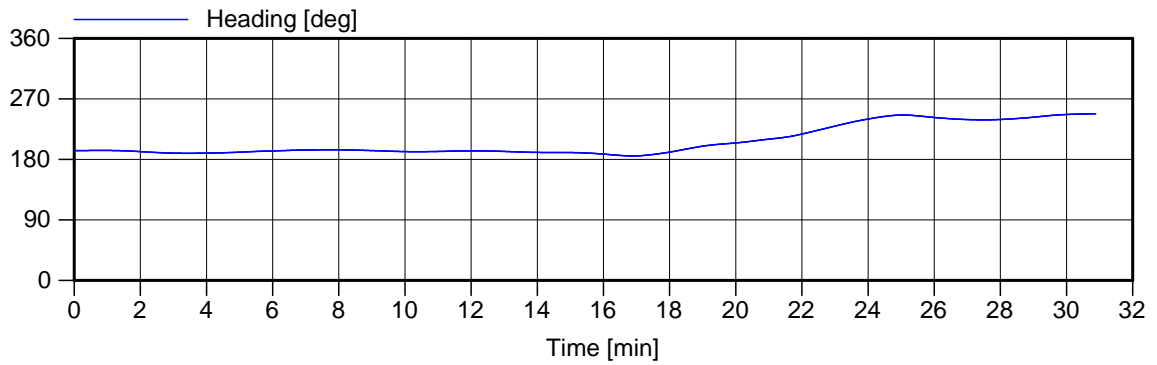

Ship data 1	Run: 18-20 Arr
Ship: Capesize 292x45x18.5	Wind: SSW 15.5 m/s
Current: Ebb max	Figure: 20.c

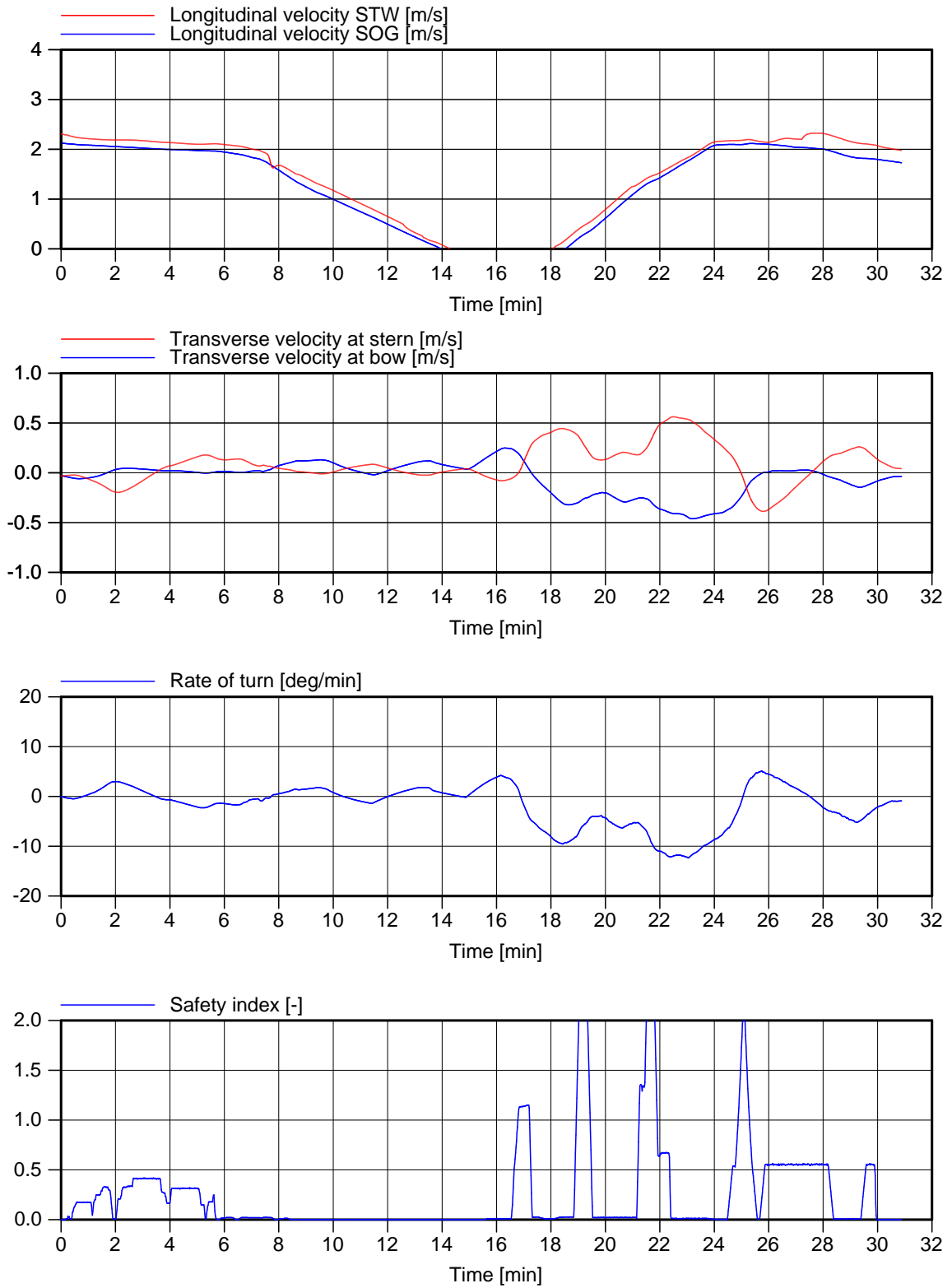

Ship data 2

Ship: Capesize 292x45x18.5

Current: Ebb max

Run: 18-20 Arr

Wind: SSW 15.5 m/s

Figure: 20.d

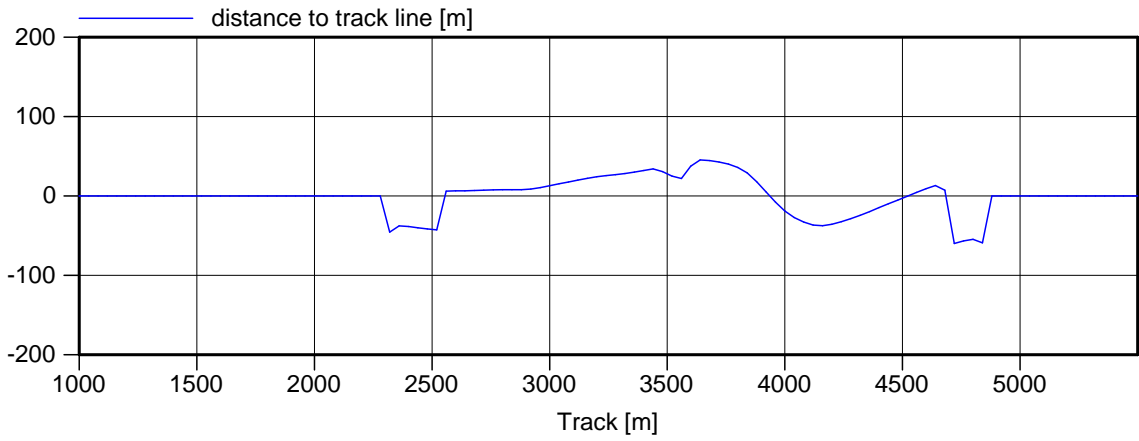
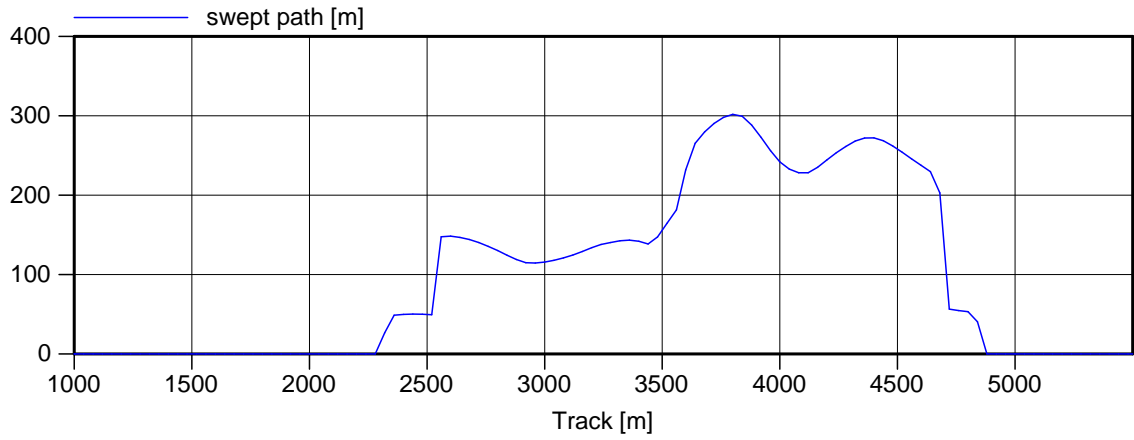

Space used	Run: 18-20 Arr
Ship: Capesize 292x45x18.5	Wind: SSW 15.5 m/s
Current: Ebb max	Figure: 20.e

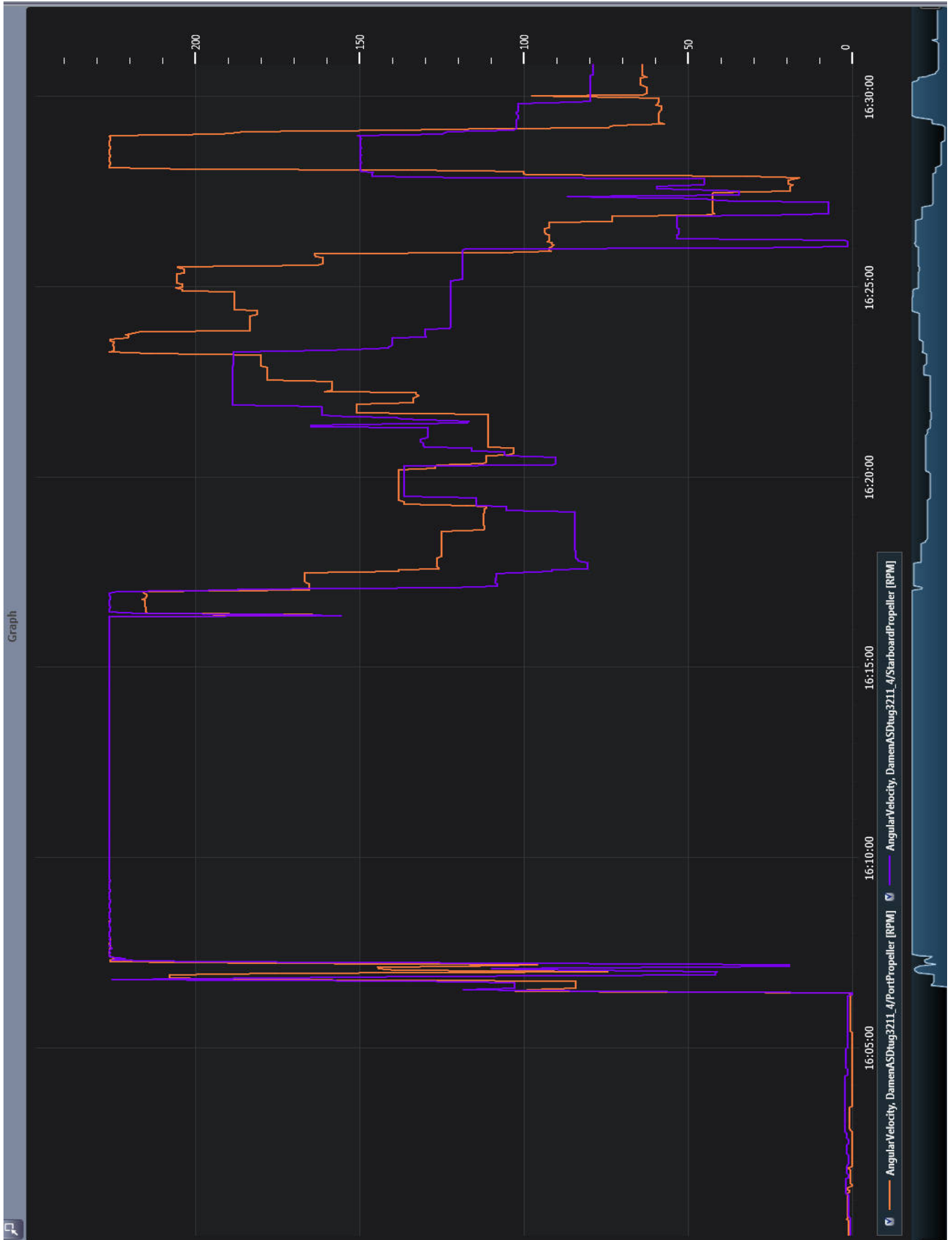

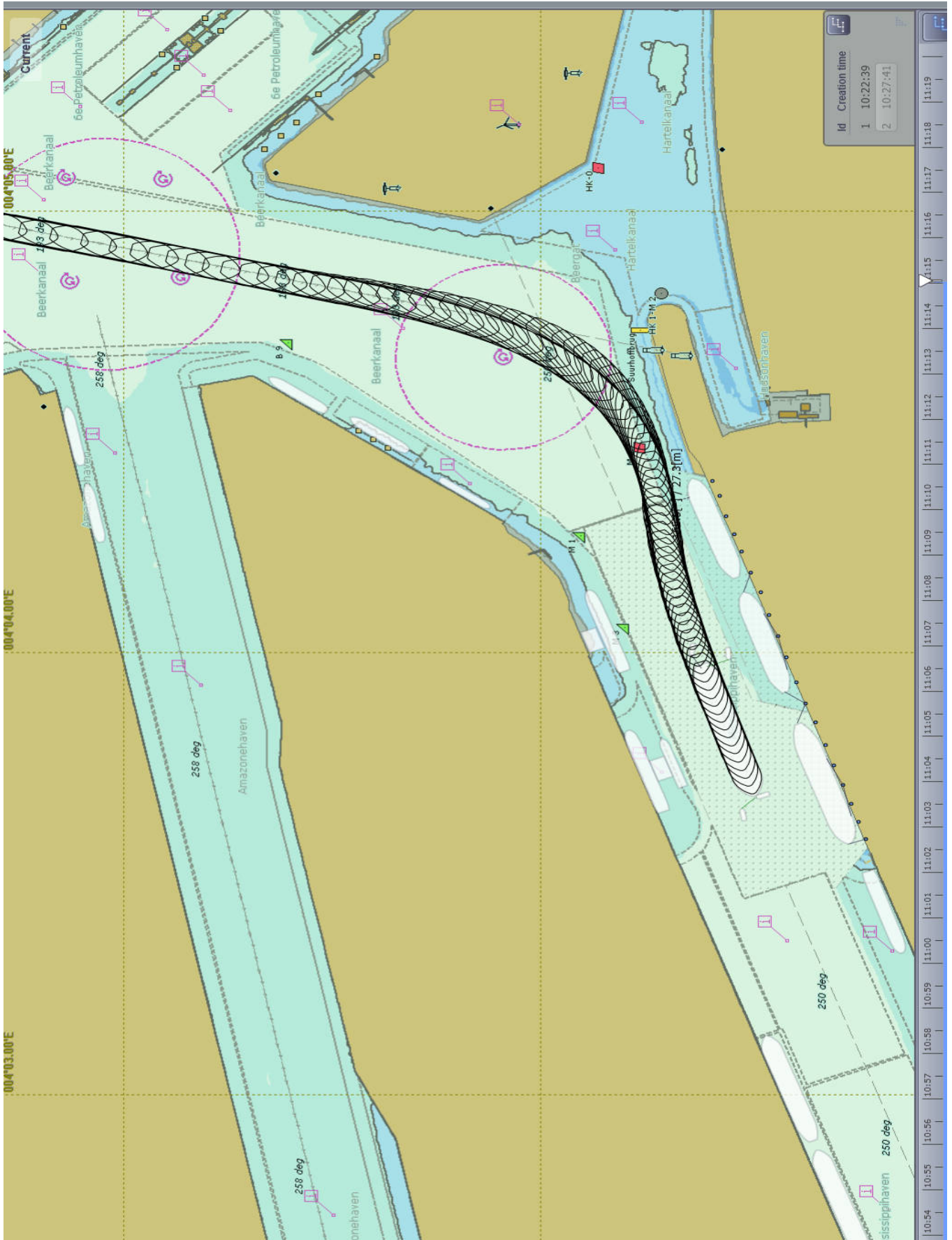

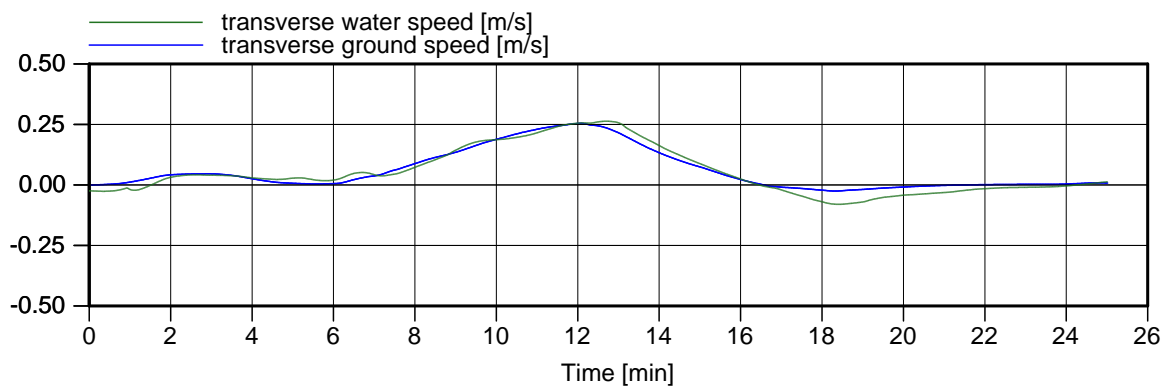
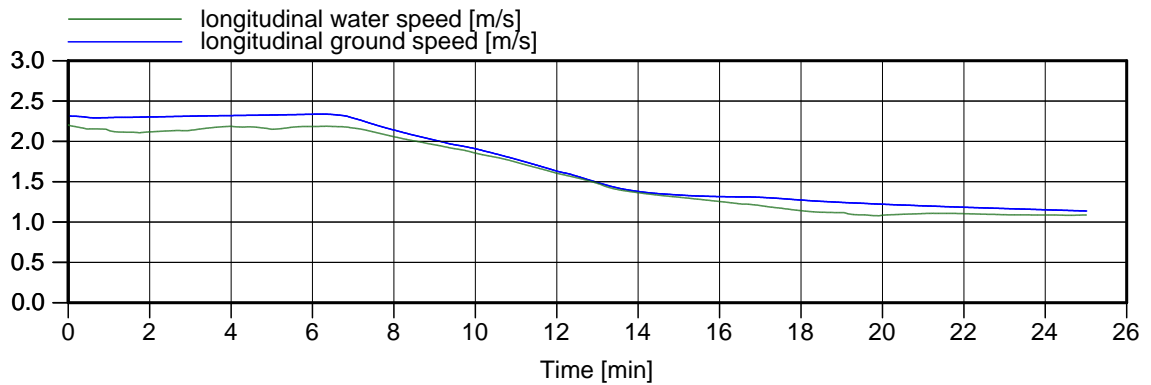
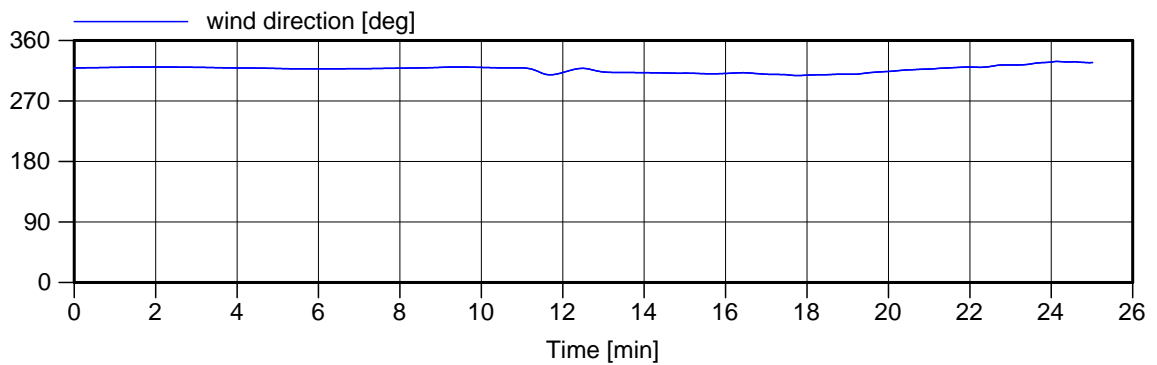
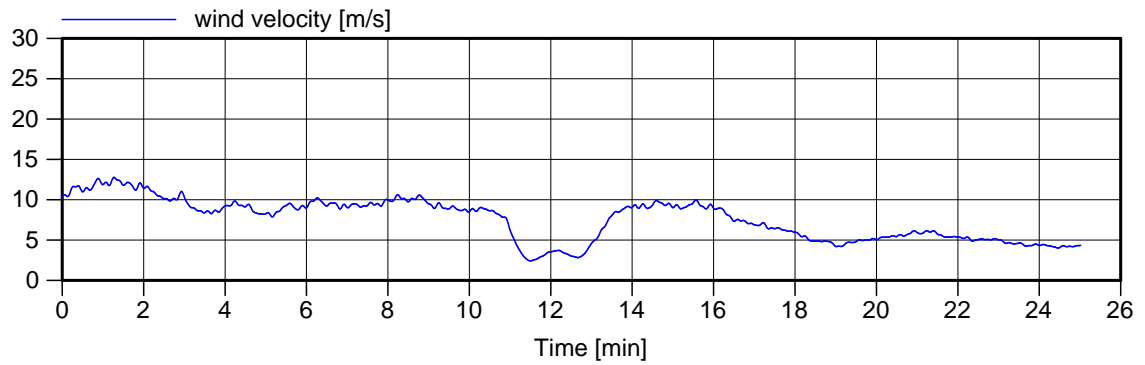

Environment

Run: 18-21 Arr

Ship: Valemax 362x65x22.6

Wind: NW 15.5 m/s

Current: Flood max

Figure: 21.b

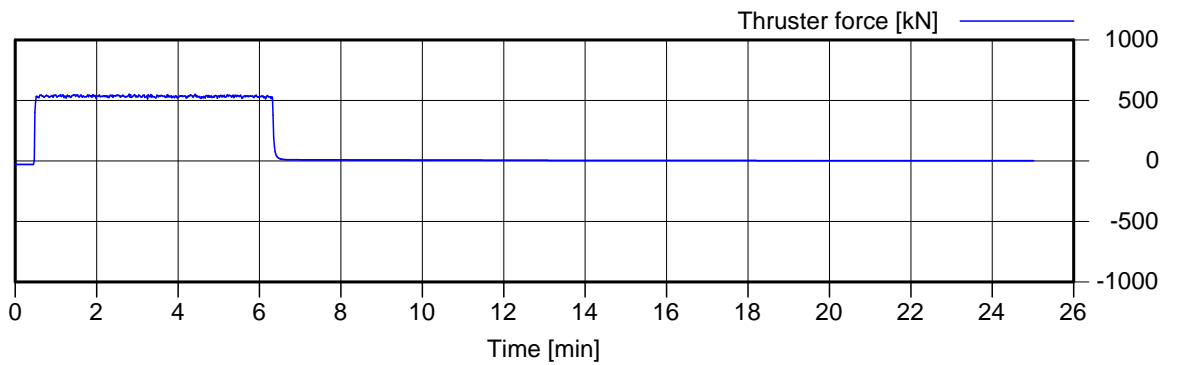
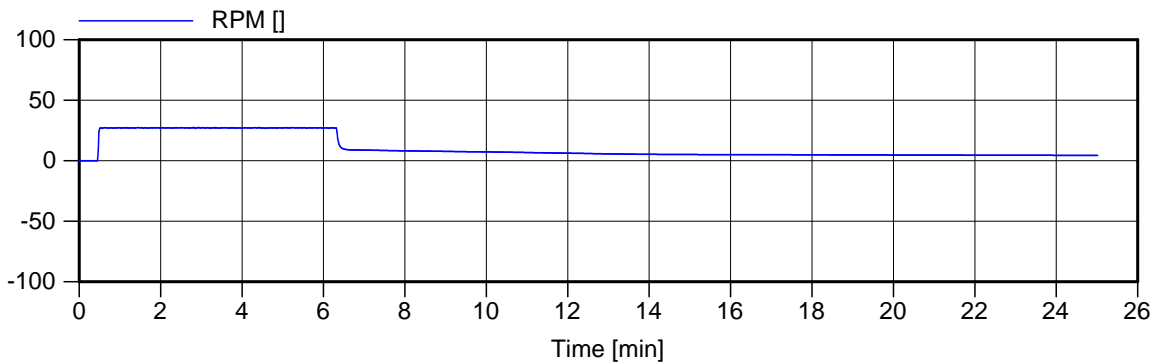
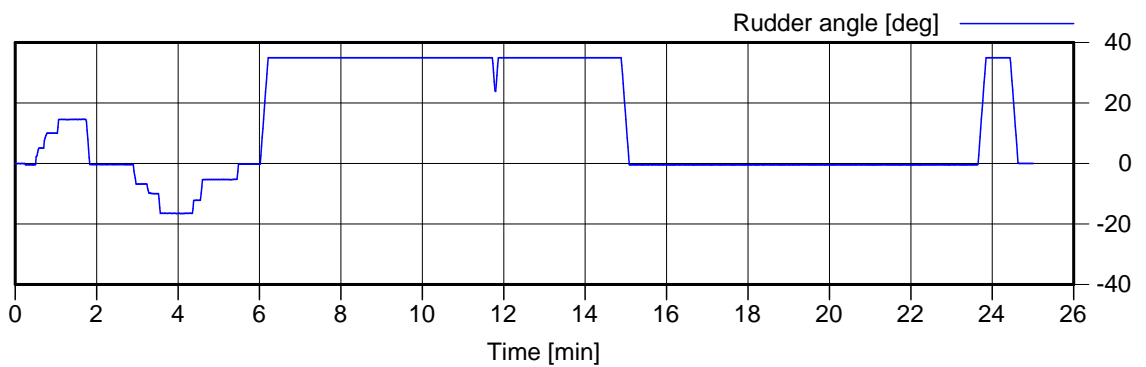
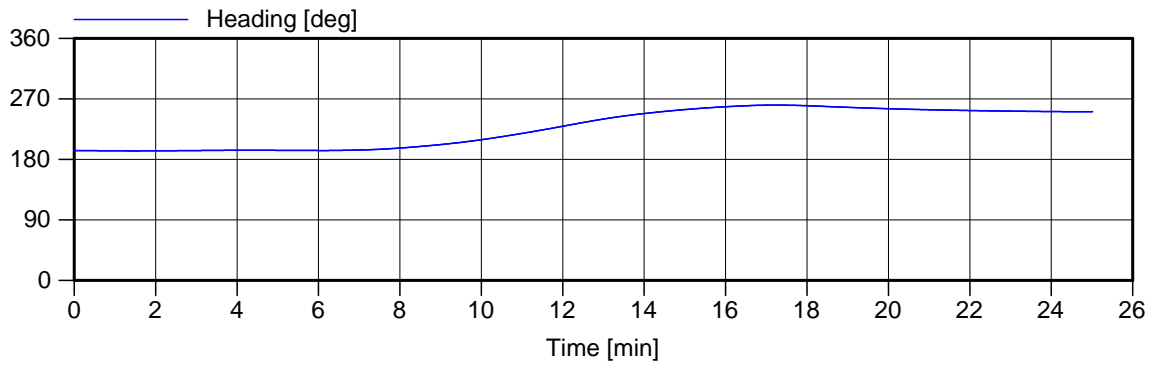

Ship data 1

Run: 18-21 Arr

Ship: Valemax 362x65x22.6

Wind: NW 15.5 m/s

Current: Flood max

Figure: 21.c

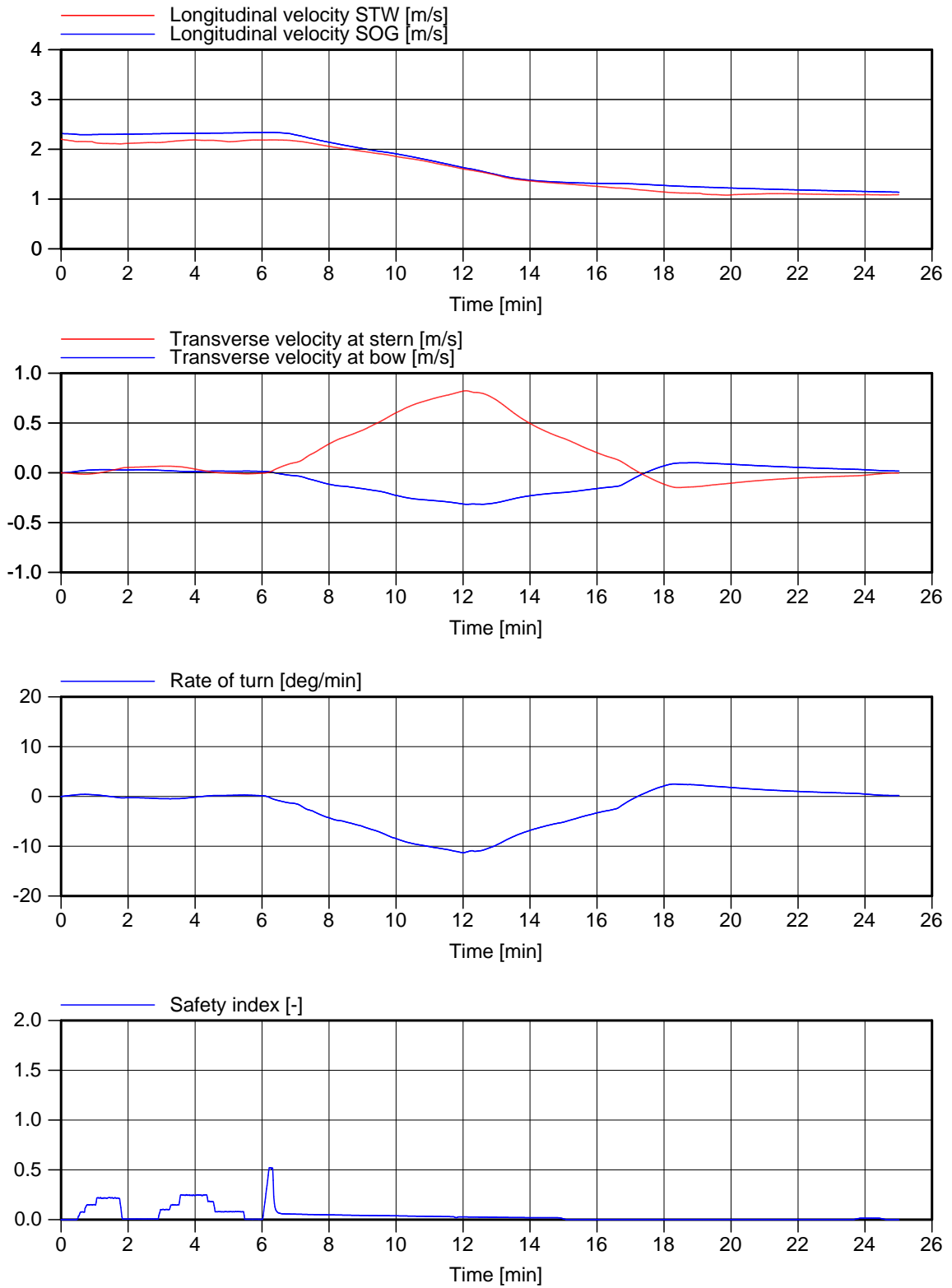

Ship data 2

Ship: Valemax 362x65x22.6

Current: Flood max

Run: 18-21 Arr

Wind: NW 15.5 m/s

Figure: 21.d

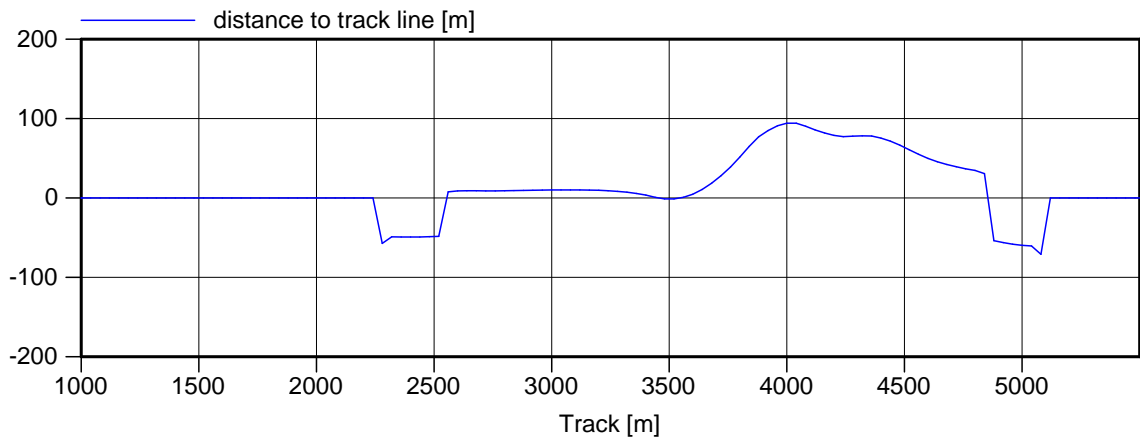
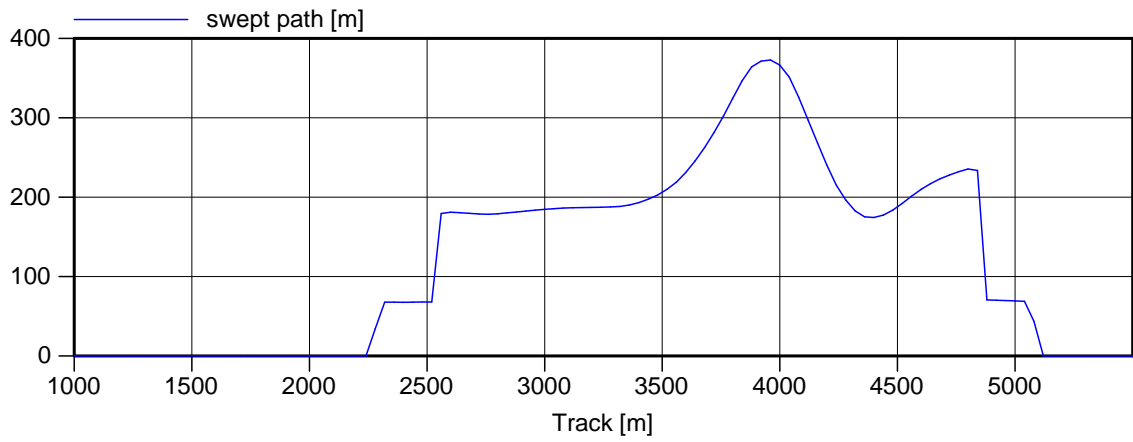

Space used

Run: 18-21 Arr

Ship: Valemax 362x65x22.6

Wind: NW 15.5 m/s

Current: Flood max

Figure: 21.e

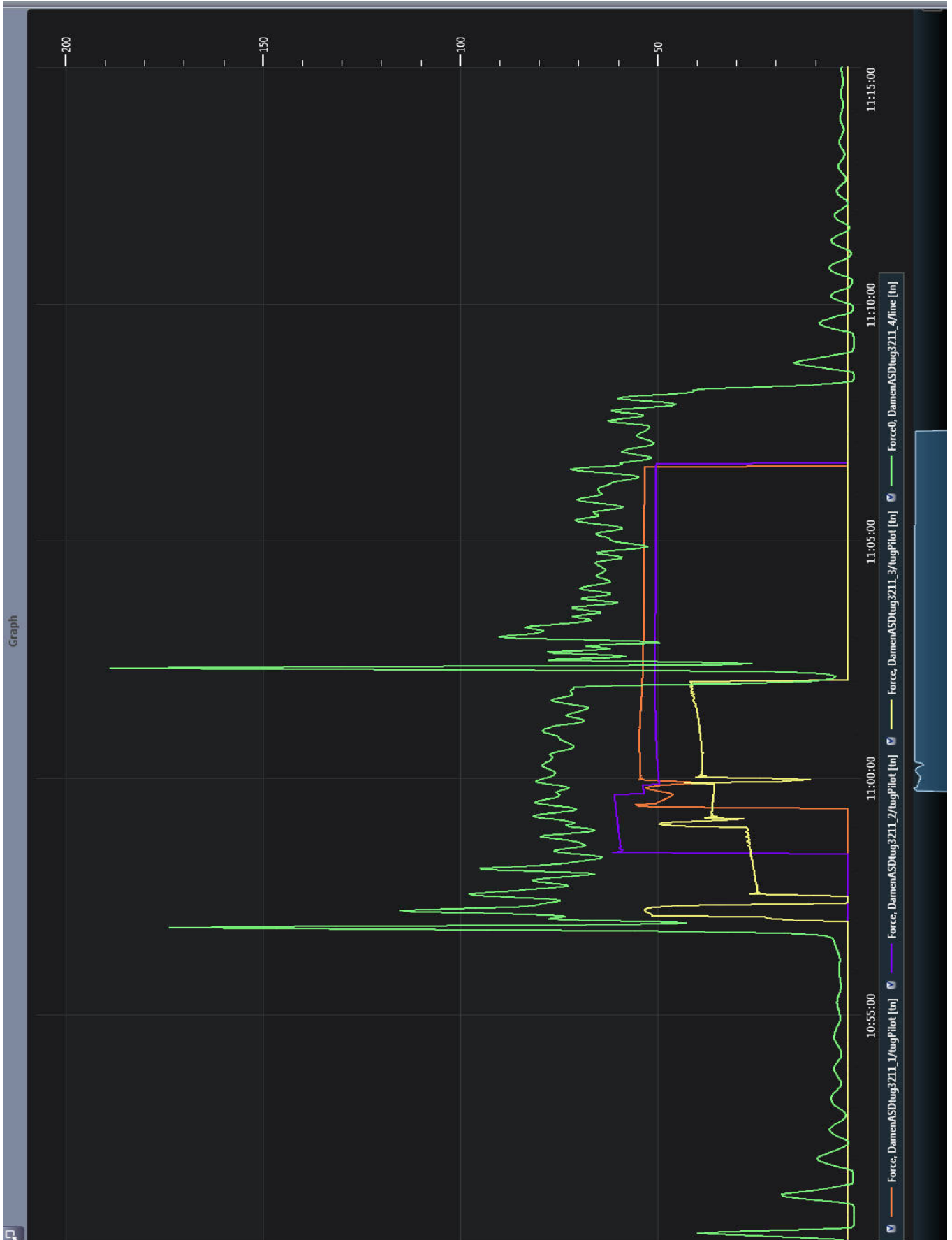

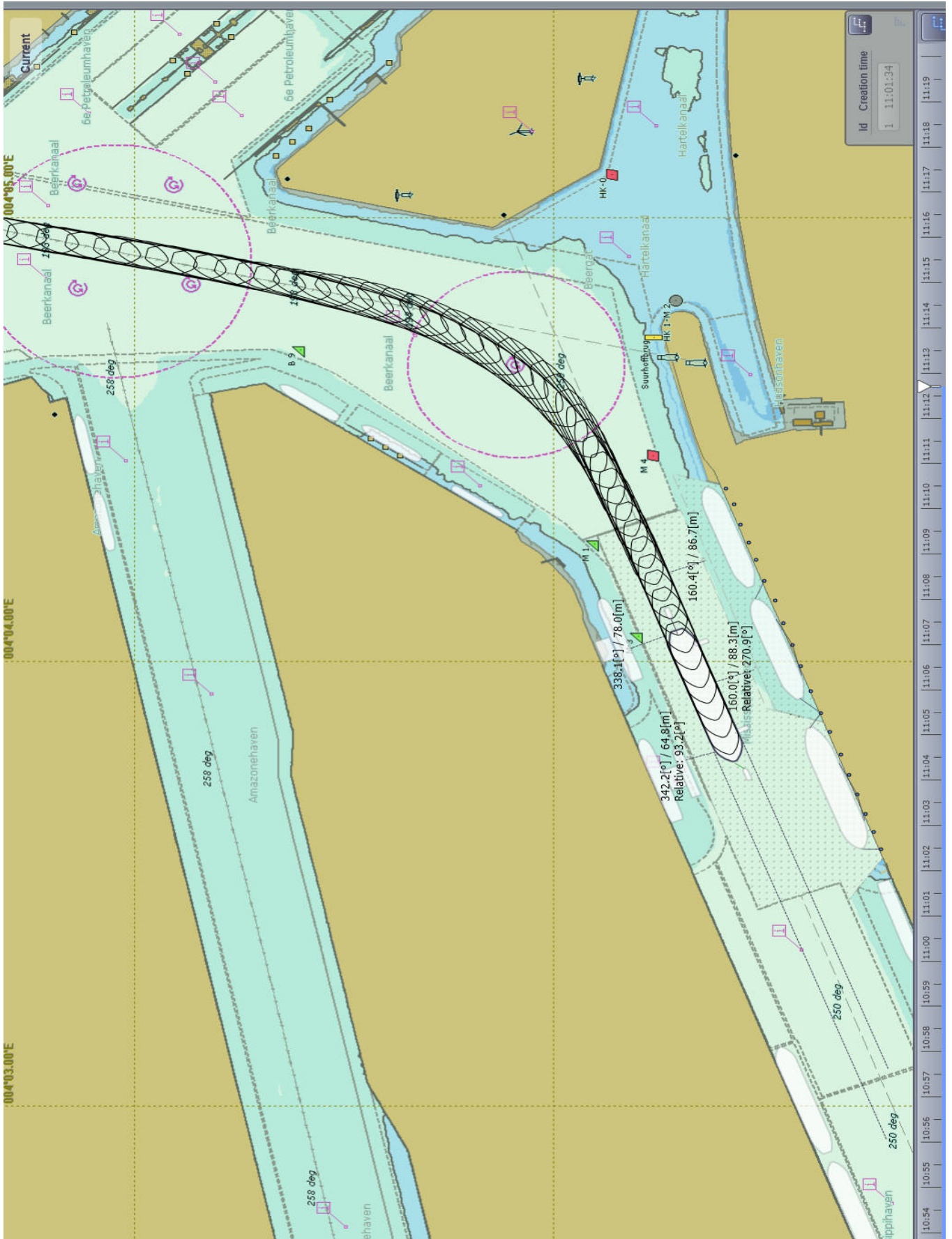

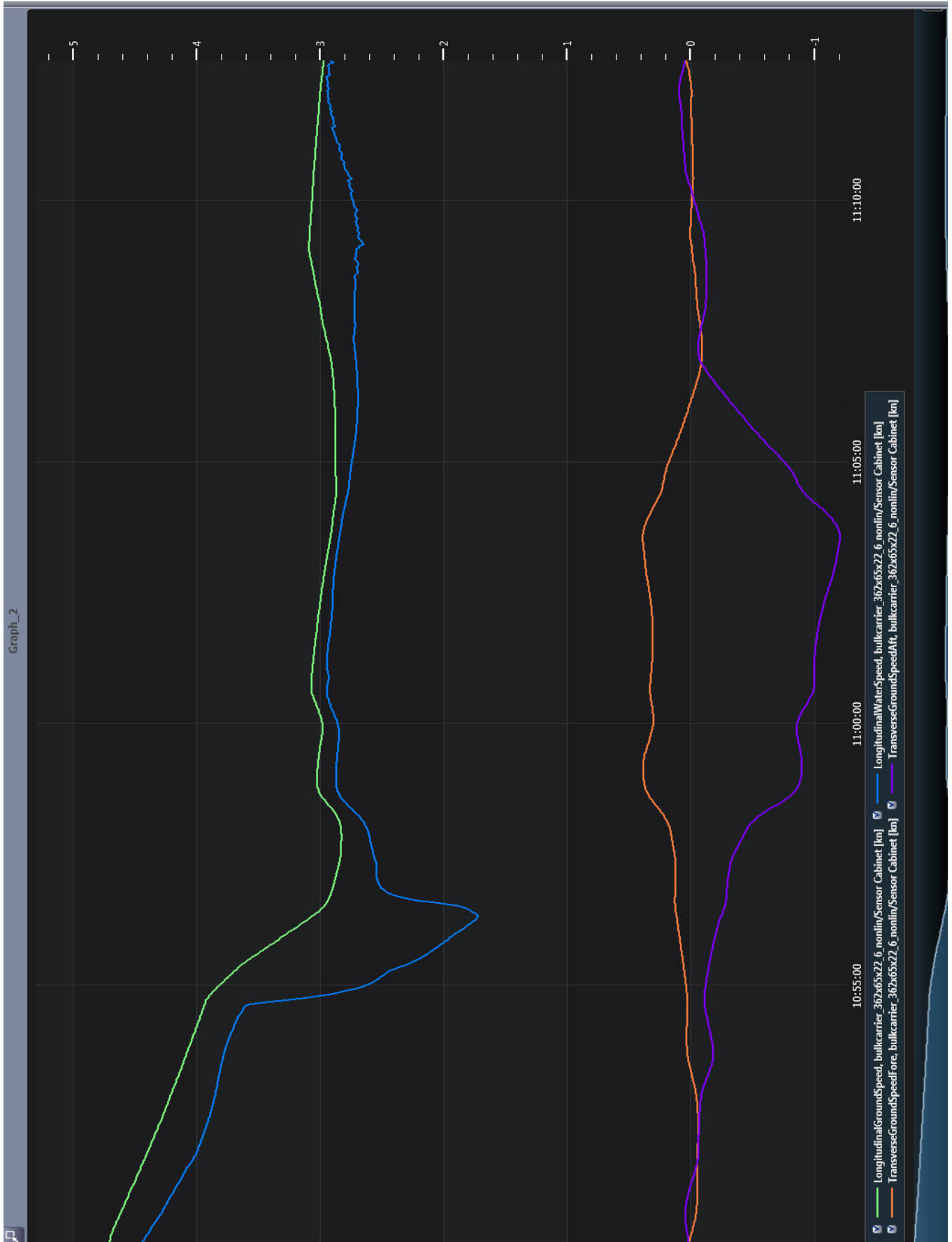



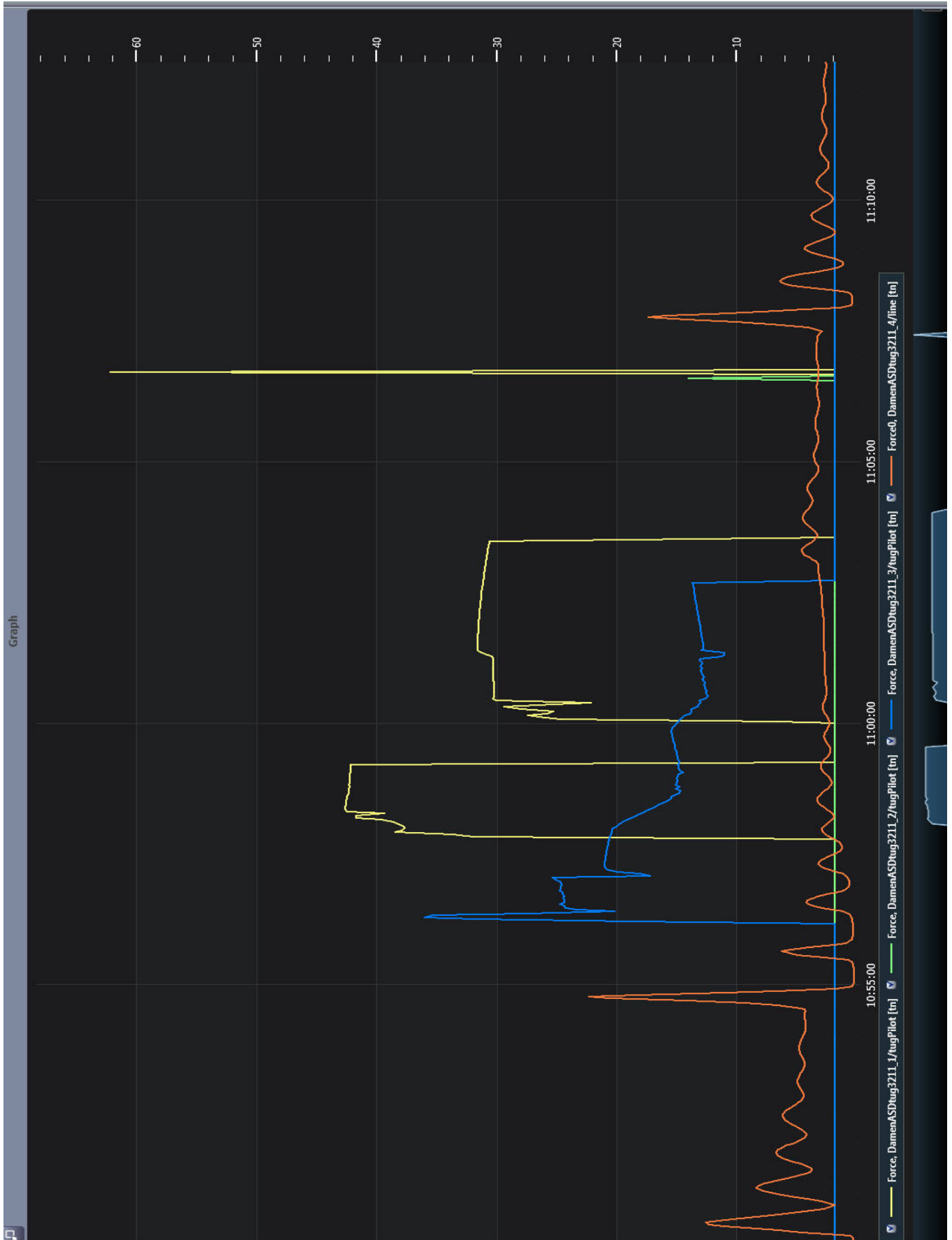

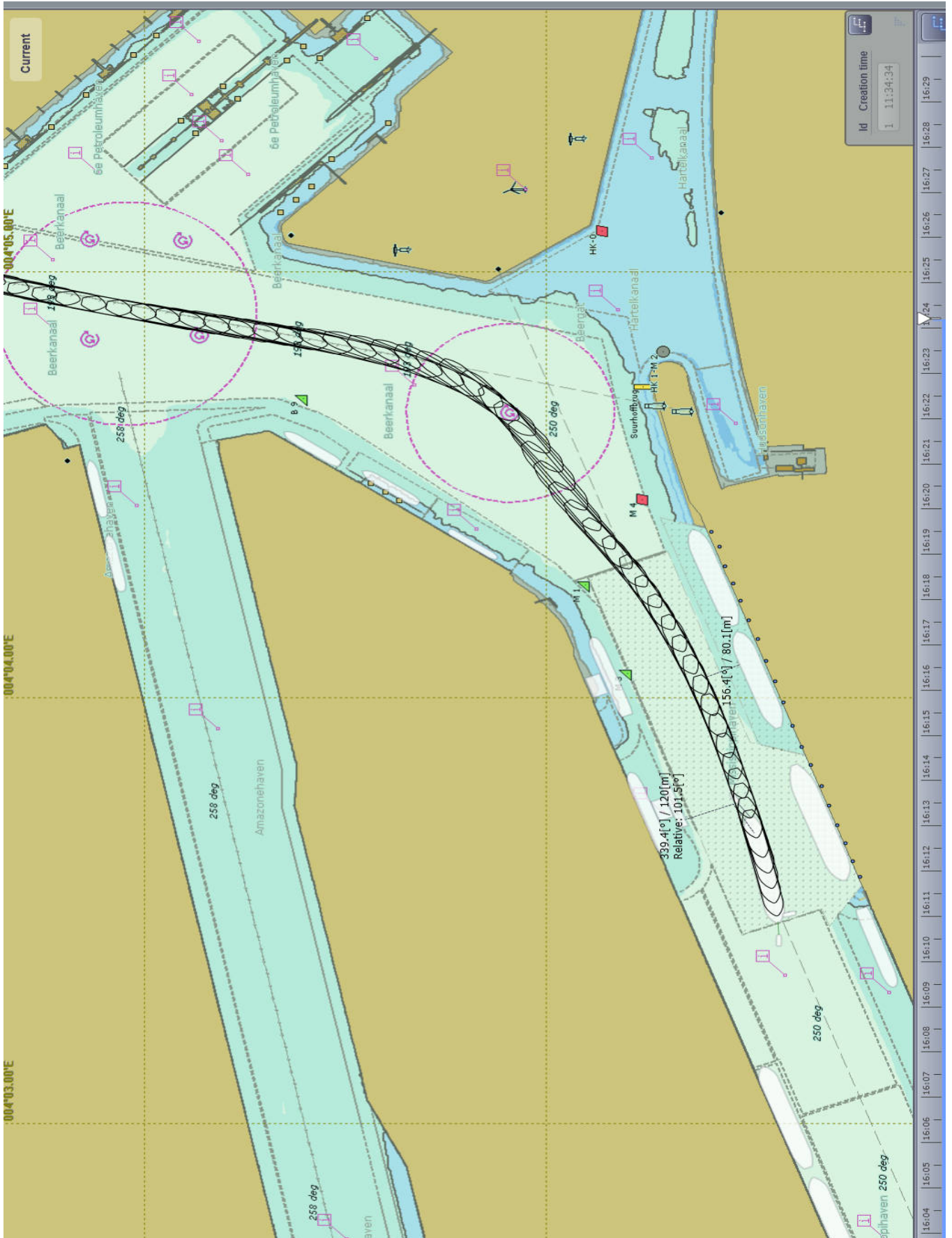

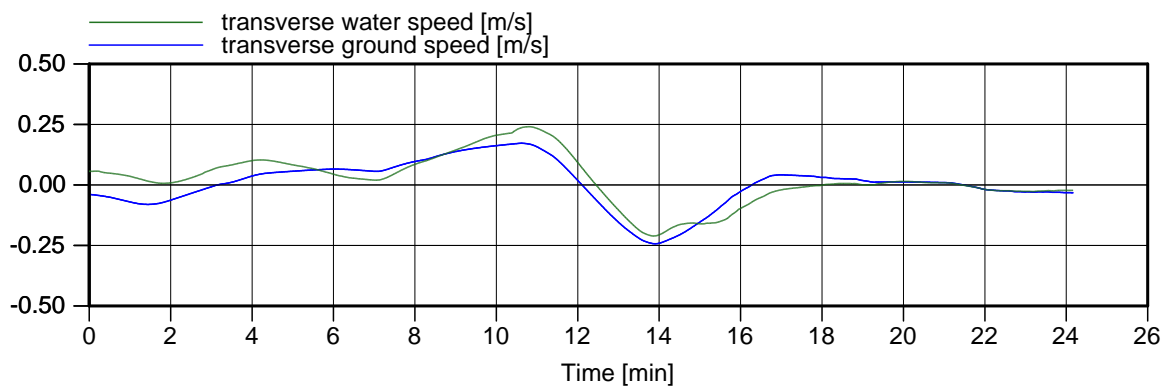
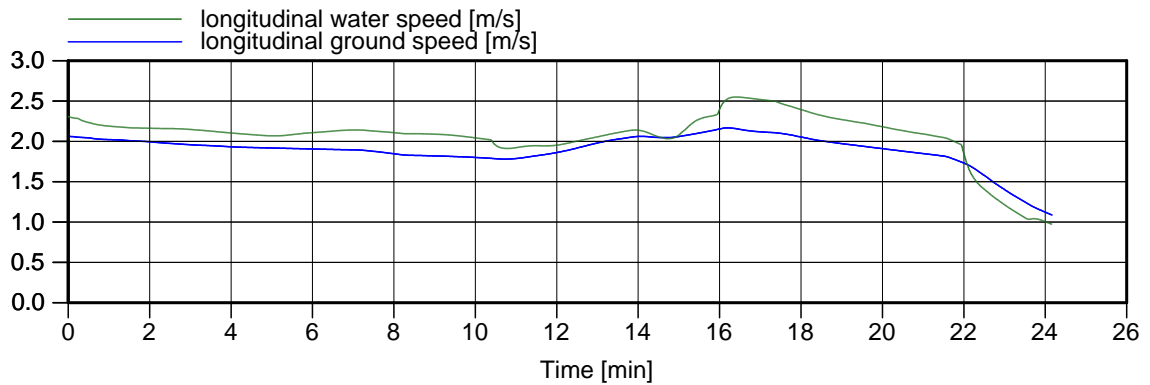
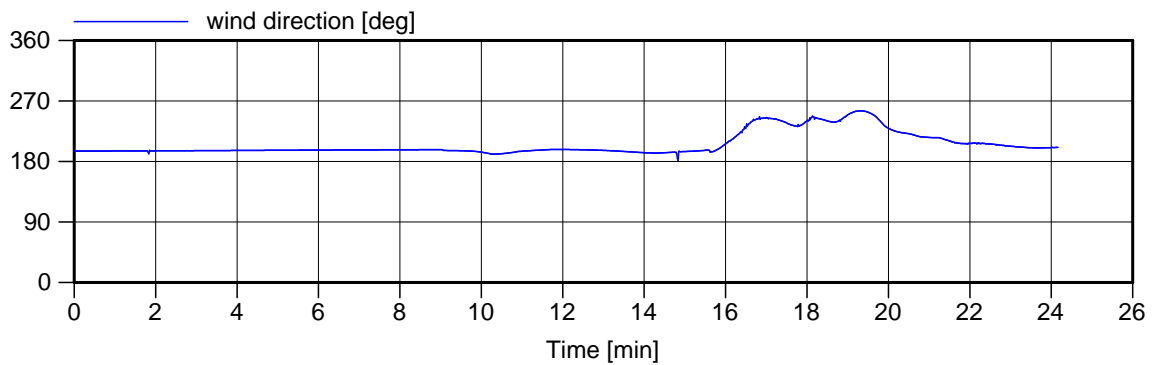
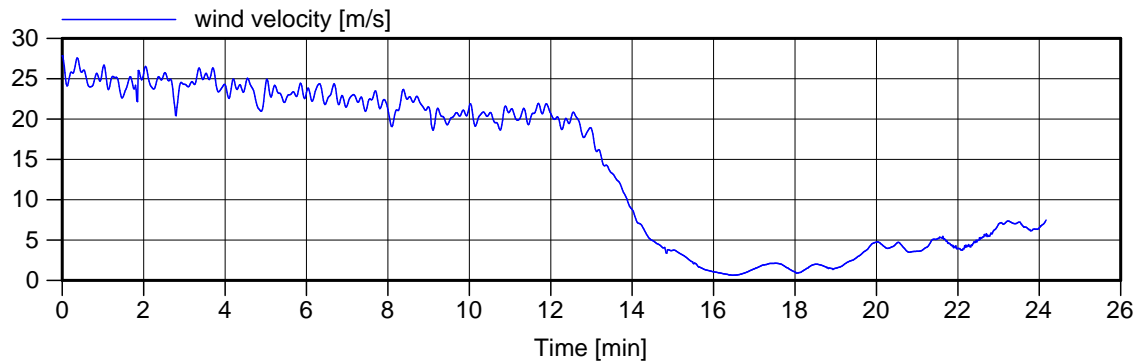

Environment

Run: 18-23 Arr

Ship: Capesize 292x45x18.5

Wind: SSW 15.5 m/s

Current: Ebb max f1.3

Figure: 23.b

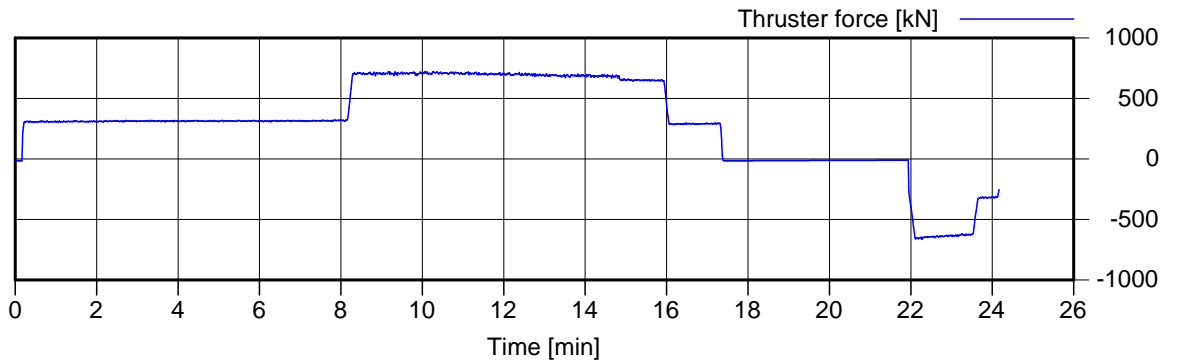
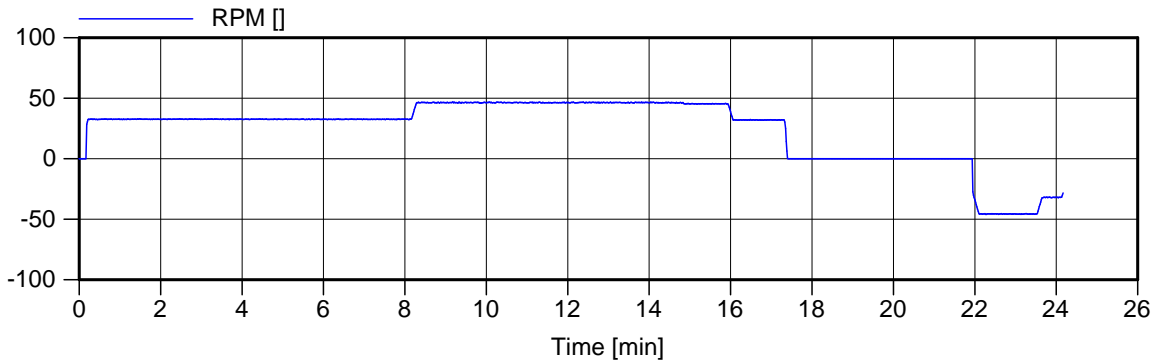
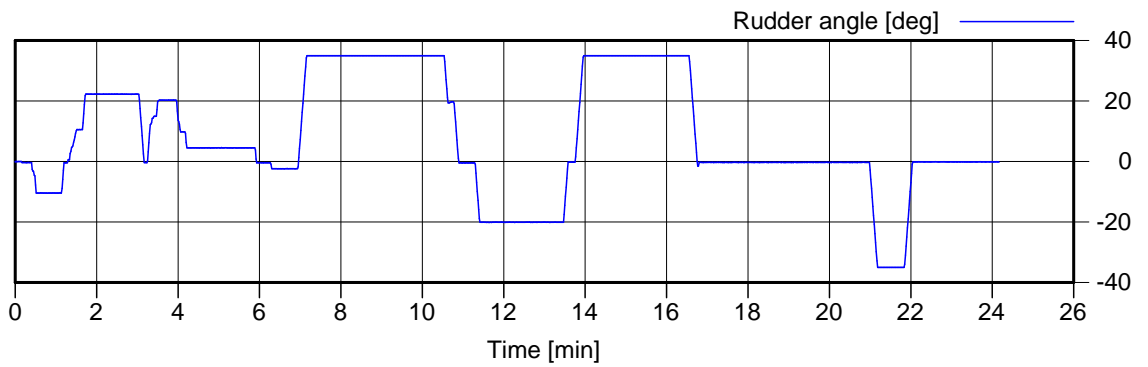
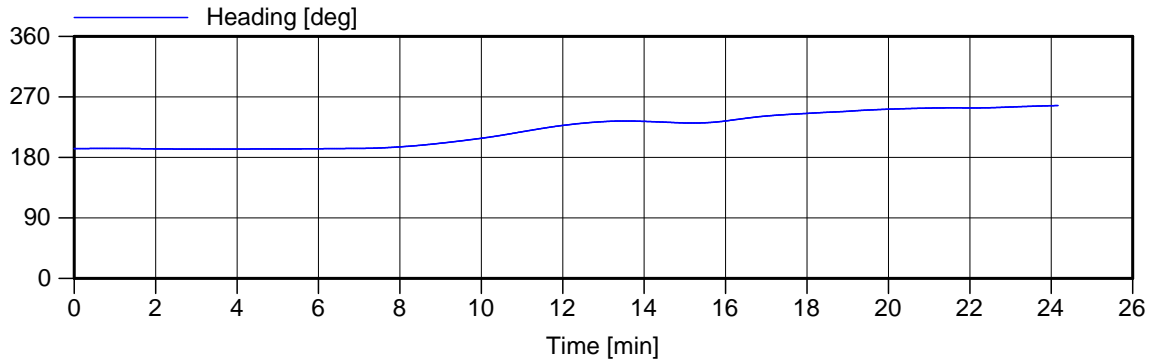

Ship data 1	Run: 18-23 Arr
Ship: Capesize 292x45x18.5	Wind: SSW 15.5 m/s
Current: Ebb max f1.3	Figure: 23.c

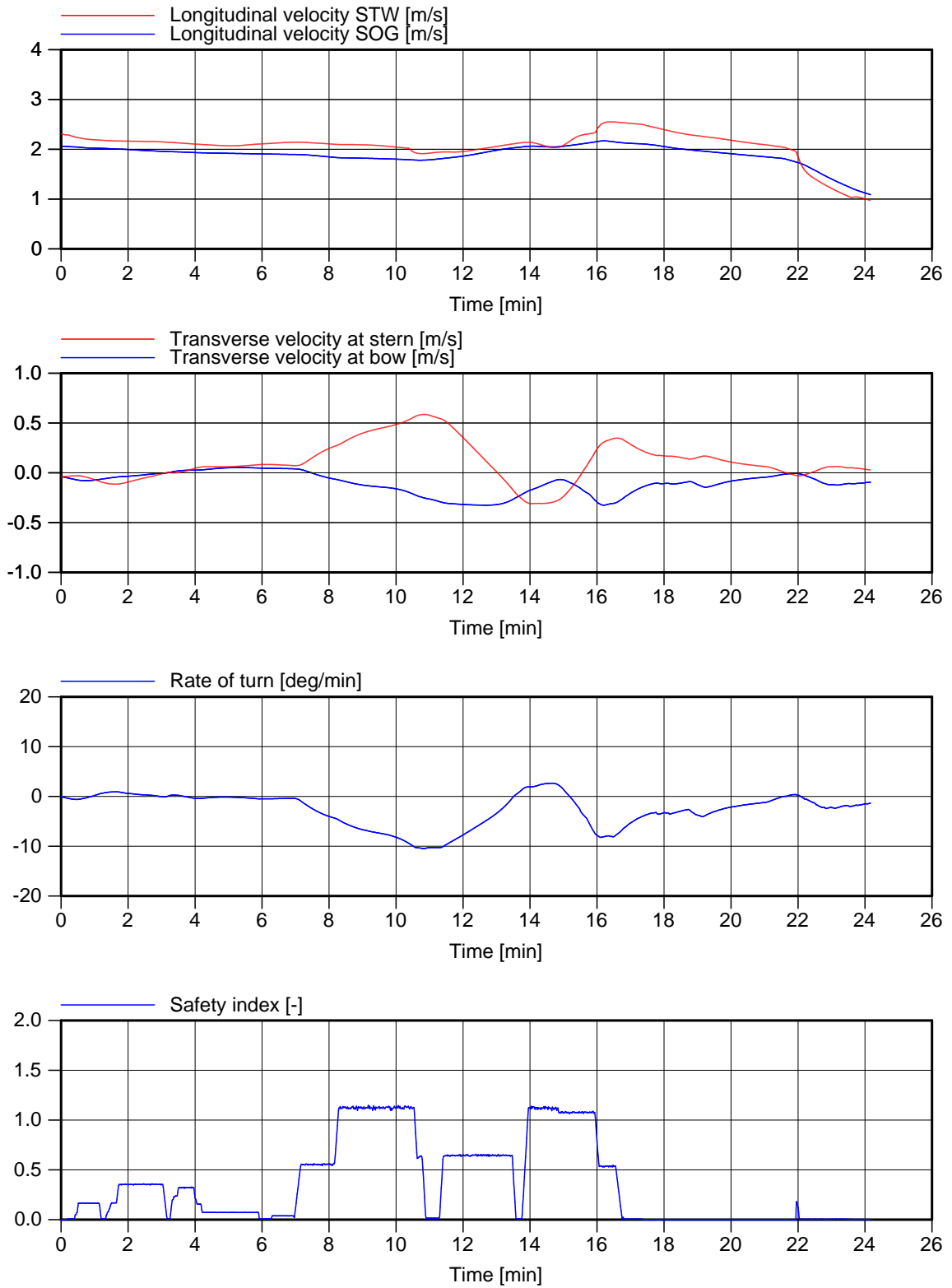

Ship data 2

Ship: Capesize 292x45x18.5

Current: Ebb max f1.3

Run: 18-23 Arr

Wind: SSW 15.5 m/s

Figure: 23.d

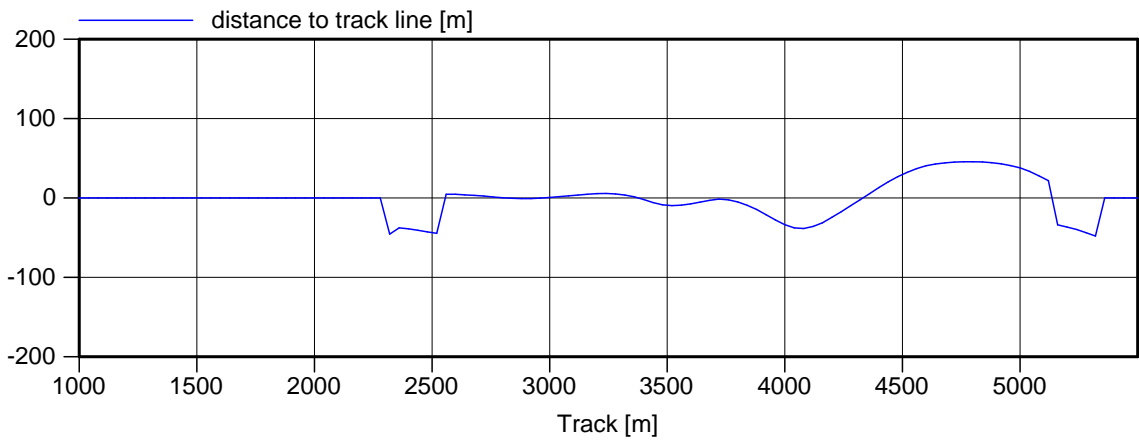
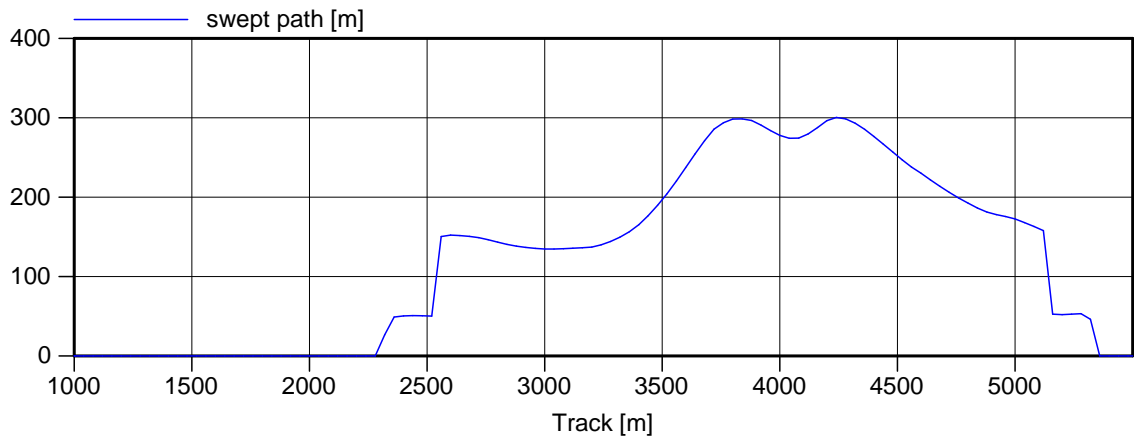

Space used	Run: 18-23 Arr
Ship: Capesize 292x45x18.5	Wind: SSW 15.5 m/s
Current: Ebb max f1.3	Figure: 23.e

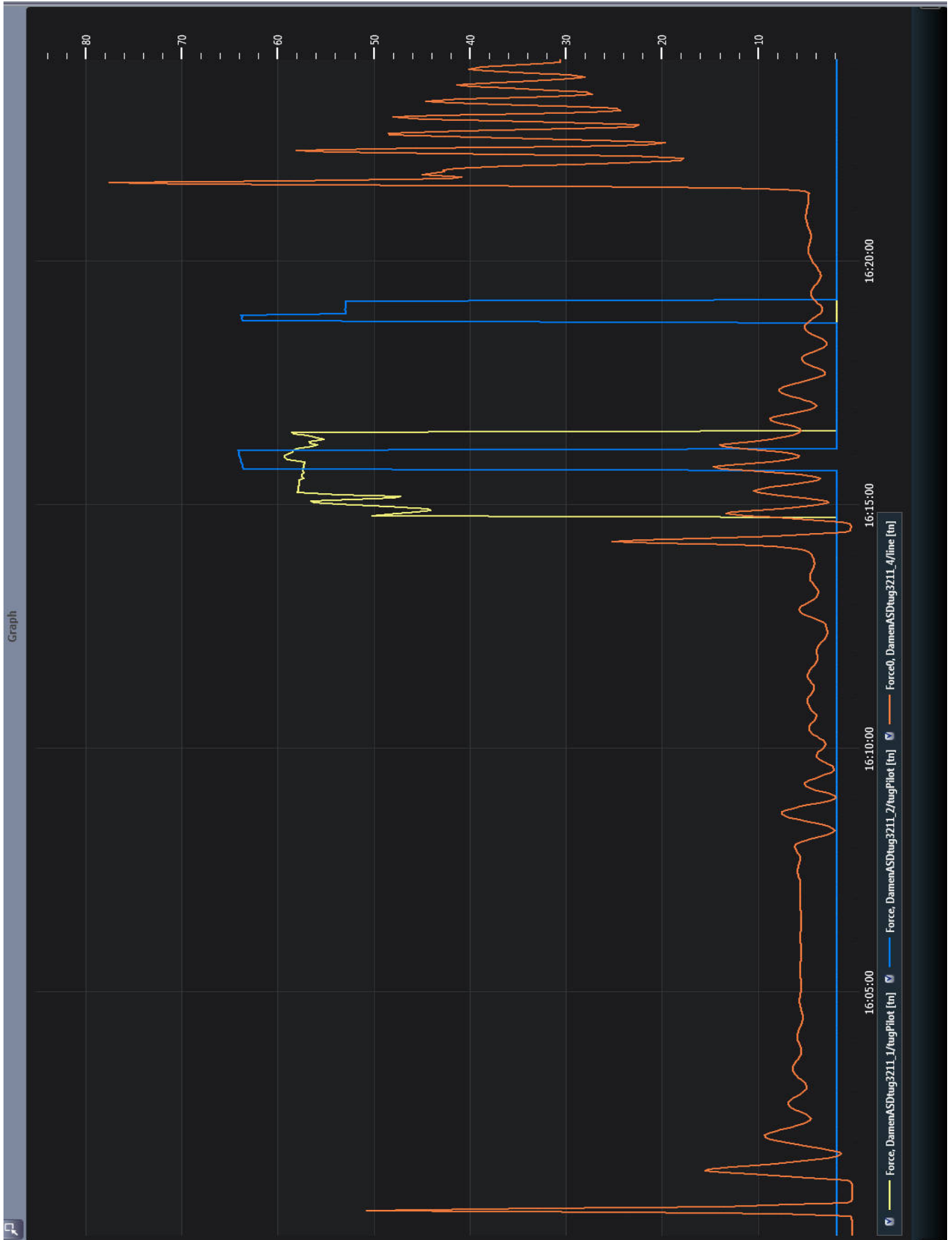

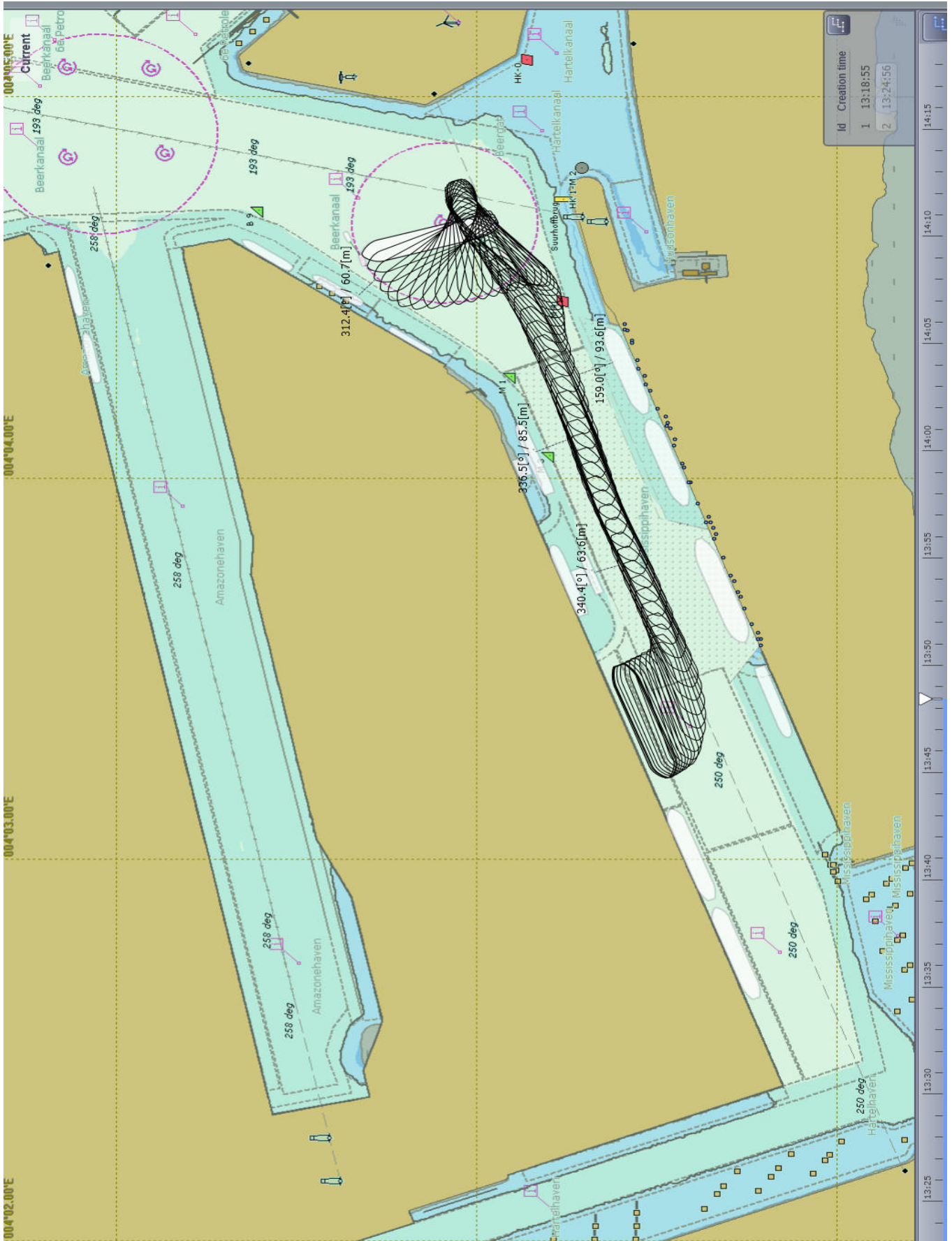

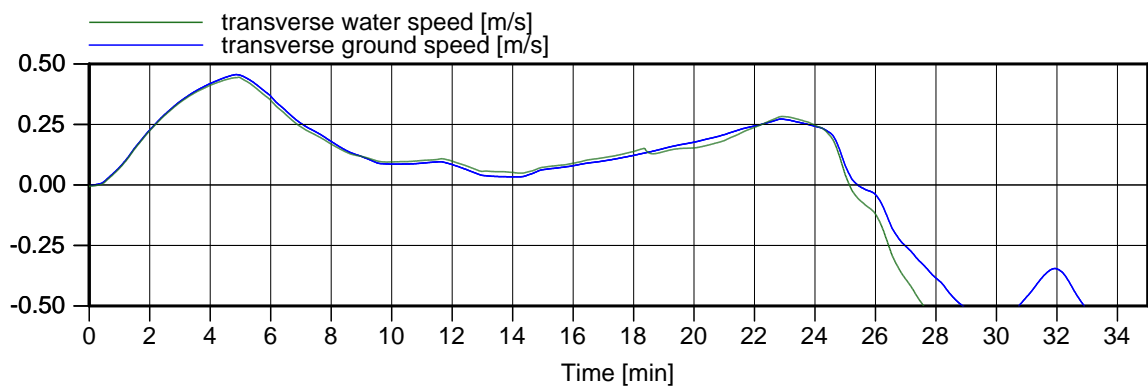
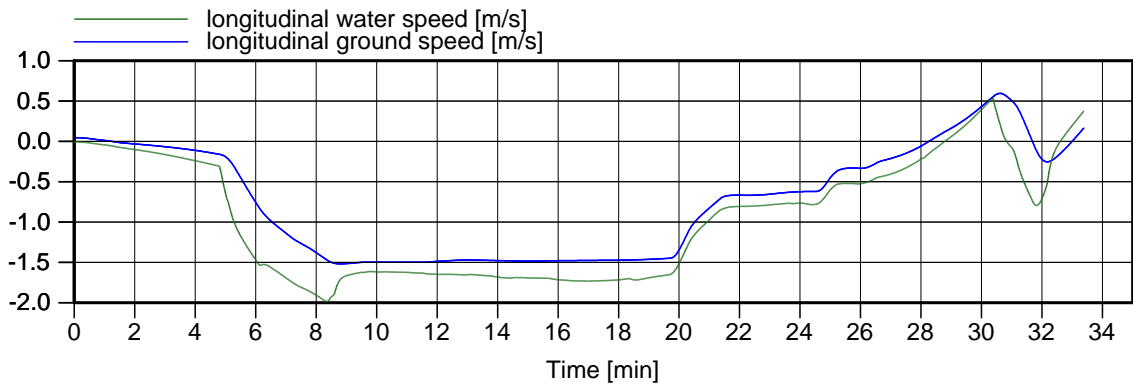
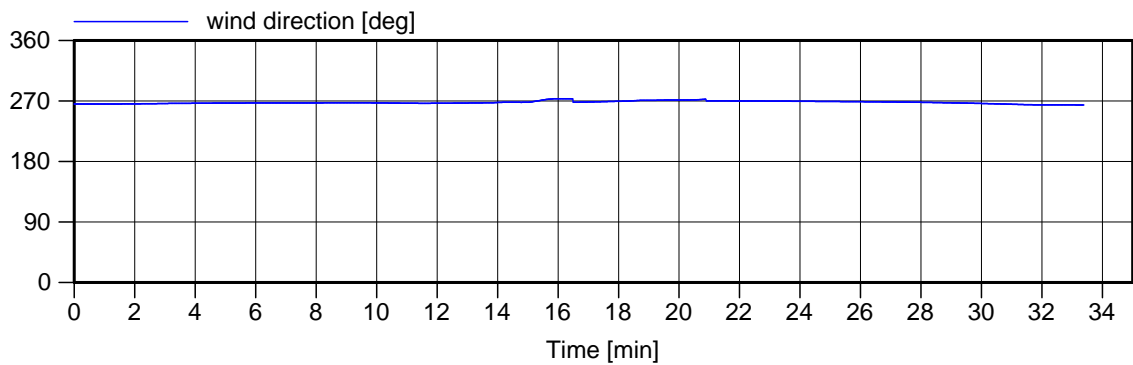
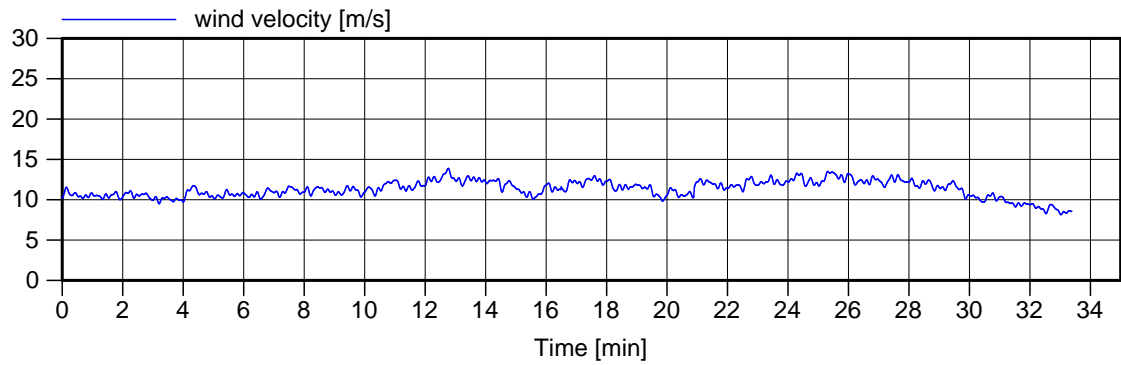

Environment

Run: 18-24 Dep

Ship: Valemax 362x65x14.0

Wind: W 15.5 m/s

Current: Slack HW

Figure: 24.b

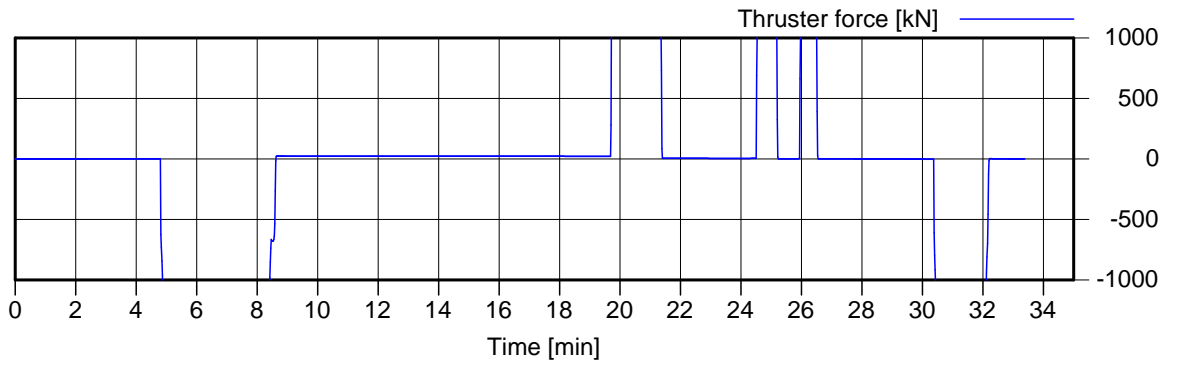
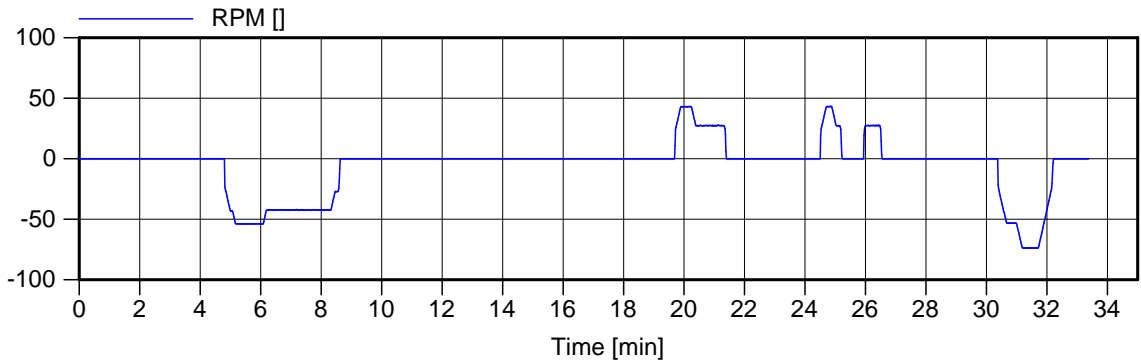
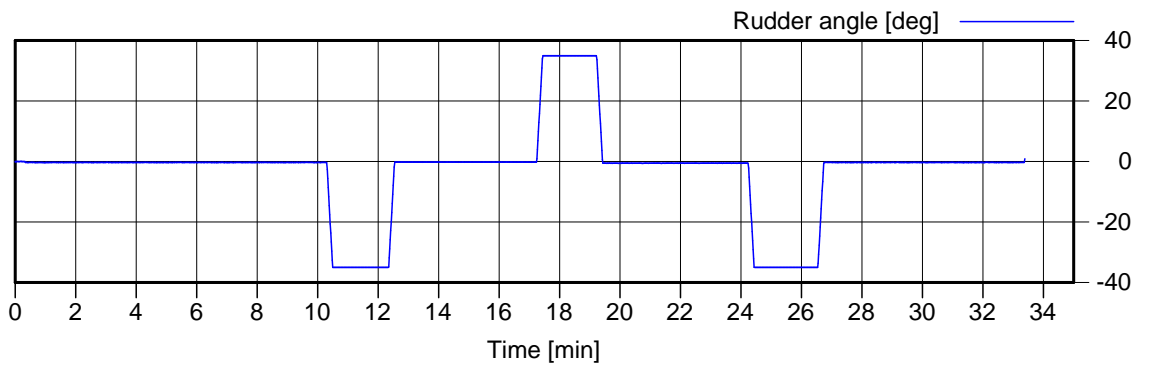
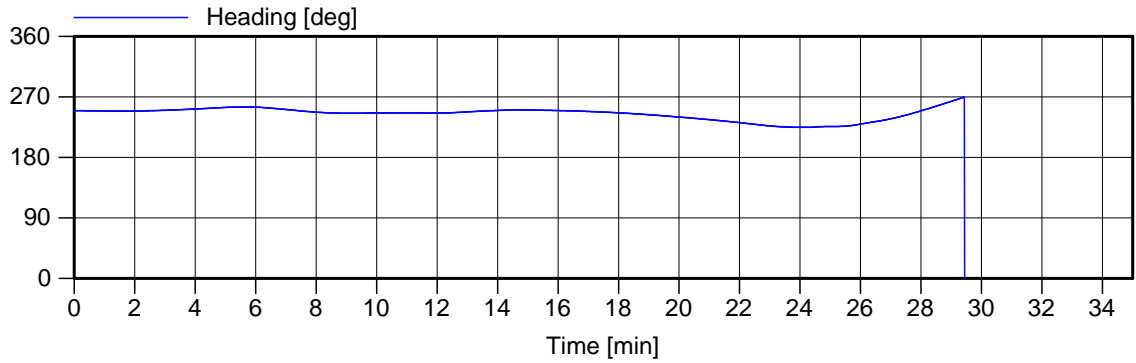

Ship data 1	Run: 18-24 Dep
Ship: Valemax 362x65x14.0	Wind: W 15.5 m/s
Current: Slack HW	Figure: 24.c

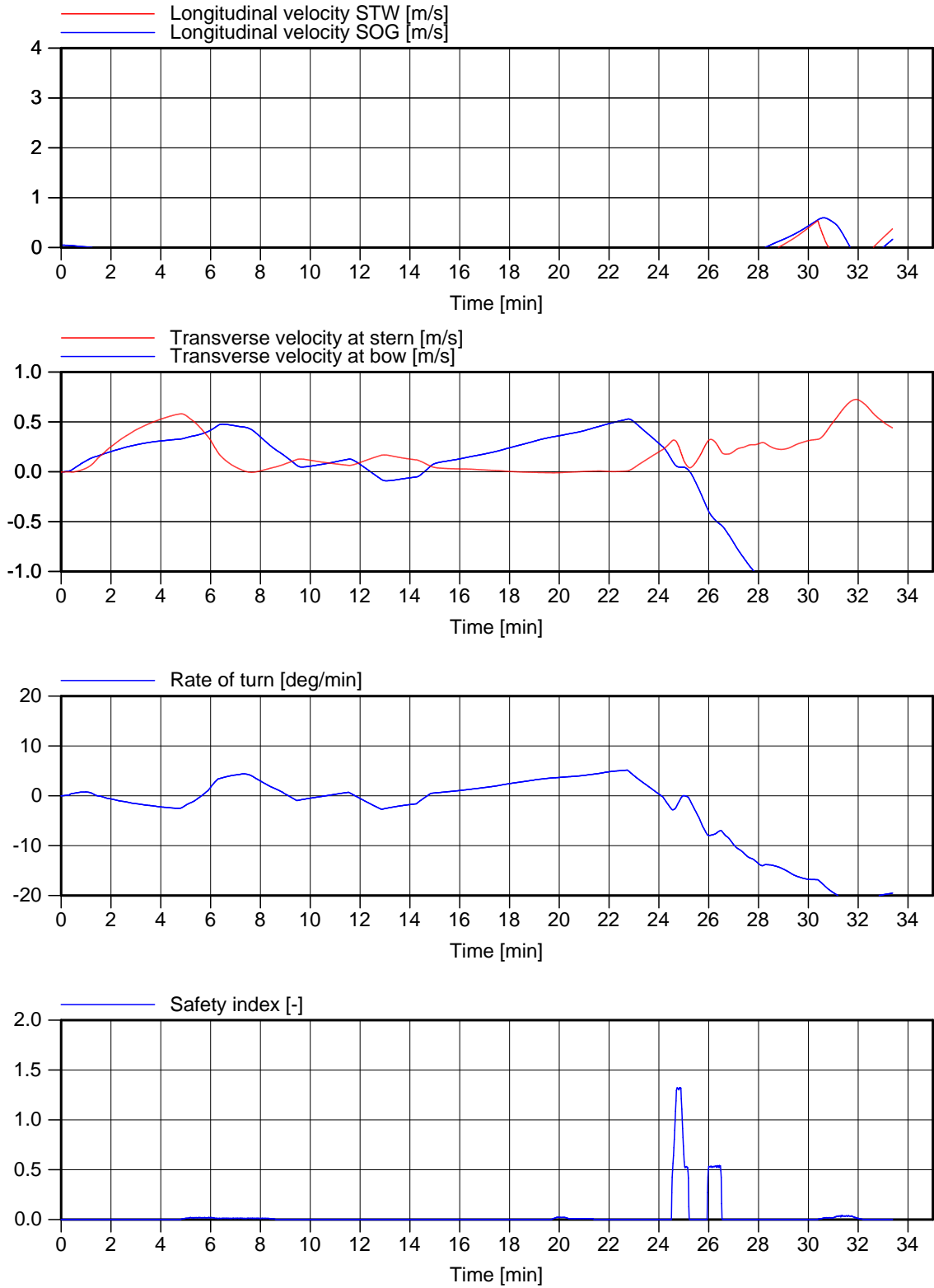

Ship data 2	Run: 18-24 Dep
Ship: Valemax 362x65x14.0	Wind: W 15.5 m/s
Current: Slack HW	Figure: 24.d

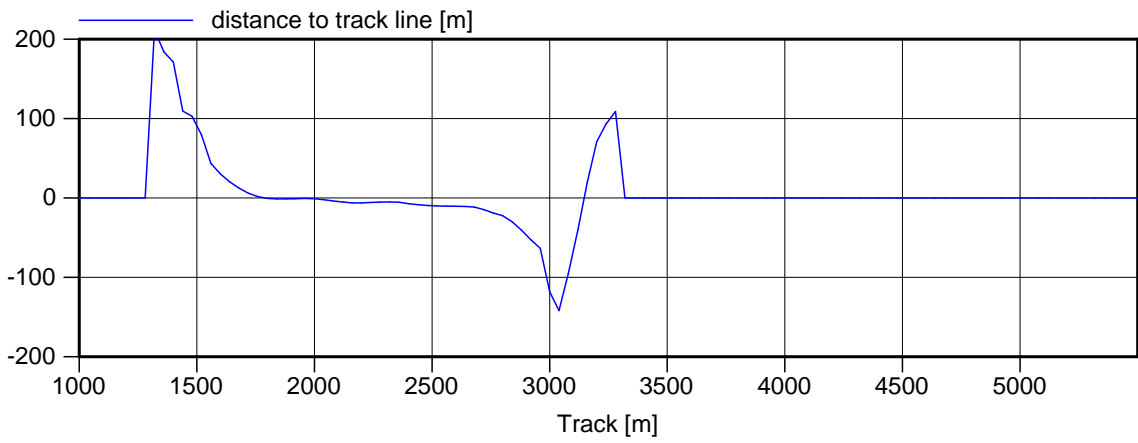
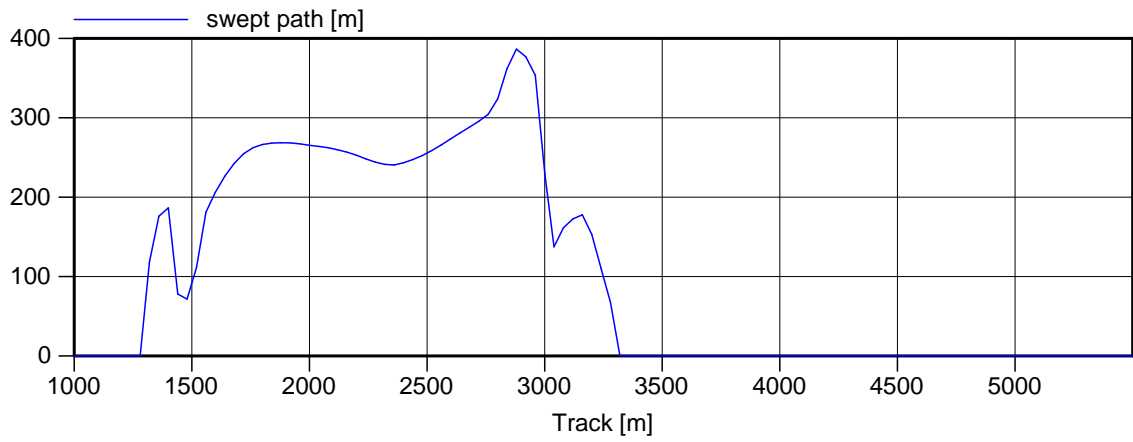

Space used

Run: 18-24 Dep

Ship: Valemax 362x65x14.0

Wind: W 15.5 m/s

Current: Slack HW

Figure: 24.e

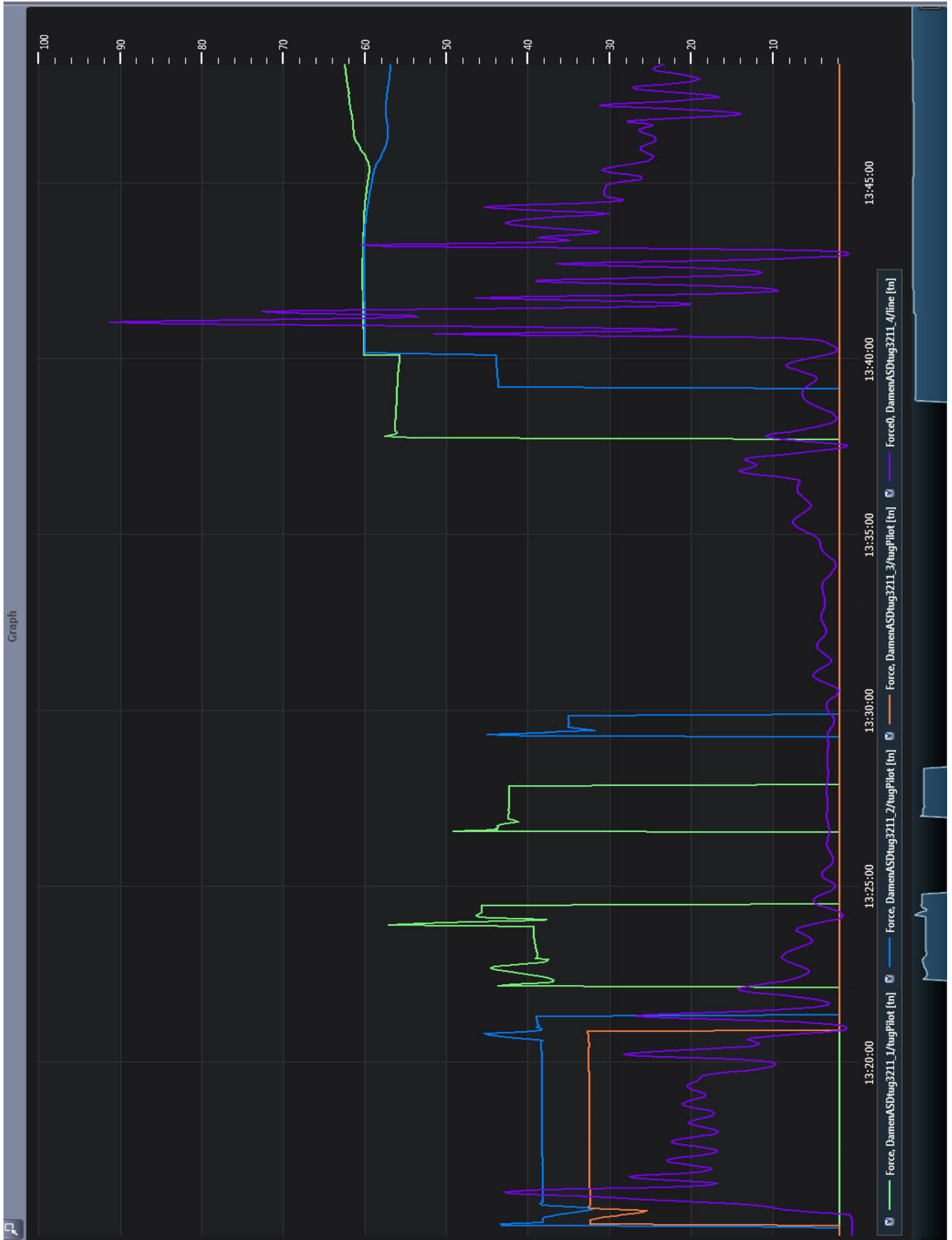

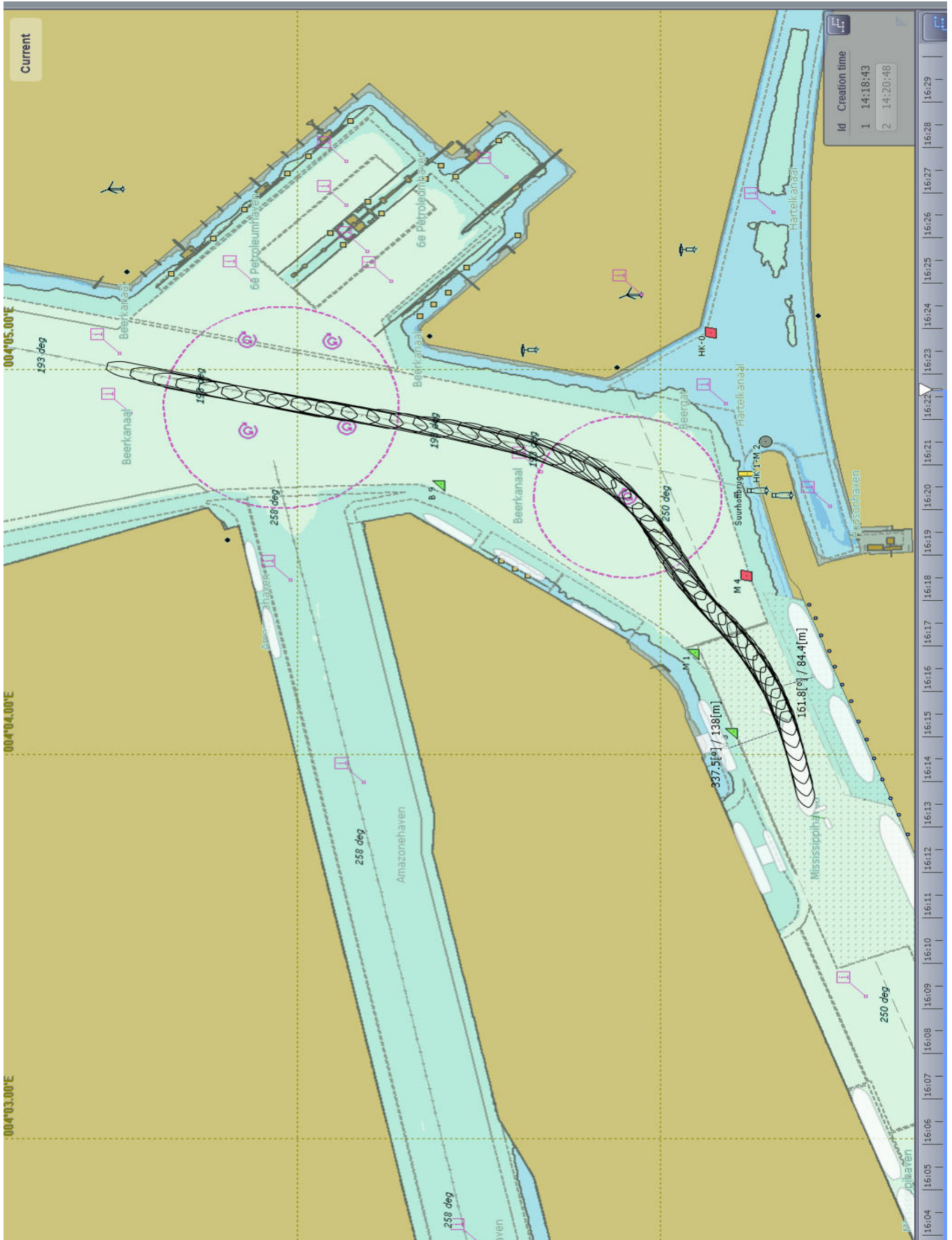

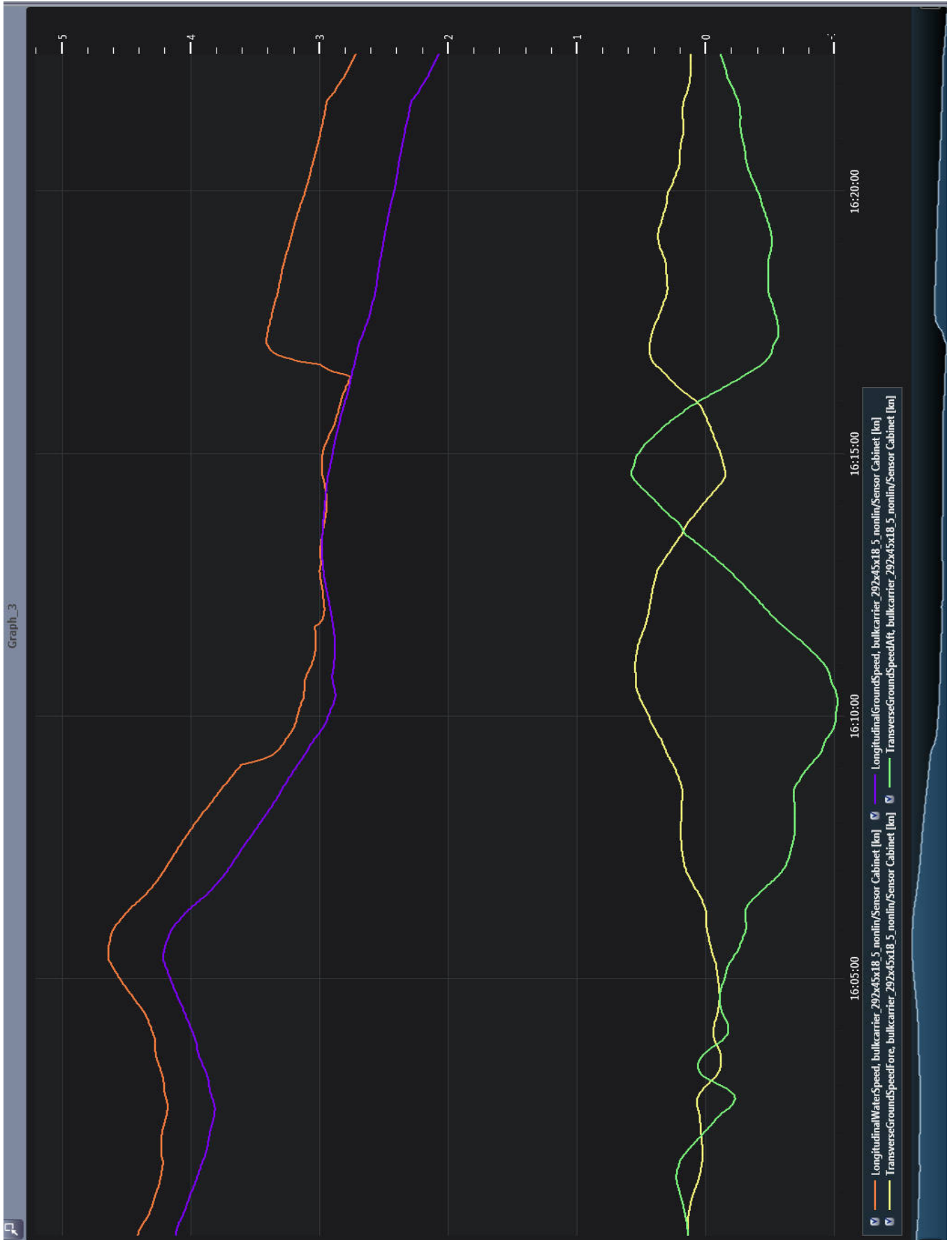

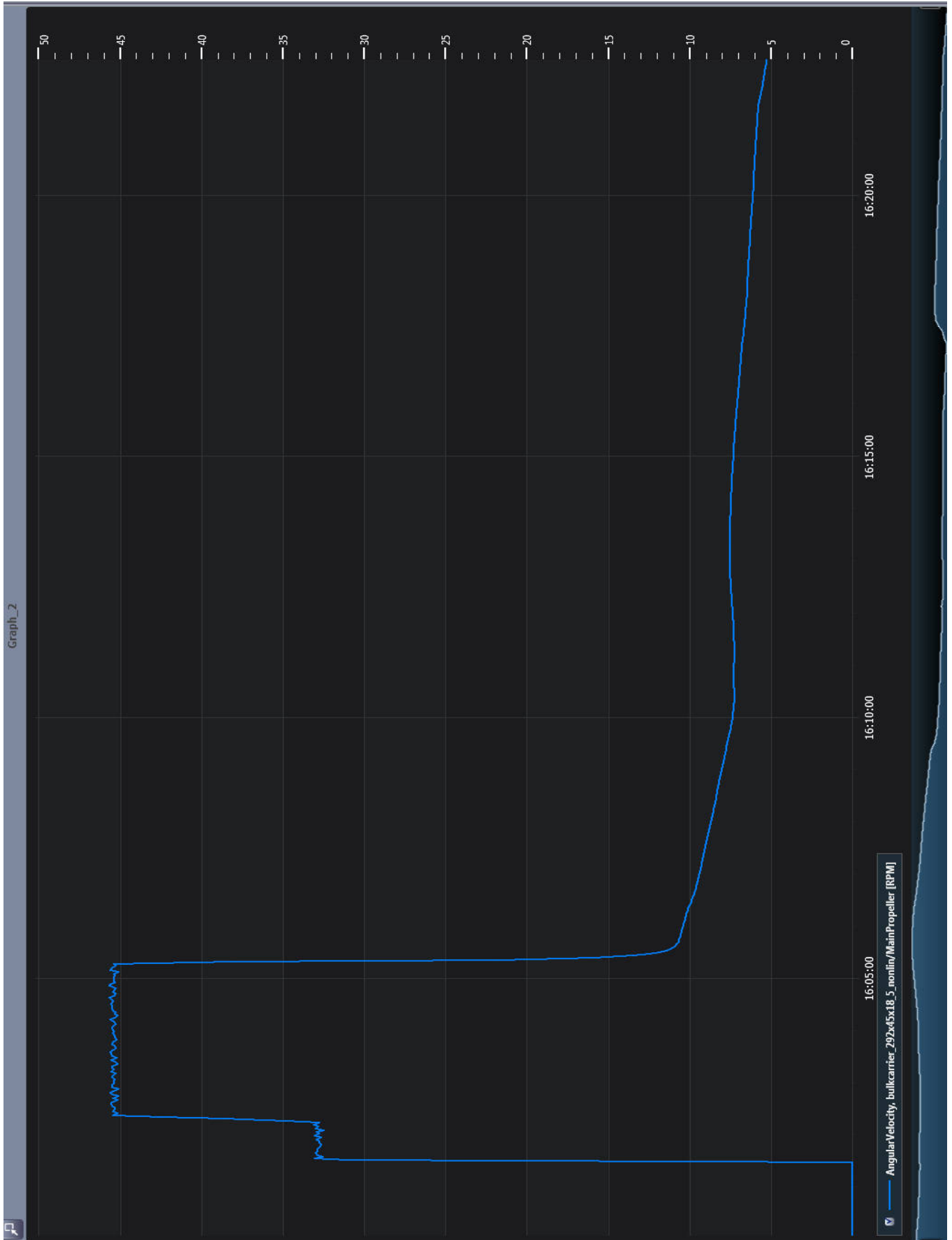

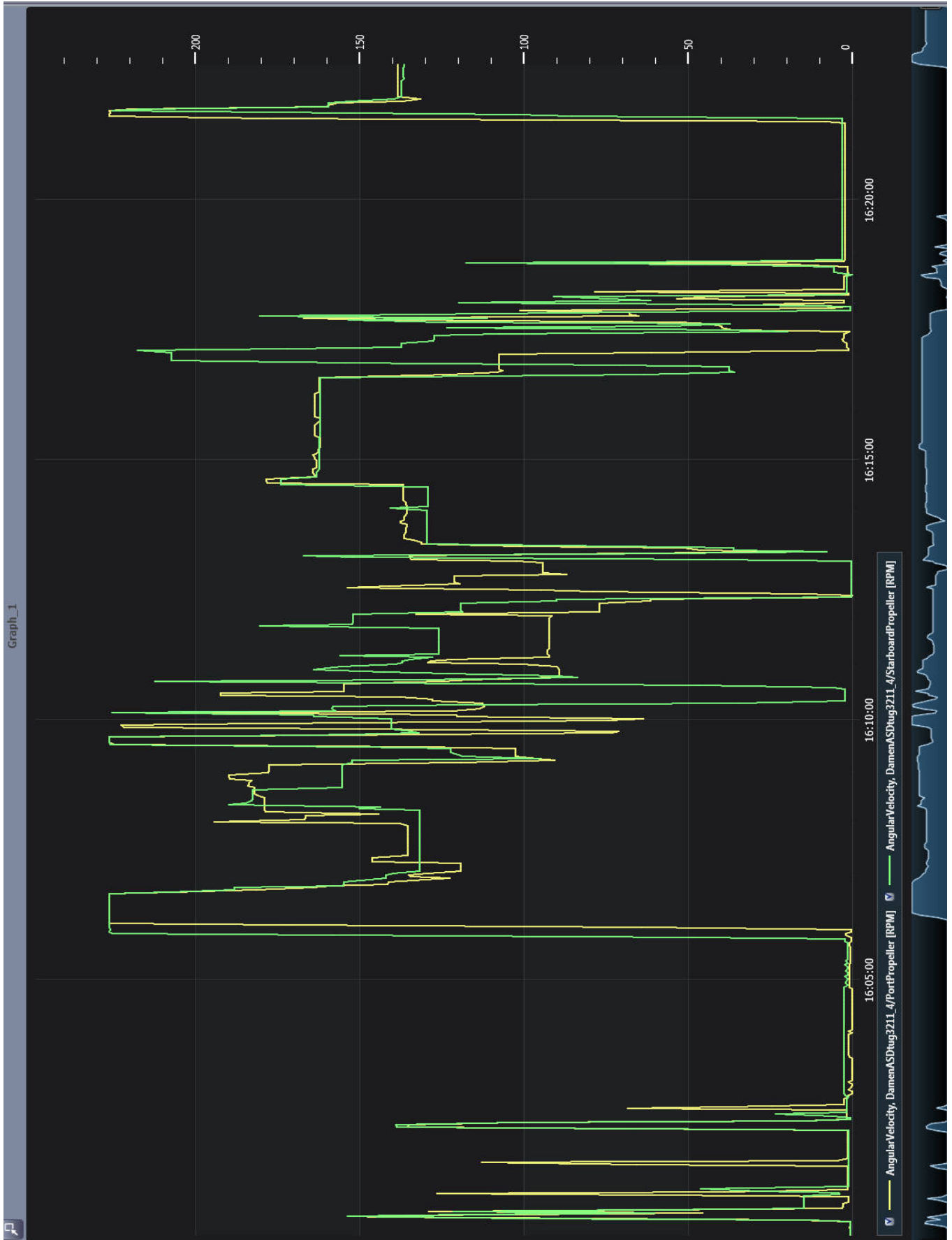

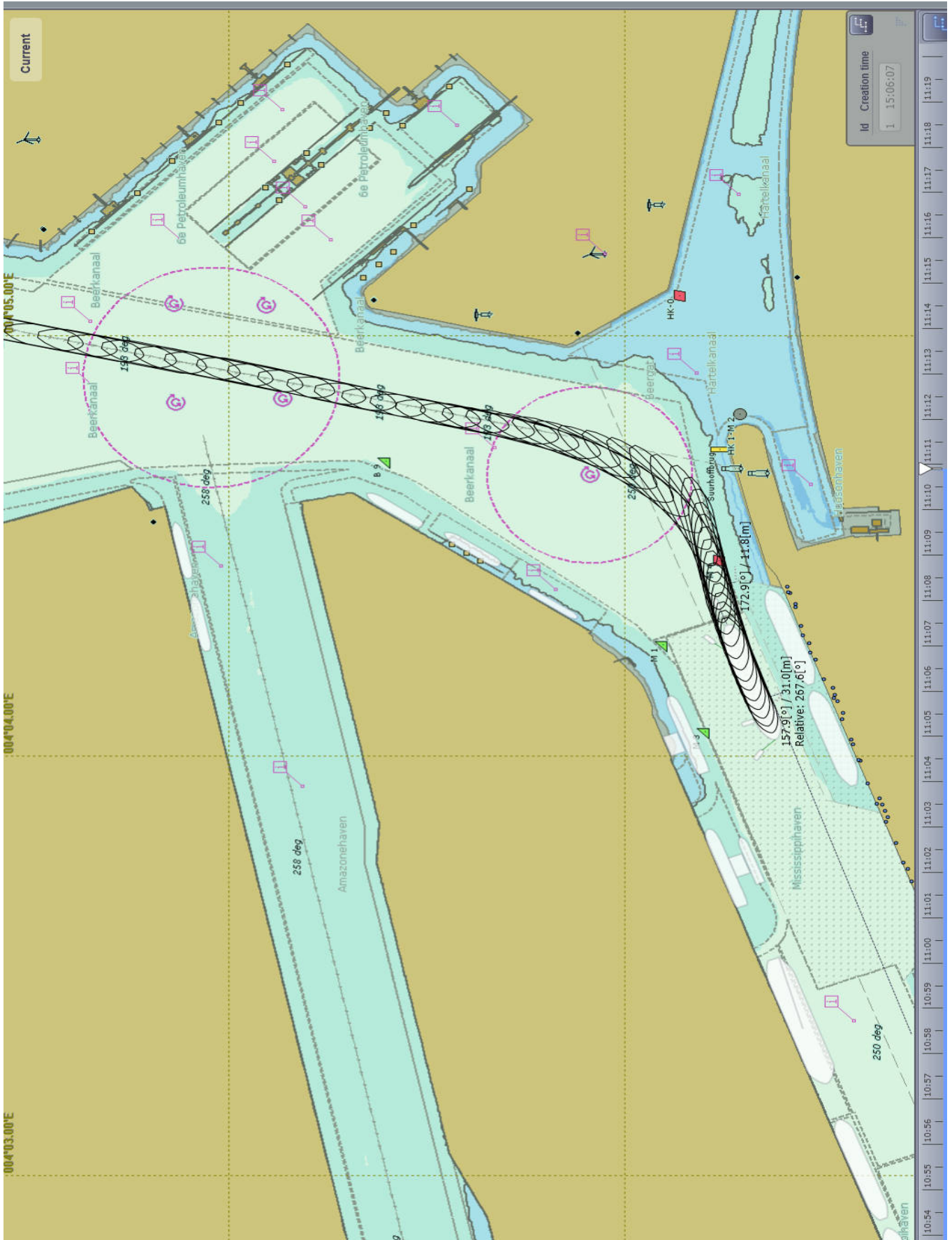

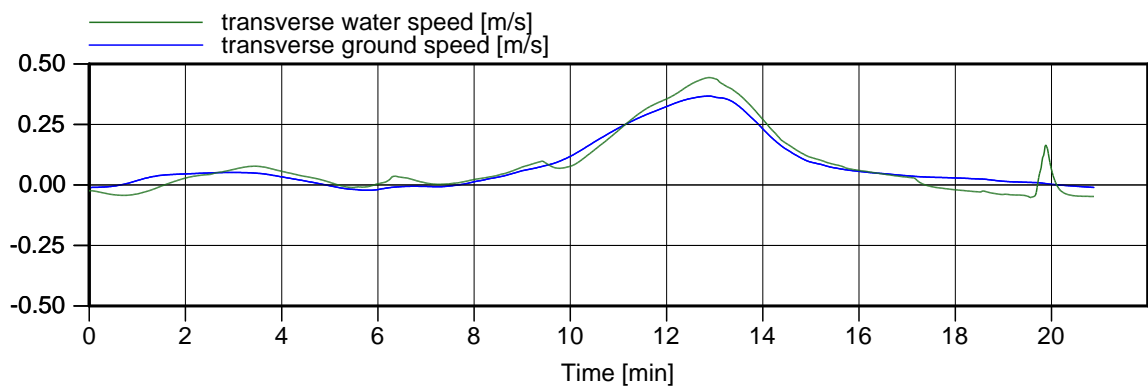
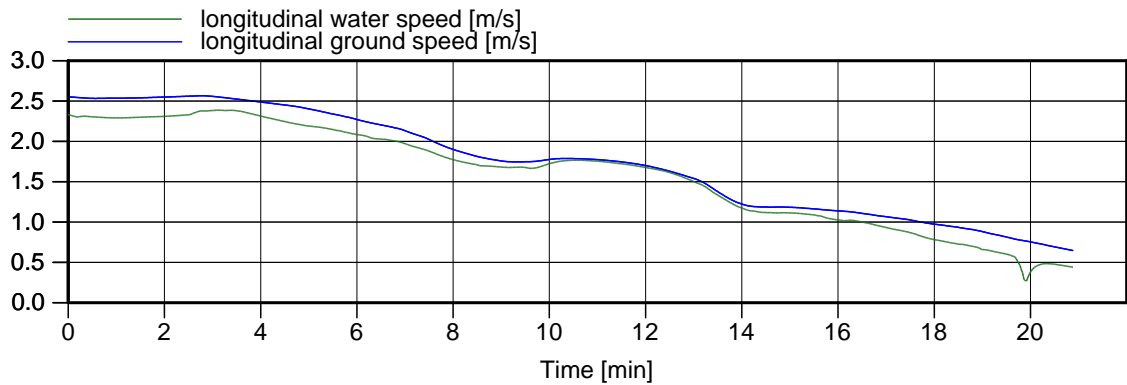
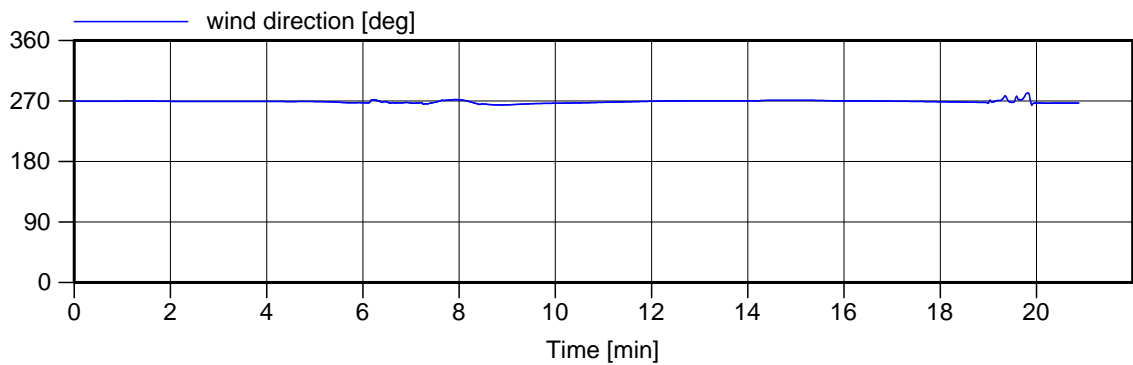
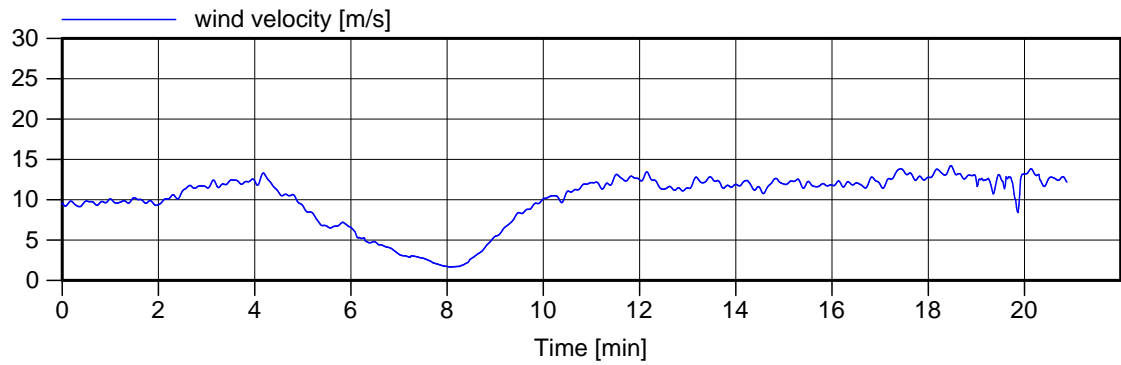

Environment

Run: 18-26 Arr

Ship: VLCC 332x58x21.0

Wind: W 15.5 m/s

Current: Ebb max f1.3

Figure: 26.b

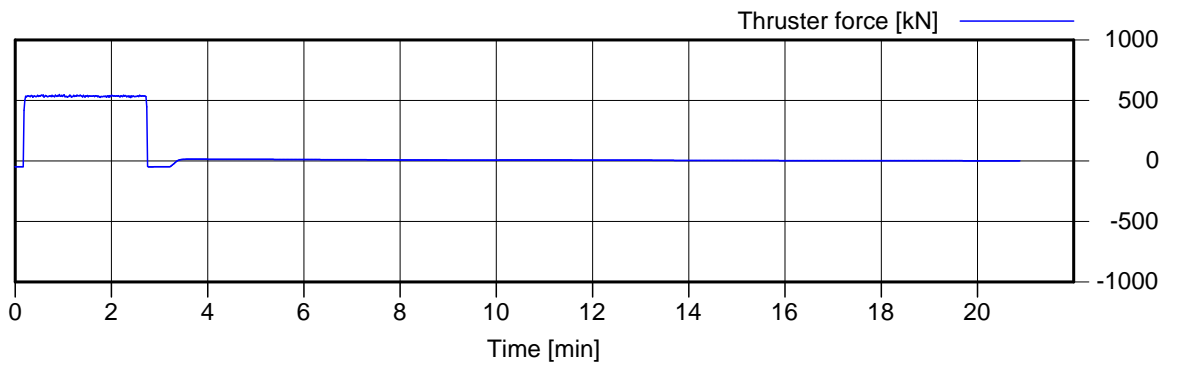
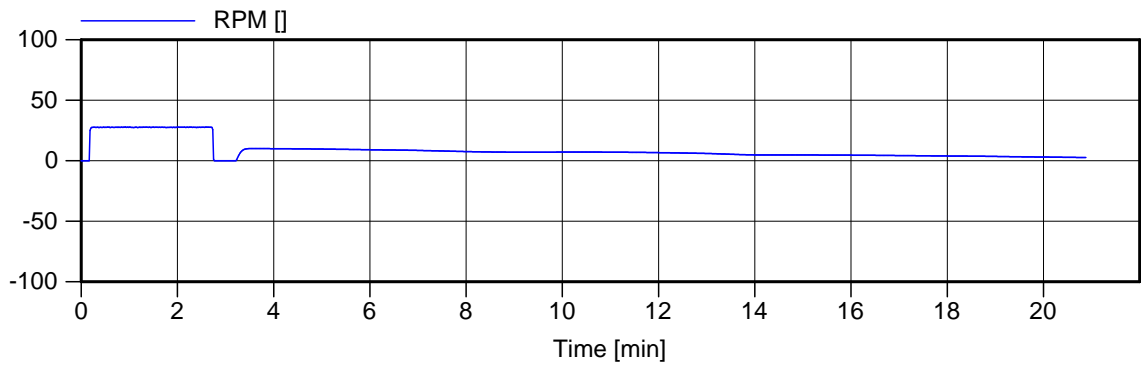
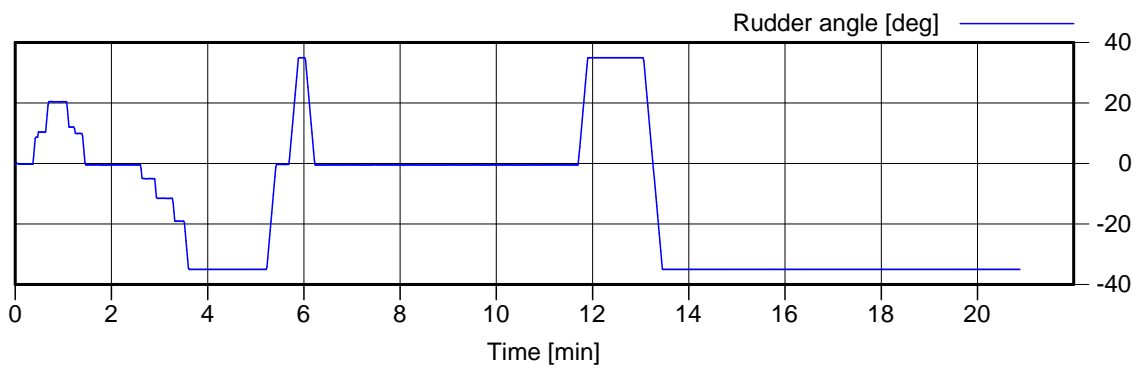
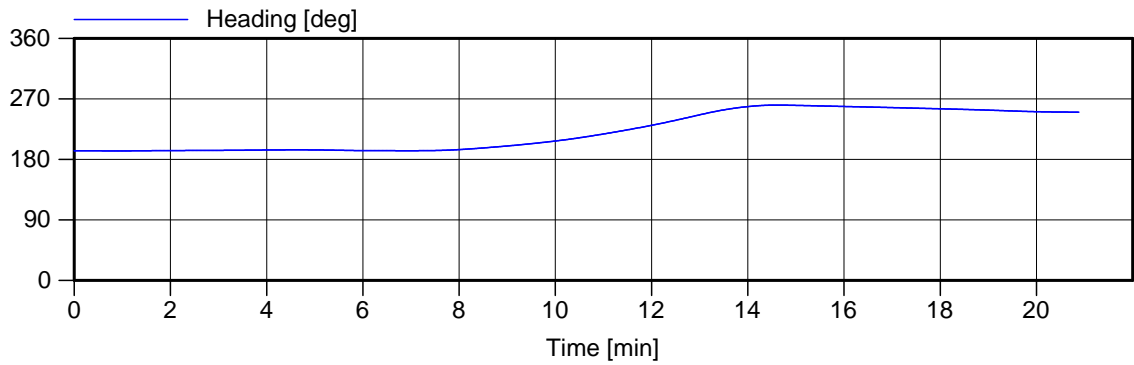

Ship data 1

Ship: VLCC 332x58x21.0

Current: Ebb max f1.3

Run: 18-26 Arr

Wind: W 15.5 m/s

Figure: 26.c

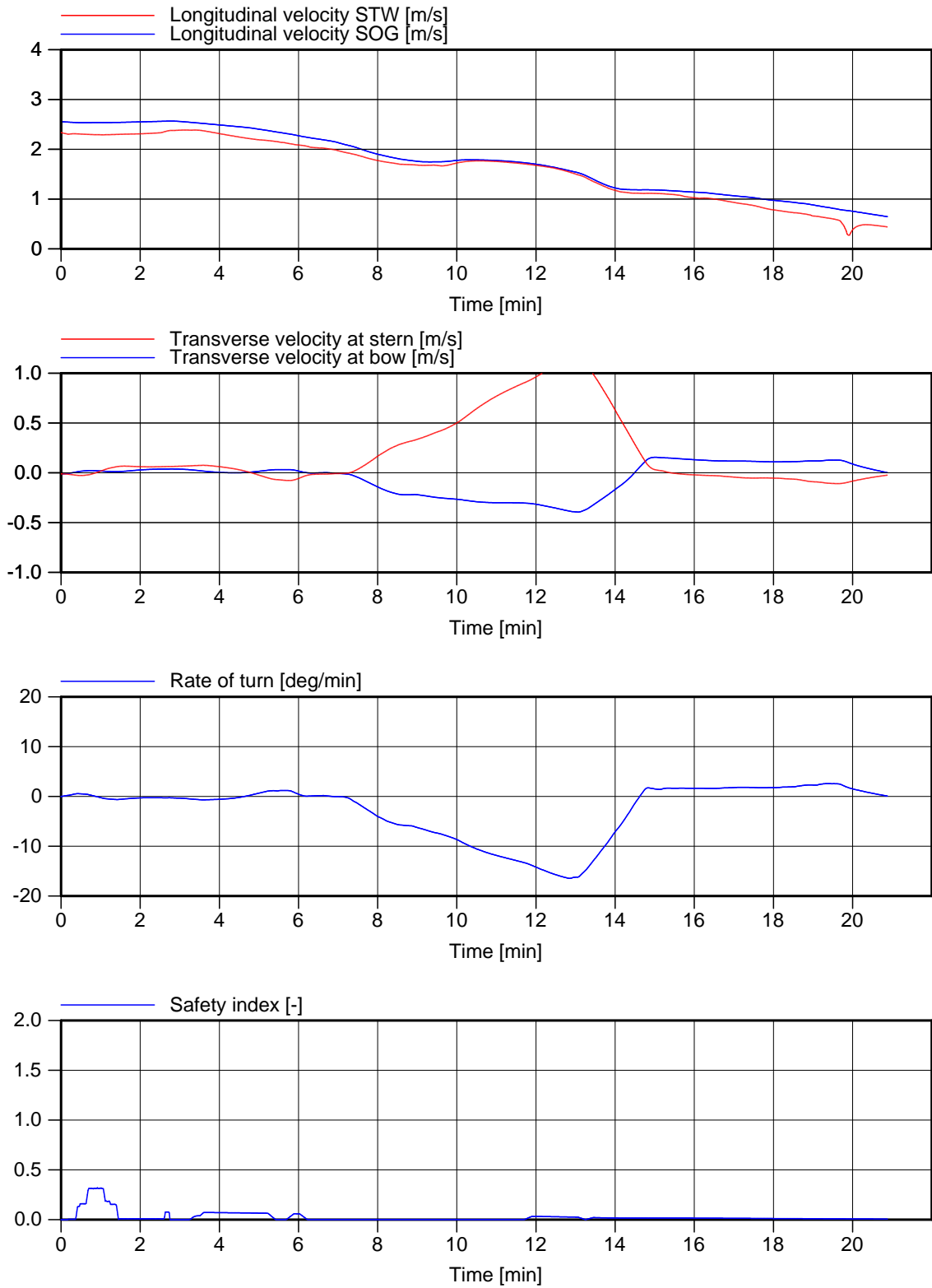

Ship data 2

Ship: VLCC 332x58x21.0

Current: Ebb max f1.3

Run: 18-26 Arr

Wind: W 15.5 m/s

Figure: 26.d

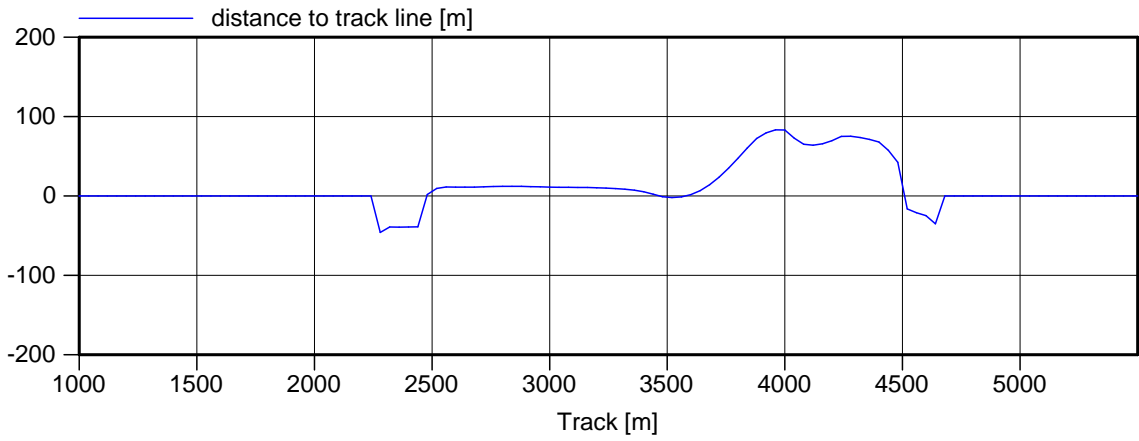
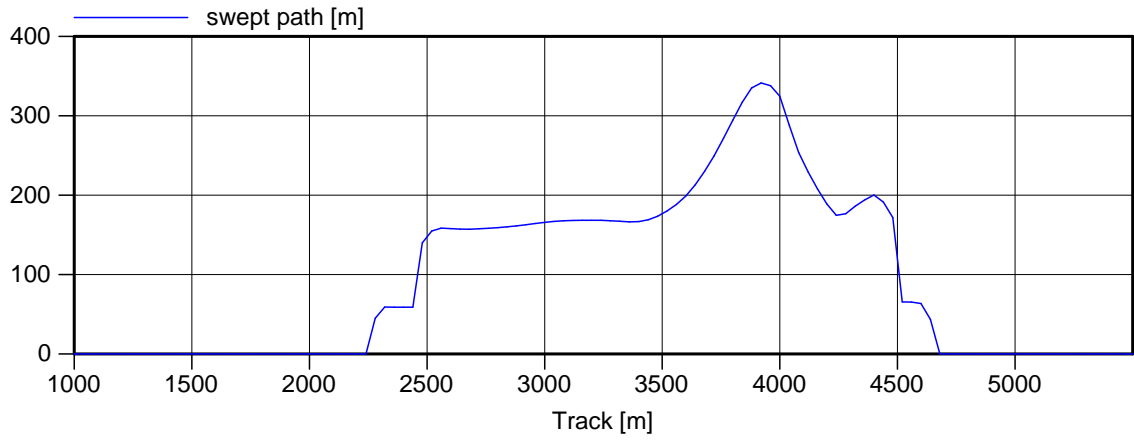

Space used	Run: 18-26 Arr
Ship: VLCC 332x58x21.0	Wind: W 15.5 m/s
Current: Ebb max f1.3	Figure: 26.e

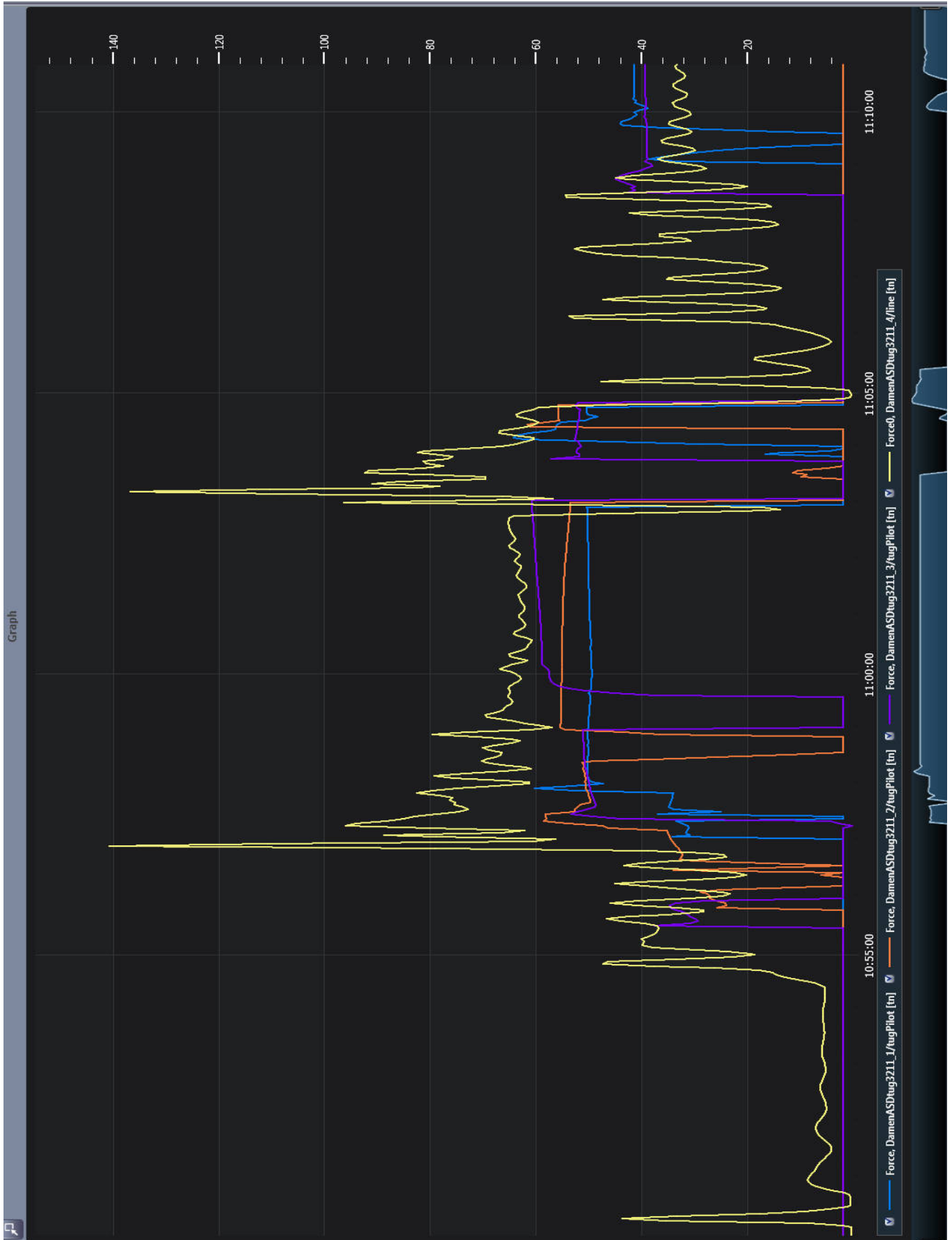

APPENDIX D Assessment by simulator instructor

Marin Project 29266 Mississippi Haven Rotterdam

Simulations February 16th to 18th 2016.

Tuesday February 16th 2016.

Run	Conditions	Particulars	Remarks & Recommendations	Rating
16-1	Capesize T 18,5 Start time 07.15 Ebb SSW 10m/s Familiarisation	The visuals are a bit dark, because of the set time of the day. The ship is more difficult to handle in the 1 knot current, during the turn. However, the turn has been performed well controlled without the use of excessive power of engines and tugs.	Change date (to summer) will solve the problem with the dark visuals.	++
16-2	Capesize T 18,5m Start time 14.45 Ebb SSW 15 m/sec	Simulator crashed: Several scenarios were started. Engineers solved the problem.		
16-3	Capesize T 18,5 Start time 14.45 Ebb SSW 15 m/sec Curr. 1,0 kt Start time 14.45 Sim Start 10.29 Sim Stop 10.53	At 14.54 an engine failure was initiated. The pilot managed to keep the ship under control, without using excessive force from tugs. Discussed the positions of the forward tugs, but considered not relevant for this feasibility study.	Positions of the tugs will differ anyhow during the VLCC scenarios yet to be performed	+
16-4	Capesize T 18,5m Start time 11.50 Flood Max NW 15 m/sec Sim Start 11.26 Sim Stop 11 48	At 11.59 an engine failure was initiated. The pilot managed to control the situation. Did not use excessive tug forces.		+
16-5	Capesize T 18,5m Start time 11.50 Flood Max NW 15 m/sec Sim Start 11.56 Sim Stop 12.14	At 11.59 an engine failure was initiated. The pilot managed the situation. Simulator problem: C-tugs cannot be disconnected. The force vector does not seem to work. But nevertheless the ship became under control.		+
16-6	VLCC T 21 m Start time 11.50 Flood Max SSW 15 m/sec Sim Start 13.33 Sim Stop 14.00	At 11.54 an engine failure was initiated. The pilot managed the situation and used the tugs in a very efficient way. Passed the turn to starboard fully in control. Pilot did not use more than 75% power of the tugs. In the end, in order to stop the vessel, the aft tug was used 100% for a short period of time		+

16-7	VLCC T 21m Start time 11.00 NW 15 m/sec Sim Start 14.28 Sim Stop 15.00	Start time set at 11.00 in order to create the highest possible flood current at the turning circle at the basin's entrance. Engine failure at 11.06. The pilot attempted to control the speed by using 3 tugs and once he achieved 3.5 knots, he decided to make the turn. This scenario has to be considered as "on the limit" Redundancy is a point of discussion.	Especially for this situation the different levels of current should be studied, in order to determine whether the already existing limits should be reconsidered	+-
16-8	Valemax T 22,5m Start Time 11.00 W 15,5 m/sec Sim Start 15.25 Sim Stop 15.56	Start time set at 11.00 for highest current rate. Initial speed was set to 5 kn. (SOG) to make it more complicated. Pilot performed an excellent job and controlled the manoeuvre without the use of excessive power of engine and tugs.		++
16-9	Valemax T 22,5m Start Time 11.00 SSW 15,5 m/sec Sim Start 16.34 Sim Stop 17.04	And also this run went very controlled, using up to a maximum of 75% tug force and the engine at DSA. From 11.18 hrs 2 "D Forces" were in use as substitute of two tugs on port side (Fore and Aft)	D Forces worked properly	++

Wednesday February 17 2016.

17-10	Valemax T 14 m Dep. Start Time 13.15 Slack NW 15,5 m/sec Sim start 09.00 Sim start 09.38	Started the run, with the ship just of the berth. The pilot decided to turn the vessel at the circle at 6 th Petroleum harbour. Very controlled "stern sailing" stretch. Safe manoeuvre with civilised use of tugs and engine		++
17-11	Valemax T 22,5 Arr. Turn Start Time 09.30 Slack Ebb SSW 15,5 m/sec Sim Start 10.07 Sim Stop 11.03 Video 029	Pilot started to reduce the speed and made a controlled turn at the entrance of the Miss. Haven. He had to use full power of the forward tugs for approximately 2 minutes. Started a controlled "stern wise in" manoeuvre and even after an emergency (aft tug break down) the ship proceeded without any difficulties.	Starboard side tug did not work, used DForce D Force SB Fore 45 t 9.43.45 to 09.44.10 inw. 45 t 9.48.57 to 09.52.50 out 45 t 10.00.40 to 10.06.10 out 45 t 10.08.00 to 10.09.47 inw	++
17-12	Capesize T 18,5 Arr. Turn Start Time 09.25 Slack Ebb SSW 15,5 m/sec Sim Start 11.26 Sim Stop 12.20 Video 030	Start time was chosen in order to simulate a (too) early arrival. A controlled turn until the forward tug failed. Ship started to drift to port, but the pilot managed to stay in control and solved the problem, using full power on starboard forward tug and no more than 75% on any of the remaining tugs. This way of turning, same		++

		as in run 11, is always giving the opportunity to abort and escape in a controlled way.		
17-13	Capesize T 18,5 Arr Start 10.50 Max Flood NW 15,5 m/sec Sim Start 13.22 Sim Stop 13.45	This trip does not cause any problems. Minimum use of tugs during the turn to starboard. Speed controlled to 3,4 kts (SOG)		++
17-14	Valemax Arr FLOWINT. Start Time 13.15 Ebb start SSW 15,5 m/sec Sim Start 13.53 Stop Sim 14.16	Technically no problem, although ebb tide started to run. Interaction forces on the moored vessels showed up as moored vessels were pushed into the shoreline.	Fendering between berth and ships has to be corrected.	++
17-15	Capesize T 18,5 Arr Start Time 16.00 Ebb Max. SSW 15,5 m/sec Sim Start 14.28 Sim Stop 14.50	Run under control. Just before turning, the main engine failed. Pilot managed the situation in an excellent manner and brought the ship inside in a very safe way.		++
17-16	Capesize T 18,5 Arr. Start Time 16.00 Ebb Max NW 15,5 m/sec Sim Start 15.08 Sim Stop 15.32	Controlled run until the need of the aft tug became necessary, but unfortunately the tugboat failed. Pilot managed to control the situation and asked to change tug positions. After about 9 minutes the aft tug has been secured and the pilot stayed in control all the time. Redundancy doubtful.	Controlling and handling Safety	+ -
17-17	Valemax Dep. Stern wise out. SSW 15,5 m/sec Start Time 13.30 Sim Start 15.53 Sim Stop 16.14	Pilot left although his PPU did not seem to show the right picture. This manoeuvre went wrong. The replay showed that when the pilot asked to pull the ship to port, the port shoulder tug pushed the vessel into the moored ship, due to an operator error. Therefore this run is qualified invalid.	Fact is also that the forward side tug did not work properly	--
17-18	Valemax Dep. Stern wise out. SSW 15,5 m/sec Start Time 13.30 Sim Start 16.26 Sim Stop 16.55	Now the stern wise manoeuvre went perfect. All the way forward tugs were not needed. Turned over starboard in the turning circle. All well controlled even with wind speeds up to 35 knots from SSW. The Doppler showed 0,7 knots astern and next moment the Doppler showed 1,6 knots forward. Also the NMS showed strange readings	Result is point of discussion, due to strange NMS readings	No rating

Thursday February 18th 2016

18-19	Capesize Arr Start Time 16.00 Ebb Max. NW 15,5 m/sec Sim Start 08.53 Sim Stop 09.16	Initial speed setting 4 knots (SOG). At 16.06 an aft tug failure was initiated. The pilot used the forward tug at 100% for a short moment and hard rudder and Half ahead also for a short period. He managed to make the turn, apparently without any difficulties. He stayed in control all the time and asked to bring the forward tug to the stern. This lasted 8 minutes. On finals all movements were under control.	Tug Failure	+-
18-20	Capesize Arr. Start Time 16.00 Ebb Max. SSW 15,5 m/sec Sim Start 09.30 Sim Stop	Initial speed setting 4 knots (SOG). An engine failure was initiated at 16.07. The pilot ordered the aft tug and port bow tug to pull with maximum power. The pilot decided to abort the approach. He was able to stop the vessel and gained stern speed, however the aft tug was used at full power for considerable time (9 minutes). At 16.17 the engine became available again and the pilot decided to resume the approach. All actions fully in control and safe.	Engine Failure	+-
18-21	Valemax Arr. Flowinteract Start Time 10.50 NW 15,5 m/sec Sim Start 10.28 Sim stop 10.53	Just before the pilot had to increase the ROT the engine failed. The ROT did not develop and the turn radius became too big. The ship ended parallel to the bottom profile; the simulator did not stop. So maybe it is assumable that the ship stayed afloat. Anyhow: A non safe situation.	Engine Failure	--
18-22	Valemax Arr. Flowinteract Start Time 10.50 SSW 15,5 m/sec Sim Start 11.05 Sim Stop 11.28	At 10.55 the aft tug failed. The pilot's reaction was to reduce the speed by running astern and the use of the port aft tug to develop sufficient ROT. It became a perfect well controlled run. Very safe.	Tug Failure	+
18-23	Capesize Arr. Start Time 16.00 Ebb factor 1.3 SSW 15,5 m/sec Sim start 11.41 Sim Stop 12.05 Video 035	Tug failure at 16.08. The aft tug master did not notice the problem, until the moment on which the pilot gave his first order to the aft tug. This happened at 16.14 just when the ship started to develop a ROT, because of the 2 knot ebb current. The pilot managed to control the situation by using engine and the forward tugs and regained a starboard ROT. The ship has always been under control.	Tug Failure	+-

		No eminent danger for the possibly moored ships.		
18-24	Valemax Dep Start Time 13.15 W 15,5 m/sec Current Factor 1.3 Sim start 13.25 Sim stop 14.00 Video 036	After a controlled and safe departure, the pilot decided to turn over starboard in the turning circle at the entrance of Miss. Haven. With the expected new buoy configuration, ship has touched the red buoy at the entrance. But the pilot may not be fully briefed on the new situation and the NMS readings are that of the existing situation. So an understandable mistake, but a safe passage of the moored ships.		--+
18-25	Capesize Arr. Start Time 16.00 Ebb factor 1.3 NW 15,5 m/sec Sim start 14.20 Sim Stop 14.44 Video 038	At 16.05.40 the engine broke down. The pilot used the aft tug in order to develop ROT to starboard. Due to the 2 knot current, the original Starboard ROT decreased and changed into Port ROT. Pilot handled the situation by using the port tug and aft tug. In all the approach has been conducted very well.	Engine failure	++
18-26	VLCC Arr. Start Time 10.50 W 15,5 m/sec Flood factor 1.3 Sim Start 15.07 Sim Stop 15.28	At 10.53 pilot stopped the engine and at starting the engine astern, the engine broke down. Pilot initially tried to stop, but reconsidered and decided to try and make the turn. This appeared to be a wrong decision, almost causing a grounding.	Engine failure	--

Rating

- ++ = Safe with redundancy**
- + = Safe, Redundancy questionable**
- + = Safety and redundancy critical**
- = Unsafe**
- = Very unsafe, non redundant**

APPENDIX E Questionnaires Pilots

Project 29266.600

Questionnaire voor loods

Algemeen:

Manoeuvre (scenario)/schip: Capesize T18.5

Windrichting en -snelheid: SSW 15.5 m/s

Stroombeeld: Eb 1 kn

Run no: 16 - 03

Vaarplan: (type manoeuvre): zie 16/01

Aantal te gebruiken sleepboten en waar: 2xV, 1xA

Beoordeling van verloop van de run:

Algemene indruk van run: onveilig / twijfelachtig / veilig

Controleerbaarheid tijdens de vaart: slecht / twijfelachtig / goed

Was de ruimte voldoende voor een veilige vaart? nee / twijfelachtig / ja

Was deze vaart met meer stroom uit te voeren? nee / twijfelachtig / ja

Opmerkingen:

T.a.v. Controleerbaarheid : voldoende

T.a.v. gebruik sleepboten: juist voldoende: kritieke punt is achtersleepboot

T.a.v. ruimte voor het schip: voldoende

Algemeen:

Manoeuvre (scenario)/schip: capesize T18.5 / blackout
Windrichting en -snelheid: SSW 15 m/s
Stroombeeld: Max eb
Run no: 17-15
Vaarplan: (type manoeuvre): buitenbocht / raken aan track

Aantal te gebruiken sleepboten en waar: 3x (2xV, 1xA)

Beoordeling van verloop van de run:

Algemene indruk van run: onveilig / twijfelachtig / veilig
Controleerbaarheid tijdens de vaart: slecht / twijfelachtig / goed
Was de ruimte voldoende voor een veilige vaart? nee / twijfelachtig / ja
Was deze vaart met meer stroom uit te voeren? nee / twijfelachtig / ja

Opmerkingen:

T.a.v. Controleerbaarheid : blackout in bocht nadat reeds voldoende RoT bereikt was;
dus alleen RoT te onderhouden

T.a.v. gebruik sleepboten: voldoende vermogen

T.a.v. ruimte voor het schip: net voldoende

Algemeen:

Manoeuvre (scenario)/schip: capesize invarend
Windrichting en -snelheid: ZW
Stroombeeld: eb in Beergat
Run no: 17-16
Vaarplan: (type manoeuvre): achter sleepboot valt uit, heeft nooit iets gedaan

Aantal te gebruiken sleepboten en waar:

Beoordeling van verloop van de run:

Algemene indruk van run: onveilig / twijfelachtig / veilig
Controleerbaarheid tijdens de vaart: slecht / twijfelachtig / goed
Was de ruimte voldoende voor een veilige vaart? nee / twijfelachtig / ja
Was deze vaart met meer stroom uit te voeren? nee / twijfelachtig / ja

Opmerkingen:

T.a.v. Controleerbaarheid : relatief veel vaart

T.a.v. gebruik sleepboten: weinig gebruikt

T.a.v. ruimte voor het schip: voldoende

Project 29266.600

Questionnaire voor loods

Algemeen:

Manoeuvre (scenario)/schip: Capesize naar EMO (max. eb) A-sleepboot defect

Windrichting en -snelheid:

Stroombeeld:

Run no: 18-19

Vaarplan: (type manoeuvre):

Aantal te gebruiken sleepboten en waar: 1xA 2xV

Beoordeling van verloop van de run:

Algemene indruk van run: onveilig / twijfelachtig / veilig

Controleerbaarheid tijdens de vaart: slecht / twijfelachtig / goed

Was de ruimte voldoende voor een veilige vaart? nee / twijfelachtig / ja

Was deze vaart met meer stroom uit te voeren? nee / twijfelachtig / ja

Opmerkingen:

T.a.v. Controleerbaarheid : schip bouwt minder snel RoT op dan in de praktijk

T.a.v. gebruik sleepboten:

T.a.v. ruimte voor het schip: antenne positie NMS was fout tijdens de reis

Project 29266.600

Questionnaire voor loods

Algemeen:

Manoeuvre (scenario)/schip: Capesize EMO
Windrichting en -snelheid: ZZW 50 kn
Stroombeeld: EB
Run no: 18-20
Vaarplan: (type manoeuvre): blackout thv radarscanner

Aantal te gebruiken sleepboten en waar: 1xA 2xV

Beoordeling van verloop van de run:

Algemene indruk van run: { onveilig / twijfelachtig / veilig
Controleerbaarheid tijdens de vaart: { slecht / twijfelachtig / goed
Was de ruimte voldoende voor een veilige vaart? nee / twijfelachtig / ja
Was deze vaart met meer stroom uit te voeren? nee / twijfelachtig / ja

Opmerkingen:

T.a.v. Controleerbaarheid : ivm blackout moet een keuze worden gemaakt tussen afbreken of doorgaan met dood schip. Bij afbreken bestaat de kans dat het schip niet tijdig kan worden afgestopt.

T.a.v. gebruik sleepboten:

T.a.v. ruimte voor het schip:

Algemeen:

Manoeuvre (scenario)/schip: Capesize eb

Windrichting en -snelheid: ZZW

Stroombeeld: eb

Run no: 18-23

Vaarplan: (type manoeuvre): kop voor miss.haven
Achterboot niet beschikbaar om sb draai er weer in te brengen

Aantal te gebruiken sleepboten en waar:

Beoordeling van verloop van de run:

Algemene indruk van run: onveilig / twijfelachtig / veilig

Controleerbaarheid tijdens de vaart: slecht / twijfelachtig / goed

Was de ruimte voldoende voor een veilige vaart? nee / twijfelachtig / ja

Was deze vaart met meer stroom uit te voeren? nee / twijfelachtig / ja

Opmerkingen:

T.a.v. Controleerbaarheid :

T.a.v. gebruik sleepboten:

T.a.v. ruimte voor het schip:

Project 29266.600

Questionnaire voor loods

Algemeen:

Manoeuvre (scenario)/schip: Capesize invaart eb

Windrichting en -snelheid:

Stroombeeld: EB

Run no: 18-25

Vaarplan: (type manoeuvre):

Aantal te gebruiken sleepboten en waar:

Beoordeling van verloop van de run:

Algemene indruk van run: onveilig / twijfelachtig / veilig

Controleerbaarheid tijdens de vaart: slecht / twijfelachtig / goed

Was de ruimte voldoende voor een veilige vaart? nee / twijfelachtig / ja

Was deze vaart met meer stroom uit te voeren? nee / twijfelachtig / ja

Opmerkingen:

T.a.v. Controleerbaarheid : goed

T.a.v. gebruik sleepboten: voldoende vermogen ter beschikking

T.a.v. ruimte voor het schip: voldoende

Project 29266.600

Questionnaire voor loods

Algemeen:

Manoeuvre (scenario)/schip: volle vloed, NW wind, capesizer

Windrichting en -snelheid: NW

Stroombeeld: volle vloed

Run no: 16-04

Vaarplan: (type manoeuvre):

Aantal te gebruiken sleepboten en waar:

Beoordeling van verloop van de run:

Algemene indruk van run: onveilig / twijfelachtig / veilig

Controleerbaarheid tijdens de vaart: slecht / twijfelachtig / goed

Was de ruimte voldoende voor een veilige vaart? nee / twijfelachtig / ja

Was deze vaart met meer stroom uit te voeren? nee / twijfelachtig / ja

Opmerkingen:

T.a.v. Controleerbaarheid : met weinig (1/2) sleepbootkracht in de sb beweging goed op te vangen

T.a.v. gebruik sleepboten: ruim binnen limiet

T.a.v. ruimte voor het schip: altijd voldoende

Project 29266.600

Questionnaire voor loods

Algemeen:

Manoeuvre (scenario)/schip: capesize
Windrichting en -snelheid: NW 155 m/s
Stroombeeld: Vloed 1 kn
Run no: 16-05

Vaarplan: (type manoeuvre):

Tug failure. 2xV en 1xA

Aantal te gebruiken sleepboten en waar:

Beoordeling van verloop van de run:

Algemene indruk van run: onveilig / twijfelachtig / veilig
Controleerbaarheid tijdens de vaart: slecht / twijfelachtig / goed
Was de ruimte voldoende voor een veilige vaart? nee / twijfelachtig / ja
Was deze vaart met meer stroom uit te voeren? nee / twijfelachtig / ja

Opmerkingen:

T.a.v. Controleerbaarheid : goed: tug failure moment na bereiken gewenste RoT, goed te onderhouden

T.a.v. gebruik sleepboten: 1 voorboot los en naar achterschip

T.a.v. ruimte voor het schip: voldoende

Opm: afmeren 2 sleepboten ongewenst.
(realiteit) er zou alternatieve 3^e moeten komen

Project 29266.600

Questionnaire voor loods

Algemeen:

Manoeuvre (scenario)/schip: Capesize
Windrichting en -snelheid: ZZW
Stroombeeld: laatste eb
Run no: 17-12
Vaarplan: (type manoeuvre): BB keren in zwaaicirkel

Aantal te gebruiken sleepboten en waar: 1 sleepboot center voor uitgevallen

Beoordeling van verloop van de run:

Algemene indruk van run: onveilig / twijfelachtig / veilig
Controleerbaarheid tijdens de vaart: slecht / twijfelachtig / goed
Was de ruimte voldoende voor een veilige vaart? nee / twijfelachtig / ja
Was deze vaart met meer stroom uit te voeren? nee / twijfelachtig / ja

Opmerkingen:

T.a.v. Controleerbaarheid :

T.a.v. gebruik sleepboten:

T.a.v. ruimte voor het schip: meer naar noorden verzet bij keren dan de bedoeling was.
Niet onveilig want kan altijd vluchten.

Project 29266.600

Questionnaire voor loods

Algemeen:

Manoeuvre (scenario)/schip: capesizer
Windrichting en -snelheid: NW 15 m/s
Stroombeeld: max fld
Run no: 17-13

Vaarplan: (type manoeuvre):

Aantal te gebruiken sleepboten en waar: 3x (2xV en 1xA)

Beoordeling van verloop van de run:

Algemene indruk van run: onveilig / twijfelachtig / veilig
Controleerbaarheid tijdens de vaart: slecht / twijfelachtig / goed
Was de ruimte voldoende voor een veilige vaart? nee / twijfelachtig / ja
Was deze vaart met meer stroom uit te voeren? nee / twijfelachtig / ja

Opmerkingen:

T.a.v. Controleerbaarheid : goed. (wat vaart voldoende RoT, prima te controleren)

T.a.v. gebruik sleepboten: voldoende over

T.a.v. ruimte voor het schip: juist voldoende

Project 29266.600

Questionnaire voor loods

Algemeen:

Manoeuvre (scenario)/schip: Valemax
Windrichting en -snelheid: W
Stroombeeld: vloed in Beerkanaal (HW-1)
Run no: 16-8
Vaarplan: (type manoeuvre): SB meren EMO4

Aantal te gebruiken sleepboten en waar:

Beoordeling van verloop van de run:

Algemene indruk van run: onveilig / twijfelachtig / veilig
Controleerbaarheid tijdens de vaart: slecht / twijfelachtig / goed
Was de ruimte voldoende voor een veilige vaart? nee / twijfelachtig / ja
Was deze vaart met meer stroom uit te voeren? nee / twijfelachtig / ja

Opmerkingen:

T.a.v. Controleerbaarheid :

T.a.v. gebruik sleepboten: vergissing bij het aansturen maar dit werd nog gecorrigeerd.

T.a.v. ruimte voor het schip:

Project 29266.600

Questionnaire voor loods

Algemeen:

Manoeuvre (scenario)/schip: Valemax T22.6

Windrichting en -snelheid: SSW 15 m/s

Stroombeeld: Fld

Run no: 16-9

Vaarplan: (type manoeuvre): SB meren

Aantal te gebruiken sleepboten en waar:

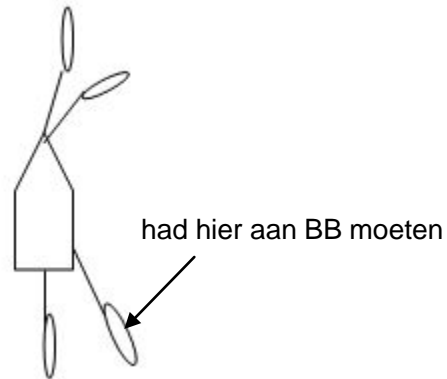

Beoordeling van verloop van de run:

Algemene indruk van run: onveilig / twijfelachtig / veilig

Controleerbaarheid tijdens de vaart: slecht / twijfelachtig / goed

Was de ruimte voldoende voor een veilige vaart? nee / twijfelachtig / ja

Was deze vaart met meer stroom uit te voeren? nee / twijfelachtig / ja

Opmerkingen:

T.a.v. Controleerbaarheid : goed

T.a.v. gebruik sleepboten: goed

T.a.v. ruimte voor het schip: voldoende XTE 30 m (slechts)
Heeft impact op te passeren/gemeerde vaart

Project 29266.600

Questionnaire voor loods

Algemeen:

Manoeuvre (scenario)/schip: Valemax T22.6 BB meren
Windrichting en -snelheid: SSW 15 m/s
Stroombeeld: 'op zoek' stil van laag
Run no: 17-11
Vaarplan: (type manoeuvre): rond BK voor missh. Over BB voorschip op wayp. 'houden'

Aantal te gebruiken sleepboten en waar: 4x (1xV, 1xA 1x SBV, 1x SBA)

Beoordeling van verloop van de run:

Algemene indruk van run: onveilig / twijfelachtig / veilig
Controleerbaarheid tijdens de vaart: slecht / twijfelachtig / goed
Was de ruimte voldoende voor een veilige vaart? nee / twijfelachtig / ja
Was deze vaart met meer stroom uit te voeren? nee / twijfelachtig / ja

Opmerkingen:

T.a.v. Controleerbaarheid : Goed. Vaart op tijd laag voor inzet zwaai. Blijkt nog. Eb uit Hartelkanaal

T.a.v. gebruik sleepboten: van 4 sleepboten veel vermogen nodig om pos te bereiken voor invaart Missh. Nu juist vloed. Invaart/doorvaart missh. weinig vermogen.

T.a.v. ruimte voor het schip: juist voldoende

Algemeen:

Manoeuvre (scenario)/schip: vloed Valemax

Windrichting en -snelheid:

Stroombeeld:

Run no: 17 - 14

Vaarplan: (type manoeuvre): sb meren EMO4

Aantal te gebruiken sleepboten en waar:

Beoordeling van verloop van de run:

Algemene indruk van run: onveilig / twijfelachtig / veilig

Controleerbaarheid tijdens de vaart: slecht / twijfelachtig / goed

Was de ruimte voldoende voor een veilige vaart? nee / twijfelachtig / ja

Was deze vaart met meer stroom uit te voeren? nee / twijfelachtig / ja

Opmerkingen:

T.a.v. Controleerbaarheid : vrij snel gevaren,

T.a.v. gebruik sleepboten: 3 boten nodig om draai te krijgen

T.a.v. ruimte voor het schip: voldoende

Project 29266.600

Questionnaire voor loods

Algemeen:

Manoeuvre (scenario)/schip: Valemax
Windrichting en -snelheid:
Stroombeeld: volle vloed
Run no: 18-21

Vaarplan: (type manoeuvre):

Aantal te gebruiken sleepboten en waar:

Beoordeling van verloop van de run:

Algemene indruk van run: onveilig / twijfelachtig / veilig
Controleerbaarheid tijdens de vaart: slecht / twijfelachtig / goed
Was de ruimte voldoende voor een veilige vaart? nee / twijfelachtig / ja
Was deze vaart met meer stroom uit te voeren? nee / twijfelachtig / ja

Opmerkingen:

T.a.v. Controleerbaarheid : vaart 4,5 knoop. Laat willen bochten, machine stopt, met sleepboten niet voldoende RoT kunnen krijgen. Schip landt net oost van oostelijke ligplaats.

T.a.v. gebruik sleepboten:

T.a.v. ruimte voor het schip:

Project 29266.600

Questionnaire voor loods

Algemeen:

Manoeuvre (scenario)/schip: Valemax / vloed

Windrichting en -snelheid:

Stroombeeld:

Run no: 18-22

Vaarplan: (type manoeuvre):

Aantal te gebruiken sleepboten en waar:

Beoordeling van verloop van de run:

Algemene indruk van run: onveilig / twijfelachtig / veilig

Controleerbaarheid tijdens de vaart: slecht / twijfelachtig / goed

Was de ruimte voldoende voor een veilige vaart? nee / twijfelachtig / ja

Was deze vaart met meer stroom uit te voeren? nee / twijfelachtig / ja

Opmerkingen:

T.a.v. Controleerbaarheid : * vaart afgebouwd tot 3kn voor het inzetten van de bocht

T.a.v. gebruik sleepboten: * CL-A sleepboot defect.
* 1x voor en 1x achter sleepboot

T.a.v. ruimte voor het schip: 50% gebruikt voor het varen van de track
* track goed gevolgd

Project 29266.600**Questionnaire voor loods**Algemeen:

Manoeuvre (scenario)/schip: Valemax ledig uitvarend

Windrichting en -snelheid: NW

Stroombeeld: slack

Run no: 17-10

Vaarplan: (type manoeuvre): keren t.h.v. 6e pet.

Aantal te gebruiken sleepboten en waar:

Beoordeling van verloop van de run:

Algemene indruk van run: onveilig / twijfelachtig / veilig

Controleerbaarheid tijdens de vaart: slecht / twijfelachtig / goed

Was de ruimte voldoende voor een veilige vaart? nee / twijfelachtig / ja

Was deze vaart met meer stroom uit te voeren? nee / twijfelachtig / ja

Opmerkingen:

T.a.v. Controleerbaarheid : goed

T.a.v. gebruik sleepboten: weinig

T.a.v. ruimte voor het schip: voldoende

Project 29266.600**Questionnaire voor loods**Algemeen:

Manoeuvre (scenario)/schip: Vale ballast dep. SB
Windrichting en -snelheid: SSW 15.5 m/s
Stroombeeld: slack
Run no: 17 / 17 + 18
Vaarplan: (type manoeuvre): rond. Kruining BK/Miss

Aantal te gebruiken sleepboten en waar: 4x (1xV, 1xA, 1x BBV, 1x BBA)

Beoordeling van verloop van de run:

Algemene indruk van run: onveilig / twijfelachtig / veilig
Controleerbaarheid tijdens de vaart: slecht / twijfelachtig / goed
Was de ruimte voldoende voor een veilige vaart? nee / twijfelachtig / ja
Was deze vaart met meer stroom uit te voeren? nee / twijfelachtig / ja

Opmerkingen:

T.a.v. Controleerbaarheid : 16:52:08 = Qastor van zijn padje!!

T.a.v. gebruik sleepboten:

T.a.v. ruimte voor het schip: 1^e run (17). Tug sim 3 error in Missh.
2e run (18) ondanks wind zeer weinig sleepboot hulp nodig in Missh.
Pos. Jump tijdens zwaai NMS

Project 29266.600

Questionnaire voor loods

Algemeen:

Manoeuvre (scenario)/schip: Valemax achteruit vertrek

Windrichting en -snelheid: West EMO4

Stroombeeld: stil water

Run no: 18-24

Vaarplan: (type manoeuvre):

Aantal te gebruiken sleepboten en waar: 4x

Beoordeling van verloop van de run:

Algemene indruk van run: onveilig / twijfelachtig / veilig

Controleerbaarheid tijdens de vaart: slecht / twijfelachtig / goed

Was de ruimte voldoende voor een veilige vaart? nee / twijfelachtig / ja

Was deze vaart met meer stroom uit te voeren? nee / twijfelachtig / ja

Opmerkingen:

T.a.v. Controleerbaarheid : vaart achteruit max 3kn. Om goed te kunnen blijven sturen

T.a.v. gebruik sleepboten: sleepboten hebben weinig ruimte om op de draad te manoeuvreren wanneer we tussen de boeien varen.

T.a.v. ruimte voor het schip: rondgaan kan beter t.h.v. 6^e pet. Bij oplijnen naar zwaaiikom is het voorschip over de nieuwe rode boei gevaren (nog niet gewend aan nieuwe positie / niet in NMS)

Project 29266.600

Questionnaire voor loods

Algemeen:

Manoeuvre (scenario)/schip: VLCC
Windrichting en -snelheid: ZZW
Stroombeeld: volle vloed
Run no: 16-6
Vaarplan: (type manoeuvre): MK uitval voordat de SB draai begon

Aantal te gebruiken sleepboten en waar:

Beoordeling van verloop van de run:

Algemene indruk van run: onveilig / twijfelachtig / veilig
Controleerbaarheid tijdens de vaart: slecht / twijfelachtig / goed
Was de ruimte voldoende voor een veilige vaart? nee / twijfelachtig / ja
Was deze vaart met meer stroom uit te voeren? nee / twijfelachtig / ja

Opmerkingen:

T.a.v. Controleerbaarheid : met relatief weinig sleepboot vermogen bocht gemaakt en gestut

T.a.v. gebruik sleepboten:

T.a.v. ruimte voor het schip:

Project 29266.600

Questionnaire voor loods

Algemeen:

Manoeuvre (scenario)/schip: VLCC T21m (blackout)

Windrichting en -snelheid: NW 15 m/s

Stroombeeld: Fld 1 kn (in BK)

Run no: 16-07

Vaarplan: (type manoeuvre):

SOG aanvang 5 kn. BB meren T.Terminal 1xV, 1xA, 1x SBV, 1xSBA

Aantal te gebruiken sleepboten en waar:

Beoordeling van verloop van de run:

Algemene indruk van run: onveilig / twijfelachtig / veilig

Controleerbaarheid tijdens de vaart: slecht / twijfelachtig / goed

Was de ruimte voldoende voor een veilige vaart? nee / twijfelachtig / ja

Was deze vaart met meer stroom uit te voeren? nee / twijfelachtig / ja

Opmerkingen:

T.a.v. Controleerbaarheid : vóór inzet zwaai vaart omlaag tot < 3 kn (anders keuze grintbak onder LL)

T.a.v. gebruik sleepboten: na MK uitval 3x 100% rem. RoT opbouw op lage snelheid mogelijk

T.a.v. ruimte voor het schip: voldoende

Project 29266.600

Questionnaire voor loods

Algemeen:

Manoeuvre (scenario)/schip: VLCC inbound

Windrichting en -snelheid:

Stroombeeld: vloed

Run no: 26

Vaarplan: (type manoeuvre):

Aantal te gebruiken sleepboten en waar:

Beoordeling van verloop van de run:

Algemene indruk van run: onveilig / twijfelachtig / veilig

Controleerbaarheid tijdens de vaart: slecht / twijfelachtig / goed

Was de ruimte voldoende voor een veilige vaart? nee / twijfelachtig / ja

Was deze vaart met meer stroom uit te voeren? nee / twijfelachtig / ja

Opmerkingen:

T.a.v. Controleerbaarheid : aanvangsvaart was hoog. Machine reageert niet wanneer deze achteruit moet starten. Met 3 sleepboten geprobeerd de vaart te verminderen voorafgaand aan het inzetten van de bocht naar SB. De vaart gaat niet omlaag. Hierna met alle sleepboten RoT naar SB opbouwen maar dit lukt onvoldoende. Schip vaart over rode boei.

T.a.v. gebruik sleepboten:

T.a.v. ruimte voor het schip: